



ROBO Cylinder RCS2/RCS3 Actuators Slider Type Operating Manual

Twenty-first Edition

Standard Type Motor Straight Type(Coupling Type):	RCS2- SA4C, SA5C, SA6C, SA7C, SS7C, SS8C RCS3- SA8C, SS8C
Standard Type Motor Straight Type (Built-in Type):	RCS2- SA4D, SA5D, SA6D
Standard Type Motor Reversing Type:	RCS2- SA4R, SA5R, SA6R, SA7R, SS7R, SS8R RCS3- SA8R, SS8R
Cleanroom Type Motor Straight Type(Coupling Type):	RCS2CR- SA4C, SA5C, SA6C, SA7C, SS7C, SS8C RCS3CR- SA8C, SS8C
Cleanroom Type Motor Straight Type(Built-in Type):	RCS2CR- SA5D, SA6D
High-precision Type Motor Straight Type (Coupling Type):	RCS3P- SA8C, SS8C, SA8R, SS8R
High-precision Cleanroom Type Motor Straight Type(Coupling Type):	RCS3PCR- SA8C, SS8C

IAI America, Inc.

Please Read Before Use

Thank you for purchasing our product.

This Operation Manual describes all necessary information to operate this product safely such as the operation procedure, structure and maintenance procedure.

Before operation, read this manual carefully and fully understand it to operate this product safely. The enclosed CD or DVD in this product package includes the Operation Manual for this product. For the operation of this product, print out the necessary sections in the Operation Manual or display them using the personal computer.

After reading through this manual, keep this Operation Manual at hand so that the operator of this product can read it whenever necessary.

[Important]

- This Operation Manual is original.
- The product cannot be operated in any way unless expressly specified in this Operation Manual. IAI shall assume no responsibility for the outcome of any operation not specified herein.
- Information contained in this Operation Manual is subject to change without notice for the purpose of product improvement.
- If you have any question or comment regarding the content of this manual, please contact the IAI sales office near you.
- Using or copying all or part of this Operation Manual without permission is prohibited.
- The company names, names of products and trademarks of each company shown in the sentences are registered trademarks.

Greasing Actuators of Cleanroom Specification

For ROBO Cylinder actuators of cleanroom specification, use grease of low-dust-raising type for cleanroom applications.

The grease specified in the maintenance/inspection sections of the Operating Manual is for actuators of standard specification.

Using the grease for the standard actuators on the cleanroom actuators may generate dust.

**Recommended grease: C Grease by Kuroda
Precision Industries Ltd.**

C Grease by Kuroda Precision Industries is applied to the cleanroom actuators before shipment from IAI.

Table of Contents

Safety Guide	1
Handling Precautions.....	8
International Standards Compliances.....	13
Names of the Parts	14
1. Checking the Product	23
1.1 Components	23
1.2 Operation Manuals for Controllers Supported by This Product.....	23
1.3 How to Read the Model Nameplate.....	25
1.4 How to Read the Model Number	26
1.4.1 RCS2.....	26
1.4.2 RCS3.....	27
2. Specification	28
3. Life.....	43
4. Installation and Storage/Preservation Environment.....	44
4.1 Installation Environment	44
4.2 Storage/Preservation Environment.....	44
5. Installation	45
5.1 Installation	45
5.2 Notes on Installation	47
5.3 Installing the Actuator	48
5.3.1 Using the Tapped Holes at Back of the Base	49
5.3.2 Using the Mounting Holes on Top of the Base.....	51
5.3.3 Using Foot Bases (Optional).....	52
5.4 Installation Surface	53
5.4.1 Using Side Faces of the Base as Reference Planes	53
5.4.2 Using Side Faces of the Foot Base as Reference Planes.....	55
5.5 Tightening Screws	56
5.6 Installing the Load on the Slider	57
5.6.1 Using the Slider.....	57
5.6.2 Using a Slider Spacer (Optional).....	59
5.7 Cleanroom Specification.....	60
5.7.1 Suction Rate.....	60
5.7.2 Suction Joint.....	60
6. Connection with Controllers.....	61
6.1 Wiring	61

7.	Setting the Home.....	64
7.1	Home Return	64
7.2	Fine-tuning the Home Position	64
7.3	Changing the Direction of Home.....	64
7.4	How to Use the Home Mark	65
7.5	How to Set the Home Preset and Home Return Offset	66
7.5.1	X-SEL or SSEL Controller	66
7.5.2	ECON or SCON Controller	69
8.	Slit for Position Adjustment.....	72
9.	Options	73
9.1	Brake	73
9.2	Foot Bracket	73
9.3	High Acceleration/Deceleration Option	74
9.4	Home Check Sensor	74
9.5	Reversed Home Specification	74
9.6	Slider Roller Specification.....	74
9.7	Slider Spacer	74
9.8	Motor Reversed to Left, Motor Reversed to Right	75
9.9	Changing the Cable Exit Direction.....	75
9.10	Changing the Motor Reversing Direction (Left/Right) and Cable Exit Direction	75
9.11	Suction Joint on Opposite Side.....	76
9.12	No Suction Joint	76
10.	Motor/Encoder Cables.....	77
11.	Maintenance and Inspection.....	79
11.1	Inspection Items and Schedule.....	79
11.2	Visual Inspection of the Machine Exterior.....	79
11.3	Cleaning	80
11.4	Adjusting the Stainless Sheet	80
11.5	Interior Inspection	81
11.6	Internal Cleaning	88
11.7	Adding Grease.....	88
11.7.1	Applicable Grease.....	88
11.7.2	How to Apply Grease to RCS2.....	90
11.7.3	How to Apply Grease to the RCS3(P)(CR).....	91
11.8	Replacing/Adjusting the Stainless Sheet	93
11.8.1	RCS2, RCS3(P)-SS8, RCS3(P)CR-SS8	93
11.8.2	RCS3(P)CR-SA8C	98

11.9	Reduction Belt [Motor Reversing Type]	102
11.9.1	Inspecting the Belt	102
11.9.2	Applicable Belt	102
11.9.3	Adjusting the Belt Tension (SA4R, SA5R, SA6R).....	102
11.9.4	Adjusting the Belt Tension (RCS2-SA7R).....	103
11.9.5	Adjusting the Belt Tension (RCS2-SS7R, SS8R)	103
11.9.6	Replacing the Belt of the Motor Reversing Type (RCS2-SA4R, SA5R, SA6R).....	104
11.9.7	Replacing the Belt of the Motor Reversing Type (RCS2-SA7R).....	110
11.9.8	Replacing the Belt of the Motor Reversing Type (RCS2-SS7R, SS8R)	113
11.10	Replacing the Motor	116
11.10.1	Replacing the Motor of the Motor Straight Type (Coupling Type) (Made by IAI) : RCS2-SA4C, SA5C, SA6C	116
11.10.2	Replacing the Motor of the Motor Straight Type (Coupling Type) (Not Made by IAI).....	126
11.10.3	Replacing the Motor of the Motor Straight Type (Coupling Type).....	138
11.10.4	Replacing the Motor of the Motor Straight Type (Coupling Type) : RCS2-SS7C, SS8C	144
11.10.5	Replacing the Motor of the Motor Reversing Type: RCS2-SA4R, SA5R, SA6R	164
11.10.6	Replacing the Motor of the Motor Reversing Type: RCS2-SA7R.....	174
11.10.7	Replacing the Motor of the Motor Reversing Type: RCS3 (P)- SA8R, SS8R.....	178
11.10.8	Replacing the Motor of the Motor Reversing Type: RCS2-SS7R, SS8R.....	184
11.10.9	Replacing the Motor of the Motor Straight Type (Coupling Type) : RCS3 (P)-SA8C, RCS3 (P) CR-SA8C.....	189
11.10.10	Replacing the Motor of the Motor Straight Type (Coupling Type) : RCS3 (P)-SS8C	200
11.10.11	Replacing the Motor of the Motor Straight Type (Built-in Type).....	212
12.	Appendix	213
12.1	External Dimensions.....	213
12.1.1	RCS2-SA4C	213
12.1.2	RCS2-SA5C	214
12.1.3	RCS2-SA6C	215
12.1.4	RCS2-SA7C	216
12.1.5	RCS2-SS7C	217
12.1.6	RCS2-SS8C	218
12.1.7	RCS2-SA4D	219
12.1.8	RCS2-SA5D	220
12.1.9	RCS2-SA6D	221
12.1.10	RCS2-SA4R	222
12.1.11	RCS2-SA5R	223
12.1.12	RCS2-SA6R	224
12.1.13	RCS2-SA7R	225
12.1.14	RCS2-SS7R	226
12.1.15	RCS2-SS8R	227
12.1.16	RCS2CR-SA4C.....	228
12.1.17	RCS2CR-SA5C.....	229
12.1.18	RCS2CR-SA6C.....	230
12.1.19	RCS2CR-SA7C.....	231
12.1.20	RCS2CR-SS7C.....	232
12.1.21	RCS2CR-SS8C.....	233
12.1.22	RCS2CR-SA5D.....	234

12.1.23	RCS2CR-SA6D.....	235
12.1.24	RCS3-SA8C, RCS3P-SA8C	236
12.1.25	RCS3-SS8C, RCS3P-SS8C	237
12.1.26	RCS3CR-SA8C, RCS3PCR-SA8C.....	238
12.1.27	RCS3CR-SS8C, RCS3PCR-SS8C.....	239
12.1.28	RCS3/RCS3P-SA8R.....	240
12.1.29	RCS3/RCS3P-SA8R Slider Roller Specification (Option Model Number: SR).....	241
12.1.30	RCS3/RCS3P-SS8R.....	242
12.1.31	RCS3/RCS3P-SS8R Slider Roller Specification (Option Model Number: SR).....	243
13.	Warranty	244
13.1	Warranty Period	244
13.2	Scope of Warranty	244
13.3	Honoring Warranty.....	244
13.4	Limited Liability	244
13.5	Conditions of Conformance with Applicable Standards/Regulations, Etc., and Applications.....	245
13.6	Other Items Excluded from Warranty.....	245
	Change History	246

Safety Guide

“Safety Guide” has been written to use the machine safely and so prevent personal injury or property damage beforehand. Make sure to read it before the operation of this product.

Safety Precautions for Our Products

The common safety precautions for the use of any of our robots in each operation.

No.	Operation Description	Description
1	Model Selection	<ul style="list-style-type: none"> ● This product has not been planned and designed for the application where high level of safety is required, so the guarantee of the protection of human life is impossible. Accordingly, do not use it in any of the following applications. <ol style="list-style-type: none"> 1) Medical equipment used to maintain, control or otherwise affect human life or physical health. 2) Mechanisms and machinery designed for the purpose of moving or transporting people (For vehicle, railway facility or air navigation facility) 3) Important safety parts of machinery (Safety device, etc.) ● Do not use the product outside the specifications. Failure to do so may considerably shorten the life of the product. ● Do not use it in any of the following environments. <ol style="list-style-type: none"> 1) Location where there is any inflammable gas, inflammable object or explosive 2) Place with potential exposure to radiation 3) Location with the ambient temperature or relative humidity exceeding the specification range 4) Location where radiant heat is added from direct sunlight or other large heat source 5) Location where condensation occurs due to abrupt temperature changes 6) Location where there is any corrosive gas (sulfuric acid or hydrochloric acid) 7) Location exposed to significant amount of dust, salt or iron powder 8) Location subject to direct vibration or impact ● For an actuator used in vertical orientation, select a model which is equipped with a brake. If selecting a model with no brake, the moving part may drop when the power is turned OFF and may cause an accident such as an injury or damage on the work piece.

No.	Operation Description	Description
2	Transportation	<ul style="list-style-type: none"> ● When carrying a heavy object, do the work with two or more persons or utilize equipment such as crane. ● When the work is carried out with 2 or more persons, make it clear who is to be the leader and who to be the follower(s) and communicate well with each other to ensure the safety of the workers. ● When in transportation, consider well about the positions to hold, weight and weight balance and pay special attention to the carried object so it would not get hit or dropped. ● Transport it using an appropriate transportation measure. The actuators available for transportation with a crane have eyebolts attached or there are tapped holes to attach bolts. Follow the instructions in the operation manual for each model. ● Do not step or sit on the package. ● Do not put any heavy thing that can deform the package, on it. ● When using a crane capable of 1t or more of weight, have an operator who has qualifications for crane operation and sling work. ● When using a crane or equivalent equipments, make sure not to hang a load that weighs more than the equipment's capability limit. ● Use a hook that is suitable for the load. Consider the safety factor of the hook in such factors as shear strength. ● Do not get on the load that is hung on a crane. ● Do not leave a load hung up with a crane. ● Do not stand under the load that is hung up with a crane.
3	Storage and Preservation	<ul style="list-style-type: none"> ● The storage and preservation environment conforms to the installation environment. However, especially give consideration to the prevention of condensation. ● Store the products with a consideration not to fall them over or drop due to an act of God such as earthquake.
4	Installation and Start	<p>(1) Installation of Robot Main Body and Controller, etc.</p> <ul style="list-style-type: none"> ● Make sure to securely hold and fix the product (including the work part). A fall, drop or abnormal motion of the product may cause a damage or injury. Also, be equipped for a fall-over or drop due to an act of God such as earthquake. ● Do not get on or put anything on the product. Failure to do so may cause an accidental fall, injury or damage to the product due to a drop of anything, malfunction of the product, performance degradation, or shortening of its life. ● When using the product in any of the places specified below, provide a sufficient shield. <ol style="list-style-type: none"> 1) Location where electric noise is generated 2) Location where high electrical or magnetic field is present 3) Location with the mains or power lines passing nearby 4) Location where the product may come in contact with water, oil or chemical droplets

No.	Operation Description	Description
4	Installation and Start	<p>(2) Cable Wiring</p> <ul style="list-style-type: none"> ● Use our company's genuine cables for connecting between the actuator and controller, and for the teaching tool. ● Do not scratch on the cable. Do not bend it forcibly. Do not pull it. Do not coil it around. Do not insert it. Do not put any heavy thing on it. Failure to do so may cause a fire, electric shock or malfunction due to leakage or continuity error. ● Perform the wiring for the product, after turning OFF the power to the unit, so that there is no wiring error. ● When the direct current power (+24V) is connected, take the great care of the directions of positive and negative poles. If the connection direction is not correct, it might cause a fire, product breakdown or malfunction. ● Connect the cable connector securely so that there is no disconnection or looseness. Failure to do so may cause a fire, electric shock or malfunction of the product. ● Never cut and/or reconnect the cables supplied with the product for the purpose of extending or shortening the cable length. Failure to do so may cause the product to malfunction or cause fire. <p>(3) Grounding</p> <ul style="list-style-type: none"> ● The grounding operation should be performed to prevent an electric shock or electrostatic charge, enhance the noise-resistance ability and control the unnecessary electromagnetic radiation. ● For the ground terminal on the AC power cable of the controller and the grounding plate in the control panel, make sure to use a twisted pair cable with wire thickness 0.5mm² (AWG20 or equivalent) or more for grounding work. For security grounding, it is necessary to select an appropriate wire thickness suitable for the load. Perform wiring that satisfies the specifications (electrical equipment technical standards). ● Perform Class D Grounding (former Class 3 Grounding with ground resistance 100Ω or below).





No.	Operation Description	Description
4	Installation and Start	<p>(4) Safety Measures</p> <ul style="list-style-type: none"> ● When the work is carried out with 2 or more persons, make it clear who is to be the leader and who to be the follower(s) and communicate well with each other to ensure the safety of the workers. ● When the product is under operation or in the ready mode, take the safety measures (such as the installation of safety and protection fence) so that nobody can enter the area within the robot's movable range. When the robot under operation is touched, it may result in death or serious injury. ● Make sure to install the emergency stop circuit so that the unit can be stopped immediately in an emergency during the unit operation. ● Take the safety measure not to start up the unit only with the power turning ON. Failure to do so may start up the machine suddenly and cause an injury or damage to the product. ● Take the safety measure not to start up the machine only with the emergency stop cancellation or recovery after the power failure. Failure to do so may result in an electric shock or injury due to unexpected power input. ● When the installation or adjustment operation is to be performed, give clear warnings such as "Under Operation; Do not turn ON the power!" etc. Sudden power input may cause an electric shock or injury. ● Take the measure so that the work part is not dropped in power failure or emergency stop. ● Wear protection gloves, goggle or safety shoes, as necessary, to secure safety. ● Do not insert a finger or object in the openings in the product. Failure to do so may cause an injury, electric shock, damage to the product or fire. ● When releasing the brake on a vertically oriented actuator, exercise precaution not to pinch your hand or damage the work parts with the actuator dropped by gravity.
5	Teaching	<ul style="list-style-type: none"> ● When the work is carried out with 2 or more persons, make it clear who is to be the leader and who to be the follower(s) and communicate well with each other to ensure the safety of the workers. ● Perform the teaching operation from outside the safety protection fence, if possible. In the case that the operation is to be performed unavoidably inside the safety protection fence, prepare the "Stipulations for the Operation" and make sure that all the workers acknowledge and understand them well. ● When the operation is to be performed inside the safety protection fence, the worker should have an emergency stop switch at hand with him so that the unit can be stopped any time in an emergency. ● When the operation is to be performed inside the safety protection fence, in addition to the workers, arrange a watchman so that the machine can be stopped any time in an emergency. Also, keep watch on the operation so that any third person can not operate the switches carelessly. ● Place a sign "Under Operation" at the position easy to see. ● When releasing the brake on a vertically oriented actuator, exercise precaution not to pinch your hand or damage the work parts with the actuator dropped by gravity. <p>* Safety protection Fence : In the case that there is no safety protection fence, the movable range should be indicated.</p>

No.	Operation Description	Description
6	Trial Operation	<ul style="list-style-type: none"> ● When the work is carried out with 2 or more persons, make it clear who is to be the leader and who to be the follower(s) and communicate well with each other to ensure the safety of the workers. ● After the teaching or programming operation, perform the check operation one step by one step and then shift to the automatic operation. ● When the check operation is to be performed inside the safety protection fence, perform the check operation using the previously specified work procedure like the teaching operation. ● Make sure to perform the programmed operation check at the safety speed. Failure to do so may result in an accident due to unexpected motion caused by a program error, etc. ● Do not touch the terminal block or any of the various setting switches in the power ON mode. Failure to do so may result in an electric shock or malfunction.
7	Automatic Operation	<ul style="list-style-type: none"> ● Check before starting the automatic operation or rebooting after operation stop that there is nobody in the safety protection fence. ● Before starting automatic operation, make sure that all peripheral equipment is in an automatic-operation-ready state and there is no alarm indication. ● Make sure to operate automatic operation start from outside of the safety protection fence. ● In the case that there is any abnormal heating, smoke, offensive smell, or abnormal noise in the product, immediately stop the machine and turn OFF the power switch. Failure to do so may result in a fire or damage to the product. ● When a power failure occurs, turn OFF the power switch. Failure to do so may cause an injury or damage to the product, due to a sudden motion of the product in the recovery operation from the power failure.

No.	Operation Description	Description
8	Maintenance and Inspection	<ul style="list-style-type: none"> ● When the work is carried out with 2 or more persons, make it clear who is to be the leader and who to be the follower(s) and communicate well with each other to ensure the safety of the workers. ● Perform the work out of the safety protection fence, if possible. In the case that the operation is to be performed unavoidably inside the safety protection fence, prepare the “Stipulations for the Operation” and make sure that all the workers acknowledge and understand them well. ● When the work is to be performed inside the safety protection fence, basically turn OFF the power switch. ● When the operation is to be performed inside the safety protection fence, the worker should have an emergency stop switch at hand with him so that the unit can be stopped any time in an emergency. ● When the operation is to be performed inside the safety protection fence, in addition to the workers, arrange a watchman so that the machine can be stopped any time in an emergency. Also, keep watch on the operation so that any third person can not operate the switches carelessly. ● Place a sign “Under Operation” at the position easy to see. ● For the grease for the guide or ball screw, use appropriate grease according to the Operation Manual for each model. ● Do not perform the dielectric strength test. Failure to do so may result in a damage to the product. ● When releasing the brake on a vertically oriented actuator, exercise precaution not to pinch your hand or damage the work parts with the actuator dropped by gravity. ● The slider or rod may get misaligned OFF the stop position if the servo is turned OFF. Be careful not to get injured or damaged due to an unnecessary operation. ● Pay attention not to lose the cover or untightened screws, and make sure to put the product back to the original condition after maintenance and inspection works. <p>Use in incomplete condition may cause damage to the product or an injury.</p> <p>* Safety protection Fence : In the case that there is no safety protection fence, the movable range should be indicated.</p>
9	Modification and Dismantle	<ul style="list-style-type: none"> ● Do not modify, disassemble, assemble or use of maintenance parts not specified based at your own discretion.
10	Disposal	<ul style="list-style-type: none"> ● When the product becomes no longer usable or necessary, dispose of it properly as an industrial waste. ● When removing the actuator for disposal, pay attention to drop of components when detaching screws. ● Do not put the product in a fire when disposing of it. The product may burst or generate toxic gases.
11	Other	<ul style="list-style-type: none"> ● Do not come close to the product or the harnesses if you are a person who requires a support of medical devices such as a pacemaker. Doing so may affect the performance of your medical device. ● See Overseas Specifications Compliance Manual to check whether complies if necessary. ● For the handling of actuators and controllers, follow the dedicated operation manual of each unit to ensure the safety.

Alert Indication

The safety precautions are divided into “Danger”, “Warning”, “Caution” and “Notice” according to the warning level, as follows, and described in the Operation Manual for each model.

Level	Degree of Danger and Damage	Symbol
Danger	This indicates an imminently hazardous situation which, if the product is not handled correctly, will result in death or serious injury.	 Danger
Warning	This indicates a potentially hazardous situation which, if the product is not handled correctly, could result in death or serious injury.	 Warning
Caution	This indicates a potentially hazardous situation which, if the product is not handled correctly, may result in minor injury or property damage.	 Caution
Notice	This indicates lower possibility for the injury, but should be kept to use this product properly.	 Notice

Handling Precautions

1. Do not set a speed or acceleration/deceleration exceeding the applicable rating.

Do not set a speed or acceleration/deceleration exceeding the applicable rating. Doing so may result in vibration, failure or shorter life. If an acceleration/deceleration exceeding the rating is set, creep may occur or the coupling may slip.

2. Keep the load moments to within the allowable value.

Keep the load moments to within the allowable value. If a load exceeding the allowable load moment is applied, the life of the actuator may be reduced. In an extreme case, even flaking may occur.

3. Keep the overhang length to within the allowable value.

Keep the overhang length of the load to within the allowable value. If the overhang length exceeds the allowable value, vibration or noise may occur.

4. Grease film may run out after back-and-forth operations over a short distance.

Grease film may run out if the actuator is moved back and forth continuously over a distance of 30 mm or less. As a guide, perform a back-and-forth operation five times or over a distance of 50 mm or more after a back-and-forth operation over such short distance has been repeated 5,000 to 10,000 times. This will restore oil film.

5. The noise of the high-acceleration type during operation may get louder compared to the standard type in some conditions.

6. Make sure to attach the actuator properly by following this operation manual.

Using the product with the actuator not being certainly retained or affixed may cause abnormal noise, vibration, malfunction or shorten the product life.

7. Perform operation with the duty ratio at the allowable value or less.

Duty ratio is the operation rate, in time basis, of the actuator in 1 cycle that is indicated with “%” .

 **Caution:** If an overload error occurs, extend the stopped time to lower the duty or decrease the acceleration/deceleration speed.

[How to Calculate Duty]

Figure out the load rate and acceleration/deceleration speed time ratio by calculation and read the duty ratio from the graph.

When the load rate is less than 50%, an operation with 100% duty ratio should be available.

[1] Load factor LF

It is described in 2. Specifications regarding the maximum transportable weight at the rated acceleration and rated acceleration/deceleration.

$$\text{Load factor : LF} = \frac{M \times \alpha}{M_r \times \alpha_r} (\%)$$

Maximum transportable weight at the rated acceleration : M_r (kg)

Rated acceleration/deceleration : α_r (G)

Transferring mass during operation : M (kg)

Acceleration/deceleration during operation : α (G)

[2] Acceleration/deceleration time ratio t_{od}

$$\text{Acceleration/deceleration time ratio } t_{od} = \frac{\text{Acceleration time during operation} + \text{Deceleration time during operation}}{\text{Operating time}} (\%)$$

$$\text{Acceleration time} = \frac{\text{Velocity at operation (mm/s)}}{\text{Acceleration during operation (mm/s}^2)} (\text{sec.})$$

$$\text{Deceleration time} = \frac{\text{Velocity at operation (mm/s)}}{\text{Deceleration during operation (mm/s}^2)} (\text{sec.})$$

$$\text{Acceleration (mm/s}^2) = \text{Acceleration (G)} \times 9,800 \text{mm/s}^2$$

$$\text{Deceleration (mm/s}^2) = \text{Deceleration (G)} \times 9,800 \text{mm/s}^2$$

[3] Read the duty ratio from the load rate LF and the acceleration speed time ratio t_{od} that were used to figure out the duty ratio.

Example) If the load factor LF is 80% and acceleration/deceleration time ratio t_{od} is 80%, the reference duty is approx. 75%.

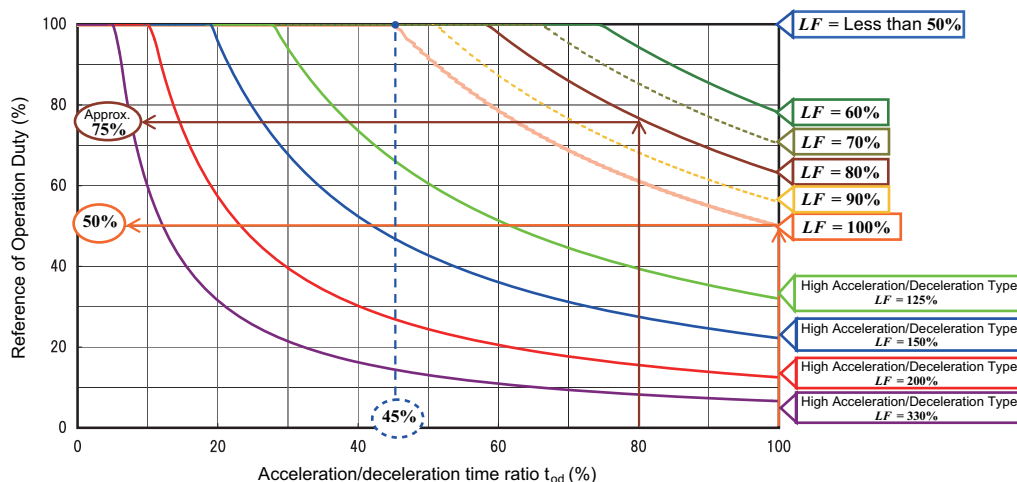

8. Do Not Loosen the Mounting Screws of Micro-Switches or Bend the Switch Dogs.

On actuators with a switch (option), the switch is stored inside the actuator body. (The switch can be accessed by removing the side covers.)

Microswitch and switch dog are adjusted to the optimal positions before shipment.

Do not loosen the mounting screws or bend the switch dog.

If the mounting screws are loosened or switch dog is bent, the optimal positions will be lost and the switch may not demonstrate its intended function.

Do not increase the homing speed beyond the default factory setting.

If the homing speed is increased beyond the default, the switch may be damaged.

Do not move the slider toward the mechanical end from the home position other than during homing.

If the actuator is moved manually or at high speed by jogging, etc., and the switch dog contacts the microswitch as a result, the switch may be damaged.

When moving the slider manually toward the mechanical end during motor replacement, etc., move the slider slowly.

When changing the home direction after shipment (such as when a need arises to move the factory-set home position to the opposite side due to a specification change, etc.), the microswitch position and switch dog must be readjusted.

Should you require such adjustment, contact the IAI sales office near you.

If the side covers were removed for maintenance, etc., be careful not to pinch the switch cables when reinstalling the covers.

In particular, pay attention when the home is set on the opposite side, because the switch cables are stored in the space between a side cover and the base.

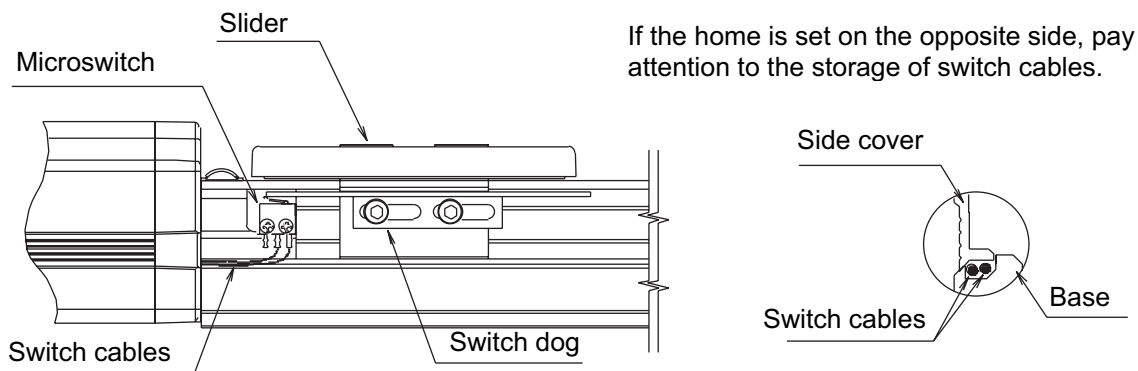

9. Transporting and Handling

9.1 Handling the Actuator

9.1.1 Handling the Packed Unit

Unless otherwise specified, each actuator (axis) is shipped individually. Please take care that the shipping box is not dropped or subjected to strong impact during transport.

- The operator should not carry heavy shipping boxes by themselves.
- If the shipping box is left standing, it should be in a horizontal position.
- Do not climb on top of the shipping box.
- Do not place heavy objects on top of the shipping box.

9.1.2 Handling the Actuator After It is Unpacked

Lift the actuator up by the base to remove it from the packing.

- When carrying the actuator, take care not to bump it. Take particular care with the front cover and motor cover.
- Do not exert excessive force on any part of the actuator.
- Be careful not to cause the cables to receive a tensile force.

- **Note on handling the stainless sheet**

The stainless sheet is designed very thin (thickness: Approx. 0.1 mm) in order to ensure flexibility. Therefore, the stainless sheet is easily dented or scratched. Once dented or scratched, the stainless sheet may break during use.



Warning: Do not press the sheet directly with hands.

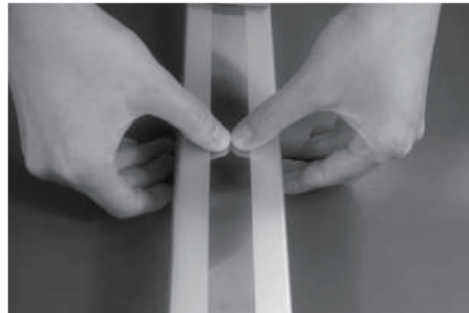

Supplement) Please refer to "Names of Parts" for the names of the actuator parts.

9.2 Handling the Actuator Assembly

Pay attention to the following instructions when transporting an assembly of actuator axes.

9.2.1 Condition of Shipment from IAI (Assembled)

The actuators you have ordered are assembled at IAI, after which the assembly receives a shipping inspection and is shipped in an outer frame with skids.

The assembly is packed with the sliders securely affixed so that they will not move unexpectedly during transportation. In the case of a combined unit, the actuator ends are secured to prevent swinging due to external vibration.

- The package is not designed with special considerations for protection against impact due to dropping or collision, so please handle the package with care. Also, do not place any heavy object on the outer frame, as it is not strong enough to withstand loads.
- When suspending the package using ropes, etc., pass the ropes from underneath the reinforcement frames at the bottom of the skids. When lifting with a forklift, also place the forks underneath the skids.
- Set down the package carefully so as not to apply impact to the assembly or cause it to bounce.

After unpacking, handle the actuator assembly correctly by observing the instructions given below.

9.2.2 Handling after Assembly with Peripheral Equipment

When transporting the actuators that have been assembled with peripheral equipment either at IAI or on your site, observe the instructions given below.

- Secure each slider to prevent unexpected movement during transportation.
- If any actuator end is protruding, secure it to prevent swinging due to external vibration.
- If the actuator ends are not secured, do not apply any impact force exceeding 0.3 G during transportation.
- When suspending the actuator-assembled peripheral equipment using ropes, etc., make sure the ropes do not contact the actuators directly.
- Pass the ropes over appropriate cushion materials, and make sure the loads from the ropes will be received by the base of each actuator.
- Secure the end of the Y-axis using a separate rope to maintain the axis in a stable horizontal position. At this time, be careful not to apply loads on the screw cover.
- Be careful not to allow the brackets, covers and connector box of each actuator to receive loads. Also protect the cables from pinching or excessive deformation.

International Standards Compliances

This actuator complies with the following overseas standard.

Refer to Overseas Standard Compliance Manual (ME0287) for more detailed information.

RoHS Directive	CE Marking
○	Optional

Names of the Parts

The names of the actuator parts are indicated below.

The left and right sides are indicated by looking at the actuator from the motor end with the actuator set down horizontally. Front end means the side opposite the motor end.

1. Motor Straight Type (Standard) RCS2

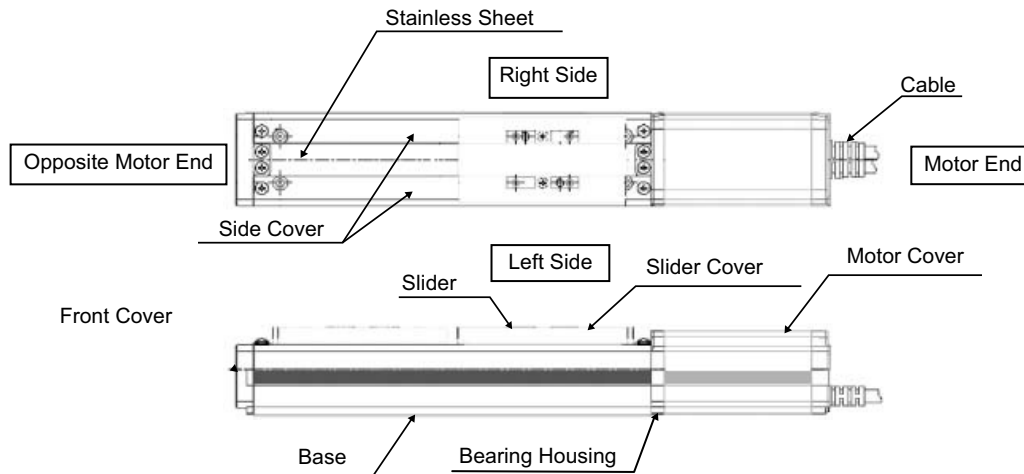

Caution: The cable directly connected to the actuator is not robot cable even when ordered with robot cable option. When designing, please be sure not to give repeated bending loads to this cable.
The robot cable is applicable only to the connecting cables.

- Coupling Type (SA7C, SS7C, SS8C)

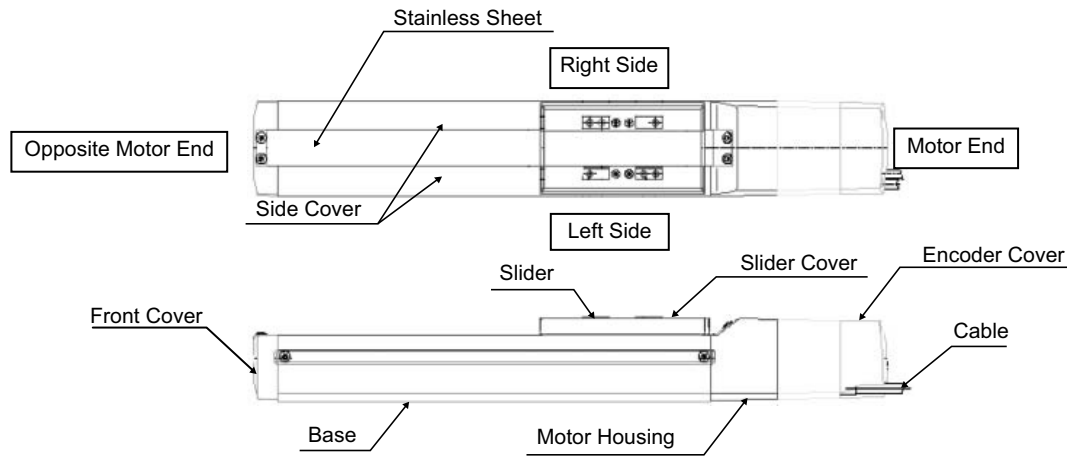

! Caution: The cable directly connected to the actuator is not robot cable even when ordered with robot cable option. When designing, please be sure not to give repeated bending loads to this cable.
The robot cable is applicable only to the connecting cables.

- Built-in Type (SA4D, SA5D, SA6D)

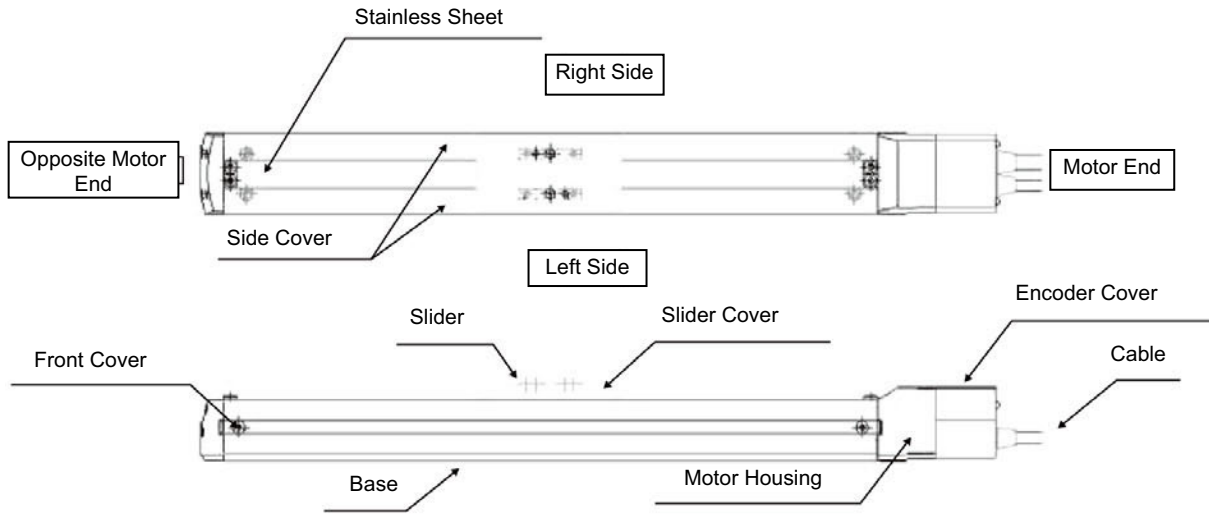

Caution: The cable directly connected to the actuator is not robot cable even when ordered with robot cable option. When designing, please be sure not to give repeated bending loads to this cable. The robot cable is applicable only to the connecting cables.

2. Motor Straight Type (Standard) RCS3(P)

- **Coupling Type (SA8)**

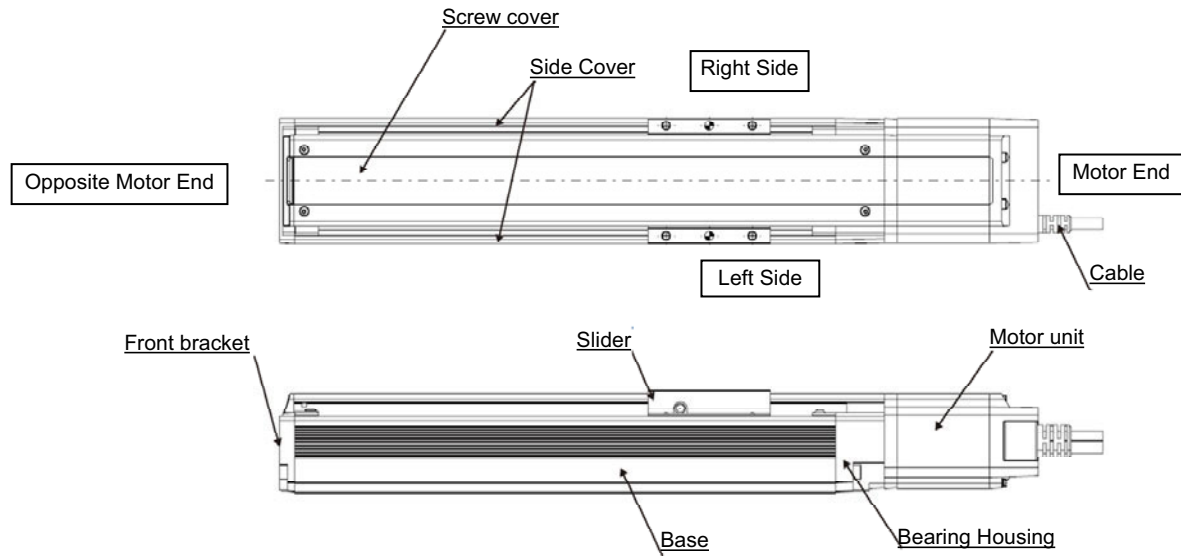

- **Coupling Type (SS8)**

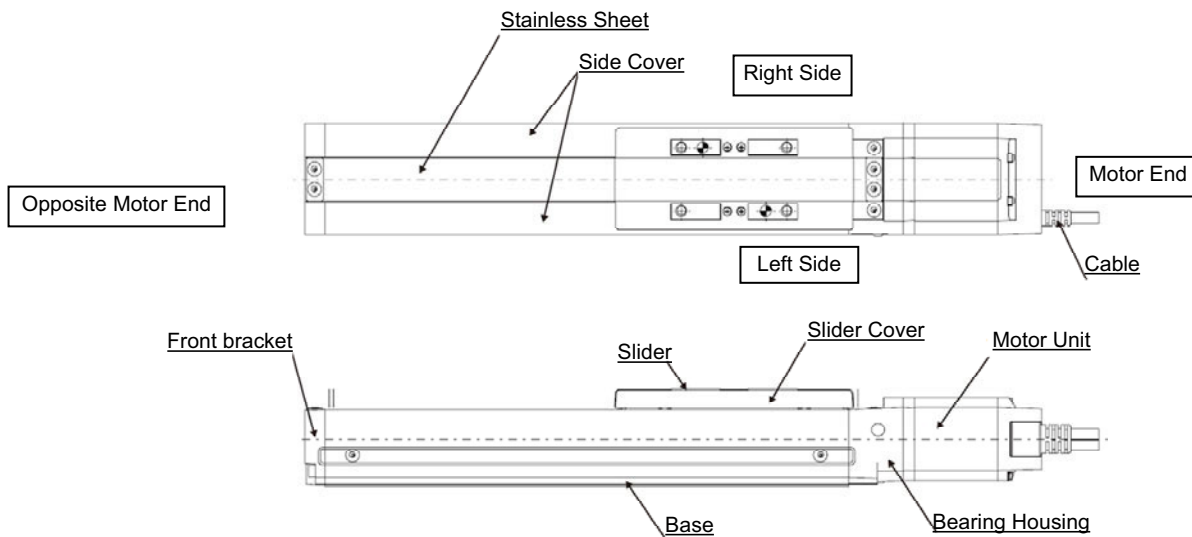

3. Motor Straight Type (Cleanroom Specification) RCS2-CR

- Coupling Type (SA4C, SA5C, SA6C, SA7C, SS7C, SS8C), Built-in Type (SA5D, SA6D)

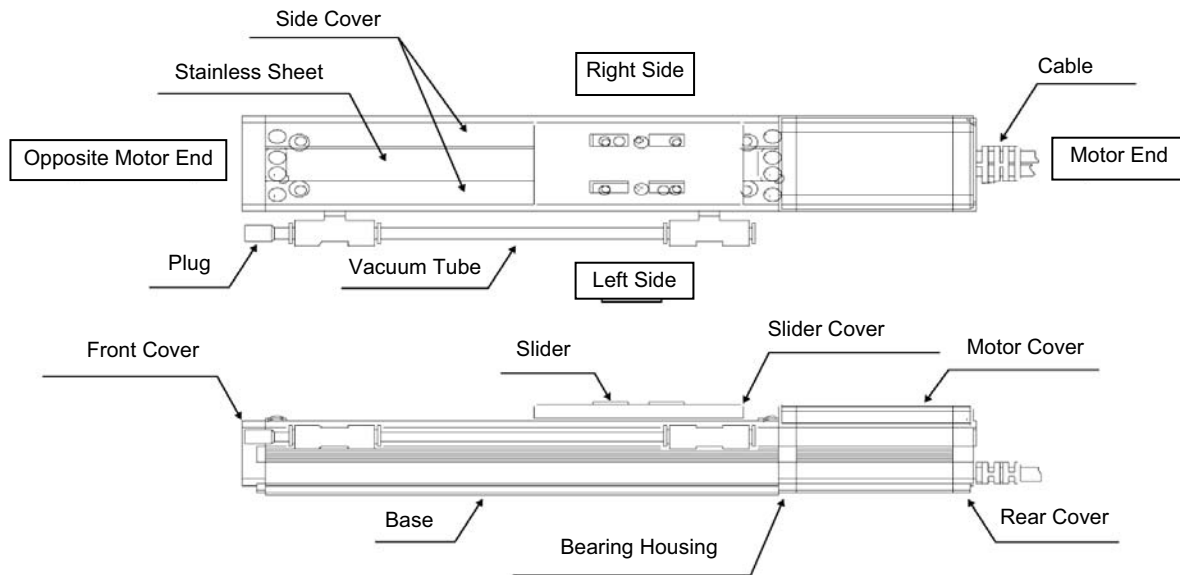

Caution: The cable directly connected to the actuator is not robot cable even when ordered with robot cable option. When designing, please be sure not to give repeated bending loads to this cable.
The robot cable is applicable only to the connecting cables.

4. Motor Straight Type (Cleanroom specification) RCS3(P)-CR

● **Coupling Type (SA8)**

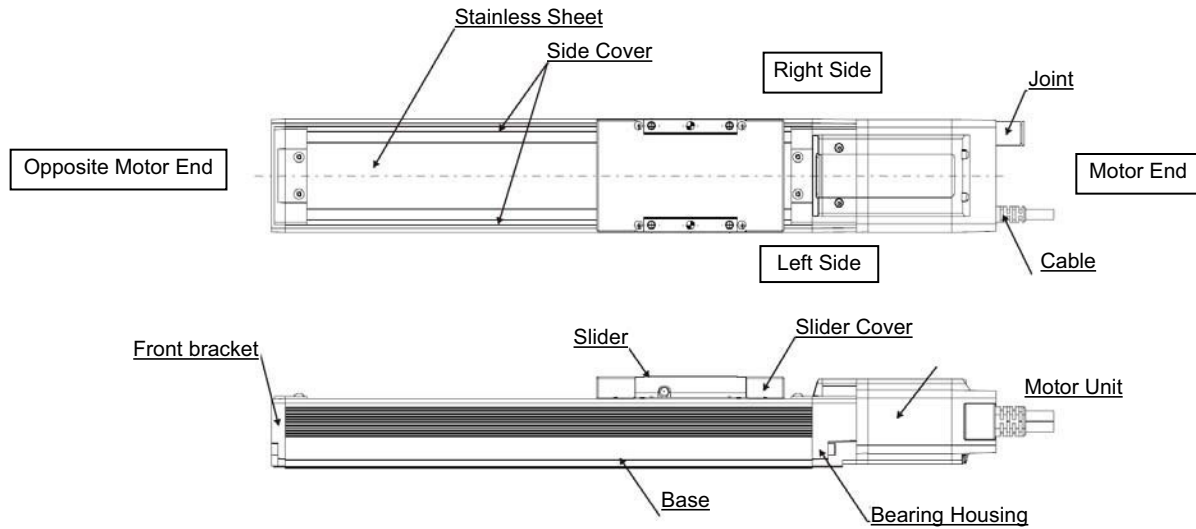

● **Coupling Type (SS8)**

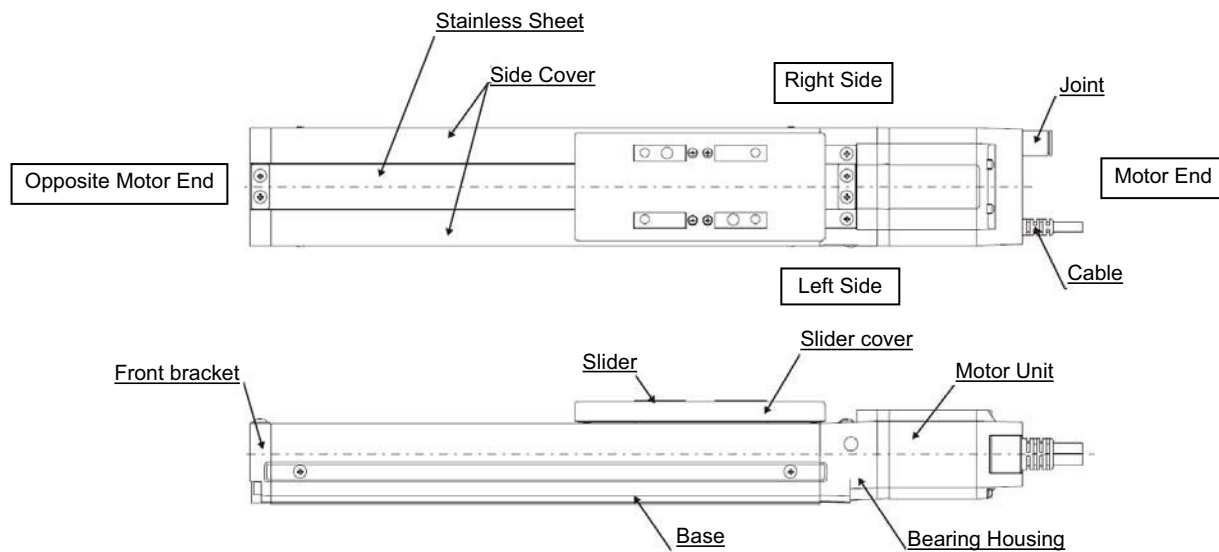

5. Motor Reversing Type RCS2

- SA4R, SA5R, SA6R, SA7R, SS7R, SS8R

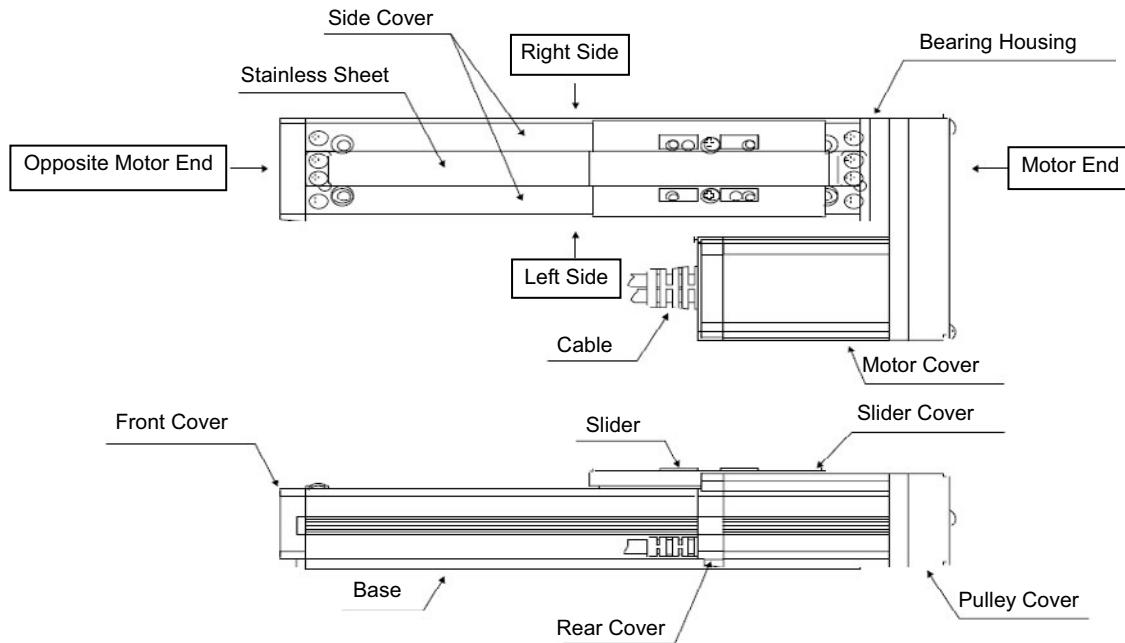

⚠ Caution: The cable directly connected to the actuator is not robot cable even when ordered with robot cable option. When designing, please be sure not to give repeated bending loads to this cable.
The robot cable is applicable only to the connecting cables.

6. Motor Reversing Type (Standard) RCS3 (P)

● SA8R

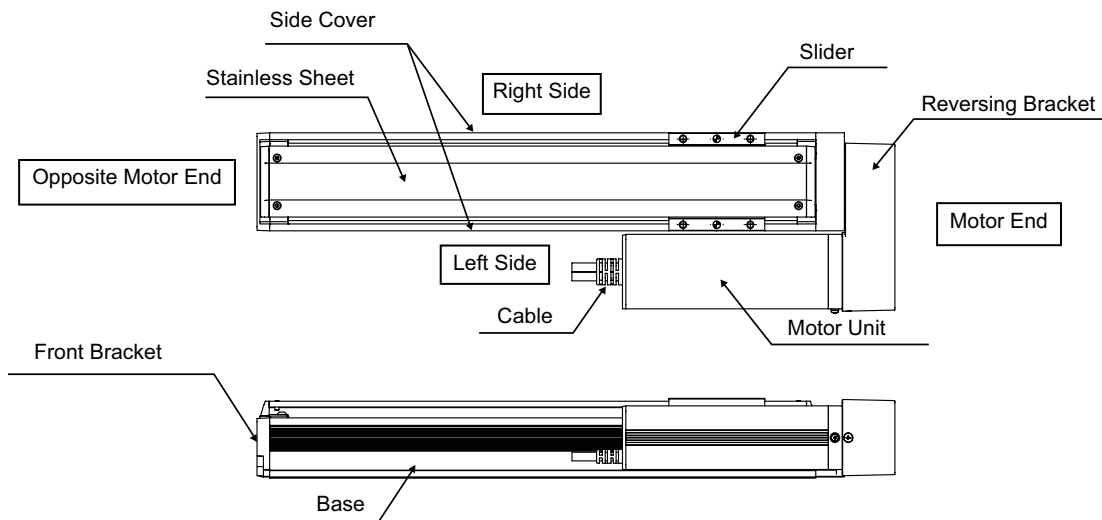

● SS8R

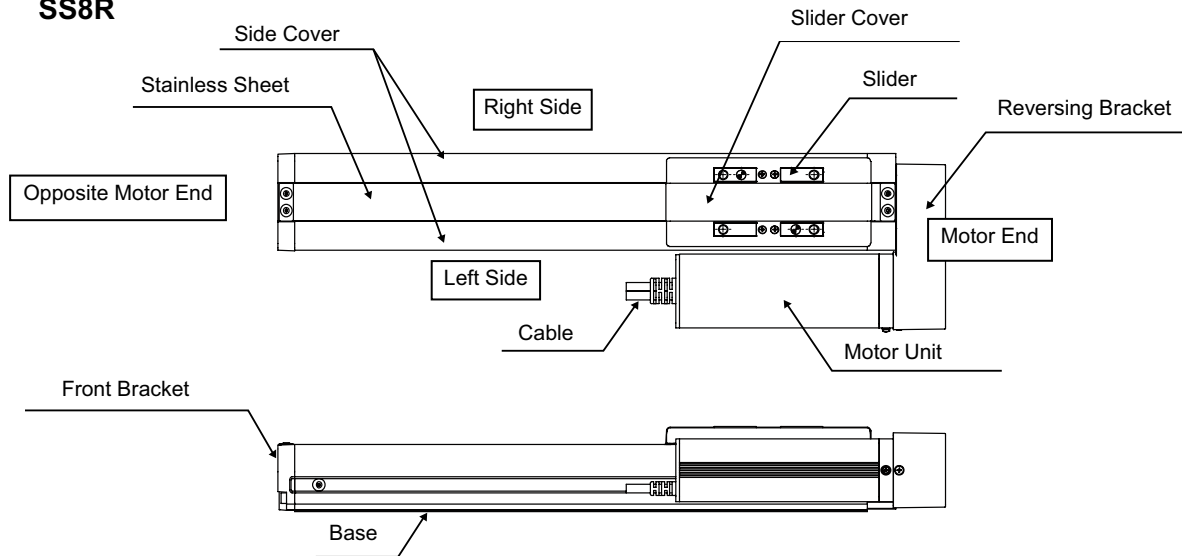

⚠ Caution: The cable directly connected to the actuator is not robot cable even when ordered with robot cable option. When designing, please be sure not to give repeated bending loads to this cable.
The robot cable is applicable only to the connecting cables.

7. Motor Reversing Type (Slider Roller Specification) RCS3 (P)

- SA8R (Option model number: SR)

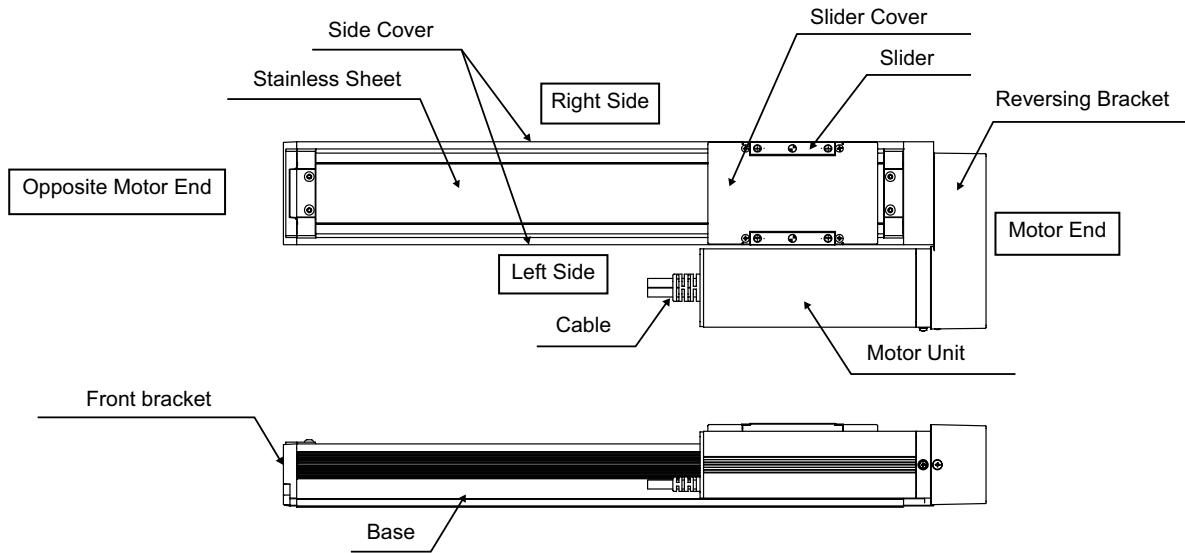

- SS8R (Option model number: SR)

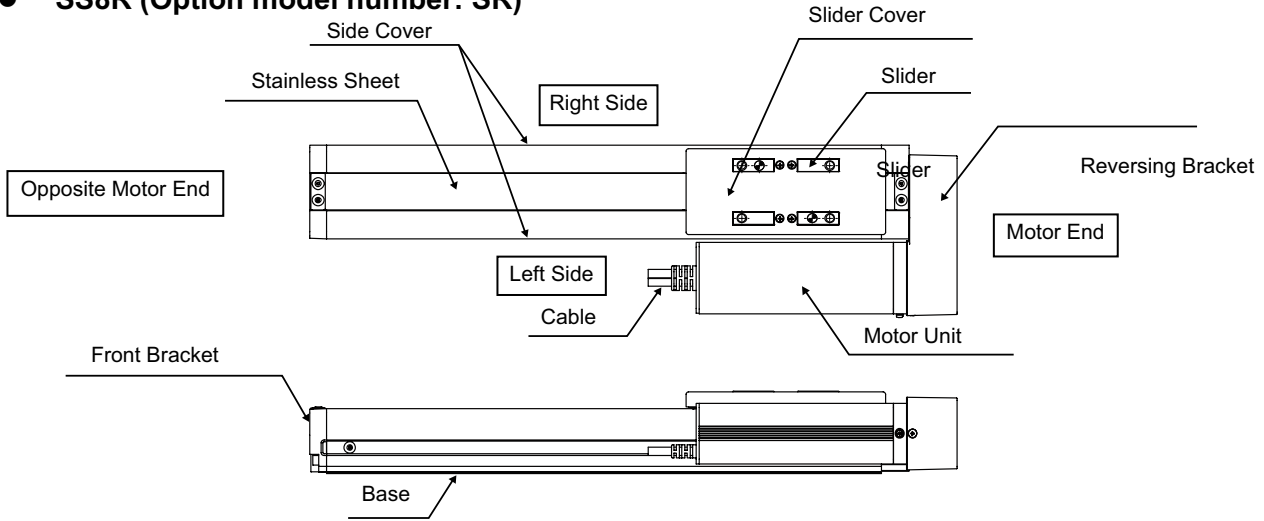

Caution: The cable directly connected to the actuator is not robot cable even when ordered with robot cable option. When designing, please be sure not to give repeated bending loads to this cable.
The robot cable is applicable only to the connecting cables.

1. Checking the Product

If based on a standard configuration, this product consists of the items listed below.

 **Caution:** Check the packed items against the packing specification. Should you find a wrong model number or any missing item, please contact your IAI dealer or IAI.

1.1 Components

No.	Name	Model	Remarks
1	Actuator	Refer to “How to Read the Model Nameplate” and “How to Read the Model Number.”	
Accessories			
2	Motor encoder cable *1		
3	Home making seals		
4	Quick Step Guide		
5	Operation Manual (CD/DVD)		
6	Safety Guide		

*1 The motor cable and encoder cable supplied with each actuator vary depending on the controller used with the actuator. [Refer to 10, “Motor/Encoder Cables.”]

1.2 Operation Manuals for Controllers Supported by This Product

(1) XSEL-J/K controllers

No.	Name	Control No.
1	Operation Manual for XSEL-J/K Controller	ME0116
2	Operation Manual for PC Software IA-101-X-MW/IA-101-X-USBMW	ME0154
3	Operation Manual for Teaching Pendant SEL-T/TD/TG	ME0183
4	Operation Manual for Teaching Pendant IA-T-X/XD	ME0160
5	Operation Manual for DeviceNet	ME0124
6	Operation Manual for CC-Link	ME0123
7	Operation Manual for PROFIBUS	ME0153
8	Operation Manual for X-SEL Ethernet	ME0140
9	Operation Manual for Multi-point I/O Board	ME0138
10	Operation Manual for Dedicated Multi-point I/O Board Terminal Block	ME0139

(2) XSEL-P/Q controllers

No.	Name	Control No.
1	Operation Manual for XSEL-P/Q Controller	ME0148
2	Operation Manual for XSEL-P/Q/PX/QX RC Gateway Function	ME0188
3	Operation Manual for PC Software IA-101-X-MW/IA-101-X-USBMW	ME0154
4	Operation Manual for Teaching Pendant SEL-T/TD/TG	ME0183
5	Operation Manual for Teaching Pendant IA-T-X/XD	ME0160
6	Operation Manual for DeviceNet	ME0124
7	Operation Manual for CC-Link	ME0123
8	Operation Manual for PROFIBUS	ME0153

(3) SSEL controllers

No.	Name	Control No.
1	Operation Manual for SSEL Controller	ME0157
2	Operation Manual for PC Software IA-101-X-MW/IA-101-X-USBMW	ME0154
3	Operation Manual for Teaching Pendant SEL-T/TD/TG	ME0183
4	Operation Manual for Teaching Pendant IA-T-X/XD	ME0160
5	Operation Manual for DeviceNet	ME0124
6	Operation Manual for CC-Link	ME0123
7	Operation Manual for PROFIBUS	ME0153

(4) SCON controllers

No.	Name	Control No.
1	Operation Manual for SCON Controller	ME0161
2	Operation Manual for PC Software RCM-101-MW/RCM-101-USB	ME0155
3	Operation Manual for Teaching Pendant CON-T/TG	ME0178
4	Operation Manual for Touch Panel Teaching Pendant CON-PT/PD/PG	ME0227
5	Operation Manual for Simple Teaching Pendant RCM-E	ME0174
6	Operation Manual for Data Setter RCM-P	ME0175
7	Operation Manual for Touch Panel Display RCM-PM-01	ME0182
8	Operation Manual for DeviceNet	ME0124
9	Operation Manual for CC-Link	ME0123
10	Operation Manual for PROFIBUS	ME0153

1.3 How to Read the Model Nameplate

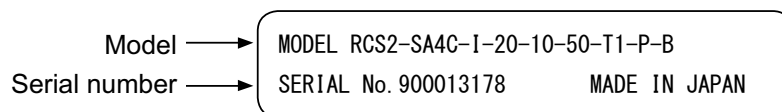

1.4 How to Read the Model Number

1.4.1 RCS2

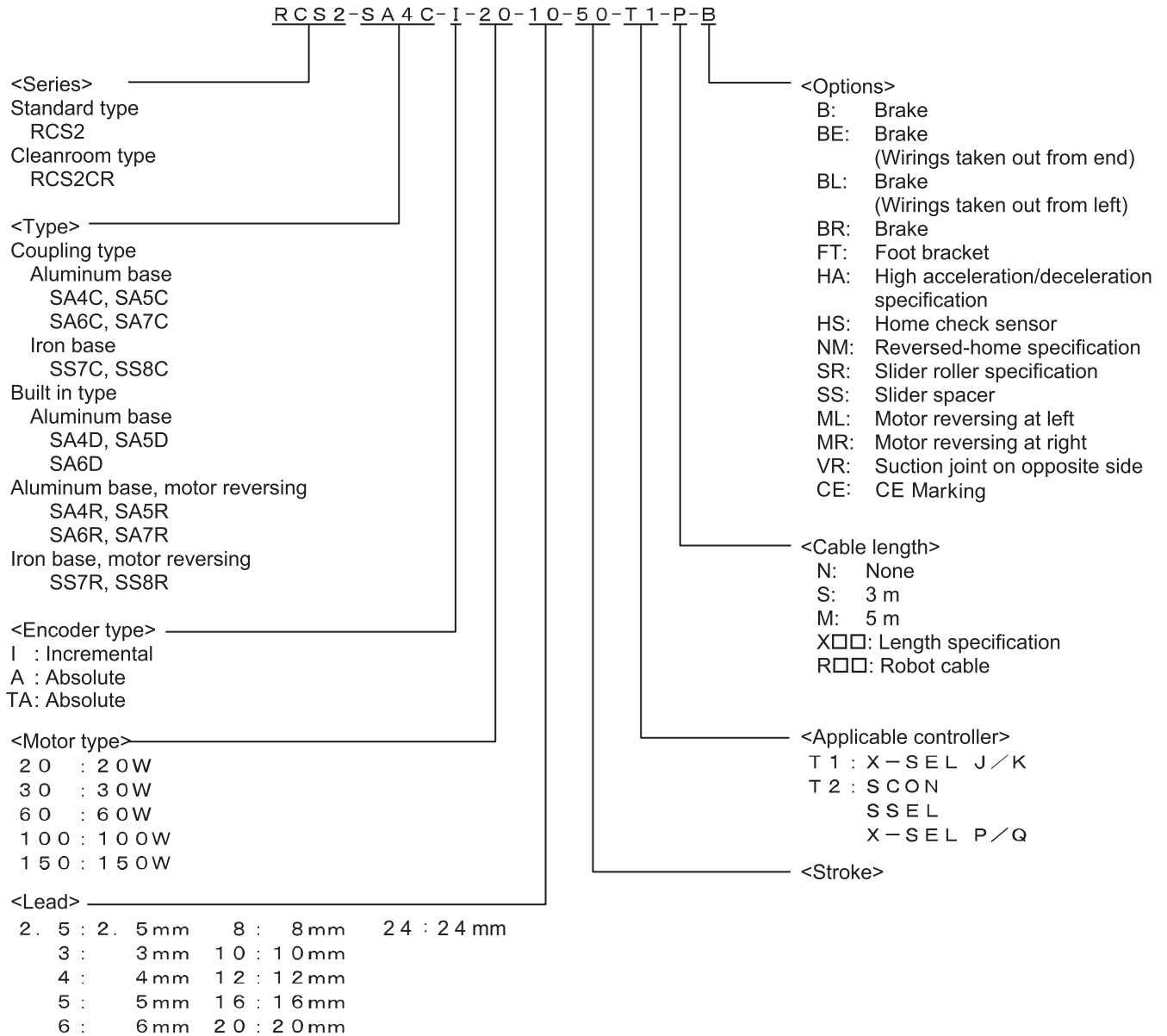

Caution: For Absolute Type, there are encoder types A and TA.

Check the model types of the actuator and the controller when the controller is one of those listed below. In the case the encoder type differs from what is indicated on the label, it may be necessary to make some changes to the parameters. Please contact your nearest IAI sales office. Using the controller that requires parameter changes will cause D67 (Motor/Encoder Structure Information) Error. However, it would not cause malfunction of the product.

[Applicable Controllers]

XSEL-J/K, XSEL-P/Q, SSEL

1.4.2 RCS3

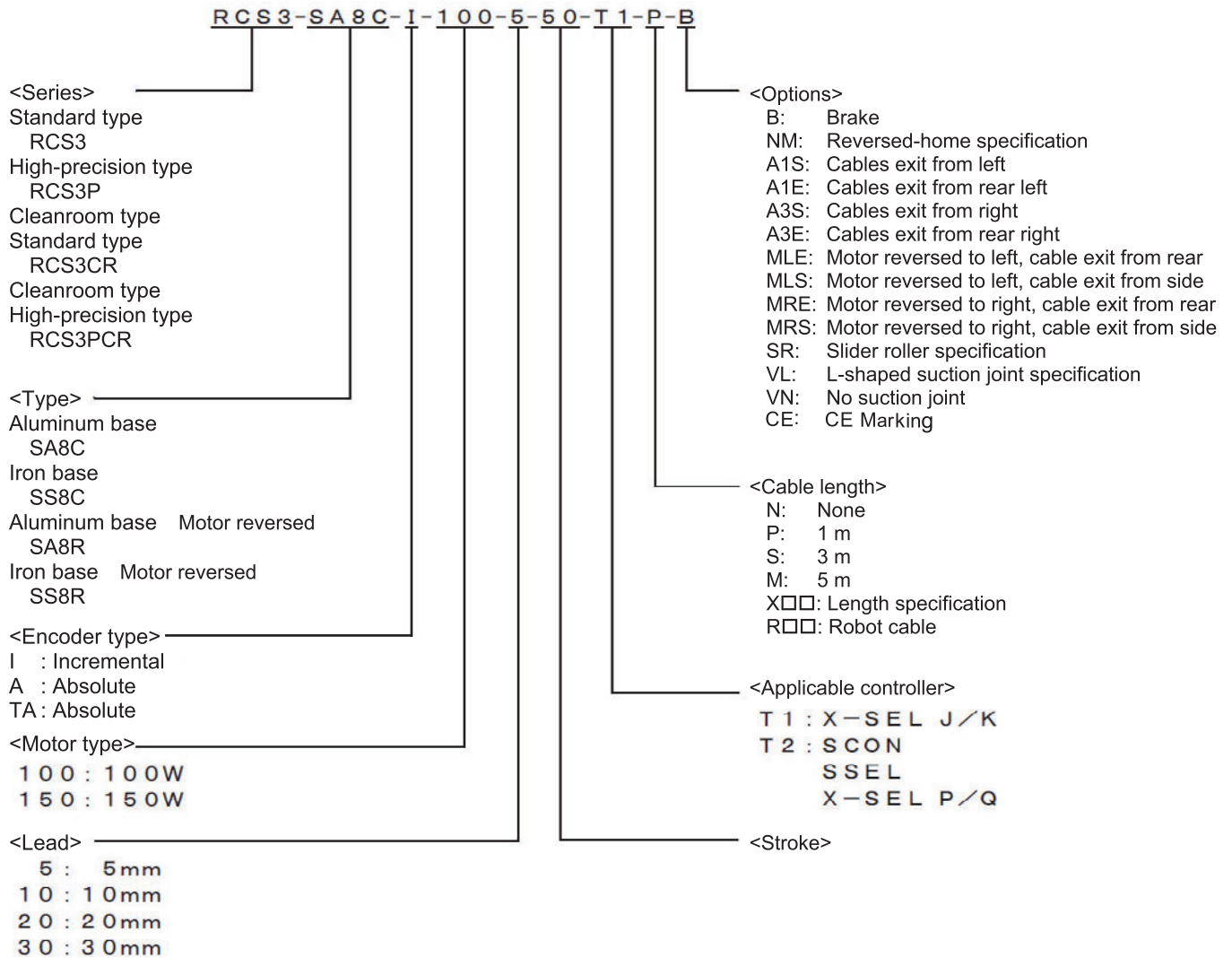

Caution: For Absolute Type, there are encoder types A and TA. Check the model types of the actuator and the controller when the controller is one of those listed below. In the case the encoder type differs from what is indicated on the label, it may be necessary to make some changes to the parameters. Please contact your nearest IAI sales office. Using the controller that requires parameter changes will cause D67 (Motor/Encoder Structure Information) Error. However, it would not cause malfunction of the product.

[Applicable Controllers]
XSEL-J/K, XSEL-P/Q, SSEL

2. Specification

(1) Maximum speed

The maximum speed of the actuator is limited to prevent resonance of the ball screw shaft and also in consideration of the restrictions on motor speed.

Observe the maximum speed limits specified below.

[RCS2 and Cleanroom specification RCS2CR]

Strokes and maximum speed limits (unit: mm/sec)

Type	Lead [mm]	Stroke [mm]																
		50	100	150	200	250	300	350	400	450	500	550	600	700	800	900	1000	
SA4	2.5	165								-	-	-	-	-	-	-	-	-
	5	330								-	-	-	-	-	-	-	-	-
	10	665								-	-	-	-	-	-	-	-	-
RCS2-SA4C	16	1060								-	-	-	-	-	-	-	-	-
SA5	3	200								190	-	-	-	-	-	-	-	-
	6	400								380	-	-	-	-	-	-	-	-
	12	800								760	-	-	-	-	-	-	-	-
SA5C	20	1300 (installed horizontally)								-	-	-	-	-	-	-	-	
		800 (installed vertically)								-	-	-	-	-	-	-	-	
SA6	3	200								190	160	135	-	-	-	-	-	
	6	400								380	320	270	-	-	-	-	-	
	12	800								760	640	540	-	-	-	-	-	
SA6C	20	1300 (installed horizontally)								1160	990	-	-	-	-	-		
		800 (installed vertically)								-	-	-	-	-	-	-		
SA7	4	200								160	120	-	-	-	-	-		
	8	400								320	240	-	-	-	-	-		
	16	800								640	480	-	-	-	-	-		
RCS2-SA7C	24	1200								960	720	-	-	-	-	-		
SS7	6	300								230	-	-	-	-	-	-		
	12	600								470	-	-	-	-	-	-		
SS8	10	500								480	380	310	265	-	-	-		
	20	1000								960	765	625	515	-	-	-		



Caution: Do not set any speed or acceleration/deceleration exceeding the rated speed or acceleration/deceleration. Doing so may result in vibration, failure or shorter life. When combining multiple axes and synchronizing their operations, the speed and acceleration/deceleration to be set should correspond to the highest speed and largest acceleration/deceleration among those of the combined axes. In particular, exercise caution because setting an acceleration/deceleration exceeding the rated acceleration/deceleration may cause the actuator to suffer creep or the coupling to slip.

[RCS3 (P)]

Strokes and maximum speed limits [unit: mm/s]

Type	Motor capacity [W]	Lead [mm]	50	100	150	200	250	300	350	400	450	500	550	600	650	700	750	800	850	900	950	1000	1050	1100		
SA8	100	5	300													260	230	200	180	170	150	135	120	110		
		10	600													530	470	410	370	340	310	270	250	230		
		20	1200													1070	940	840	750	670	610	550	500	460		
		30	1800													1610	1420	1260	1120	1010	910	830	760	690		
	150	10	600													530	470	410	370	340	310	270	250	230		
		20	1200													1070	940	840	750	670	610	550	500	460		
		30	1800													1610	1420	1260	1120	1010	910	830	760	690		
SS8	100	5	300													275	240	215	190	170	150	140	125	—	—	
		10	600													550	485	430	385	345	310	280	255	—	—	
		20	1200													1105	970	860	770	690	625	565	515	—	—	
		30	1800													1660	1460	1295	1155	1035	935	850	775	—	—	
	150	10	600													550	485	430	385	345	310	280	255	—	—	
		20	1200													1105	970	860	770	690	625	565	515	—	—	
		30	1800													1660	1460	1295	1155	1035	935	850	775	—	—	

[RCS3 (P) CR Cleanroom Specification,
RCS3 (P) Slider Part Roller Specification (The options of the type SR)]

Strokes and maximum speed limits [unit: mm/s]

Type	Motor capacity [W]	Lead [mm]	50	100	150	200	250	300	350	400	450	500	550	600	650	700	750	800	850	900	950	1000	1050	1100		
SA8	100	5	300													250	220	190	170	160	140	130	120	110		
		10	600													500	440	390	350	320	290	260	240	220		
		20	1200													1010	890	790	710	640	580	530	480	440		
		30	1800													1510	1340	1190	1070	960	870	790	720	660		
	150	10	600													500	440	390	350	320	290	260	240	220		
		20	1200													1010	890	790	710	640	580	530	480	440		
		30	1800													1510	1340	1190	1070	960	870	790	720	660		
SS8	100	5	300													275	240	215	190	170	150	140	125	—	—	
		10	600													550	485	430	385	345	310	280	255	—	—	
		20	1200													1105	970	860	770	690	625	565	515	—	—	
		30	1800													1660	1460	1295	1155	1035	935	850	775	—	—	
	150	10	600													550	485	430	385	345	310	280	255	—	—	
		20	1200													1105	970	860	770	690	625	565	515	—	—	
		30	1800													1660	1460	1295	1155	1035	935	850	775	—	—	

(2) Maximum acceleration and loading capacity

[RCS2]

Type	Motor capacity [W]	Lead [mm]	Maximum acceleration [G]		Maximum loading capacity [kg]		
SA4C	20	2.5	Horizontal	0.2	8		
			Vertical	High-acceleration/deceleration mode: 0.2		4.5	
		5	Horizontal	0.3	6		
			Vertical	High-acceleration/deceleration mode: 1.0		2.5	
		10	Horizontal	0.3	4		
			Vertical	High-acceleration/deceleration mode: 1.0		1	
		16	Horizontal	0.3	2.5		
			Vertical	High-acceleration/deceleration mode: 1.0		0.6	
SA5C	20	3	Horizontal	0.2	12		
			Vertical	High-acceleration/deceleration mode: 0.2		4	
		6	Horizontal	0.3	8		
			Vertical	High-acceleration/deceleration mode: 0.8		2	
		12	Horizontal	0.3	4		
			Vertical	High-acceleration/deceleration mode: 0.8		1	
SA6C	30	3	Horizontal	0.2	18		
			Vertical	High-acceleration/deceleration mode: 0.2		6	
		6	Horizontal	0.3	12		
			Vertical	High-acceleration/deceleration mode: 1.0		3	
		12	Horizontal	0.3	6		
			Vertical	High-acceleration/deceleration mode: 1.0		1.5	
SA7C	60	4	Horizontal	0.2	40		
			Vertical	High-acceleration/deceleration mode: 0.2		12	
		8	Horizontal	0.3	25		
			Vertical	High-acceleration/deceleration mode: 1.0		6	
		16	Horizontal	0.3	12		
			Vertical	High-acceleration/deceleration mode: 1.0		3	
		24	Horizontal	0.3	8.0		
			Vertical	High-acceleration/deceleration mode: 1.0		6.5	
SS7C	60	6	Horizontal	0.3	30		
			Vertical			8	
		12	Horizontal	0.3	15		
			Vertical			4	
		SS8C	100	10	Horizontal	0.3	40
					Vertical		
20	Horizontal			0.3	20		
	Vertical					4	
150	10	Horizontal	0.3	60			
		Vertical			12		
	20	Horizontal	0.3	30			
		Vertical			6		

Type	Motor capacity [W]	Lead [mm]	Maximum acceleration [G]		Maximum loading capacity [kg]
SA4D	20	2.5	Horizontal	0.2	8
			Vertical		4.5
		5	Horizontal	0.3	6
			Vertical		2.5
		10	Horizontal	0.3	4
			Vertical		1
SA5D	20	3	Horizontal	0.2	12
			Vertical		4
		6	Horizontal	0.3	8
			Vertical		2
		12	Horizontal	0.3	4
			Vertical		1
SA6D	30	3	Horizontal	0.2	18
			Vertical		6
		6	Horizontal	0.3	12
			Vertical		3
		12	Horizontal	0.3	6
			Vertical		1.5
SA4R	20	2.5	Horizontal	0.2	8
			Vertical		4.5
		5	Horizontal	0.3	6
			Vertical		2.5
		10	Horizontal	0.3	4
			Vertical		1
SA5R	20	3	Horizontal	0.2	12
			Vertical		4
		6	Horizontal	0.3	8
			Vertical		2
		12	Horizontal	0.3	4
			Vertical		1
SA6R	30	3	Horizontal	0.2	18
			Vertical		6
		6	Horizontal	0.3	12
			Vertical		3
		12	Horizontal	0.3	6
			Vertical		1.5
SA7R	60	4	Horizontal	0.2	40
			Vertical		12
		8	Horizontal	0.3	26
			Vertical		6
		16	Horizontal	0.3	12
			Vertical		3

Type	Motor capacity [W]	Lead [mm]	Maximum acceleration [G]		Maximum loading capacity [kg]
SS7R	60	6	Horizontal	0.3	30
			Vertical		8
		12	Horizontal	0.3	15
			Vertical		4
SS8R	100	10	Horizontal	0.3	40
			Vertical		8
		20	Horizontal	0.3	20
			Vertical		4
	150	10	Horizontal	0.3	60
			Vertical		12
		20	Horizontal	0.3	30
			Vertical		6

[Cleanroom specification RCS2CR]

Type	Motor capacity [W]	Lead [mm]	Maximum acceleration [G]		Maximum loading capacity [kg]
			Horizontal	Vertical	
SA4C	20	2.5	Horizontal	0.2	8
			Vertical		4.5
		5	Horizontal	0.3	6
			Vertical		2.5
		10	Horizontal	0.3	4
			Vertical		1
SA5C	20	3	Horizontal	0.2	12
			Vertical		4
		6	Horizontal	0.3	8
			Vertical		2
		12	Horizontal	0.3	4
			Vertical		1
SA6C	30	3	Horizontal	0.2	18
			Vertical		6
		6	Horizontal	0.3	12
			Vertical		3
		12	Horizontal	0.3	6
			Vertical		1.5
SA7C	60	4	Horizontal	0.2	40
			Vertical		12
		8	Horizontal	0.3	25
			Vertical		6
		16	Horizontal	0.3	12
			Vertical		3
SS7C	60	6	Horizontal	0.3	30
			Vertical		8
		12	Horizontal	0.3	15
			Vertical		4
SS8C	100	10	Horizontal	0.3	40
			Vertical		8
		20	Horizontal	0.3	20
			Vertical		4
	150	10	Horizontal	0.3	60
			Vertical		12
20	150	Horizontal	0.3	30	
		Vertical		6	

Type	Motor capacity [W]	Lead [mm]	Maximum acceleration [G]		Maximum loading capacity [kg]
SA5D	20	3	Horizontal	0.2	12
			Vertical		4
		6	Horizontal	0.3	8
			Vertical		2
		12	Horizontal	0.3	4
			Vertical		1
SA6D	30	3	Horizontal	0.2	18
			Vertical		6
		6	Horizontal	0.3	12
			Vertical		3
		12	Horizontal	0.3	6
			Vertical		1.5

[RCS3(P) Cleanroom specification RCS3(P)CR]

Type	Motor capacity [W]	Lead [mm]	Installation position	Rated acceleration [G]	Loading capacity by acceleration [kg]				
					0.2G	0.3G	0.5G	0.7G	1.0G
SA8	100	5	Horizontal	0.2	80	65	-	-	-
			Vertical	0.2	16	12	-	-	-
		10	Horizontal	0.3	40	40	20	-	-
			Vertical	0.2	8	8	4	-	-
		20	Horizontal	0.3	20	20	10	5	-
			Vertical	0.2	4	4	2	1.5	-
	30	Horizontal	0.3	8	8	6	4	1	
		Vertical	0.2	2	2	1.5	1	-	
	150	10	Horizontal	0.3	60	60	30	-	-
			Vertical	0.2	12	12	6	-	-
		20	Horizontal	0.3	30	30	15	7.5	-
			Vertical	0.2	6	6	3	2	-
		30	Horizontal	0.3	12	12	10	6	2
			Vertical	0.2	3	3	2	1.5	-
SS8	100	5	Horizontal	0.2	80	65	-	-	-
			Vertical	0.2	16	12	-	-	-
		10	Horizontal	0.3	40	40	20	-	-
			Vertical	0.2	8	8	4	-	-
		20	Horizontal	0.3	20	20	10	5	-
			Vertical	0.2	4	4	2	1.5	-
	30	Horizontal	0.3	8	8	6	4	1	
		Vertical	0.2	2	2	1.5	1	-	
	150	10	Horizontal	0.3	60	60	30	-	-
			Vertical	0.2	12	12	6	-	-
		20	Horizontal	0.3	30	30	15	7.5	-
			Vertical	0.2	6	6	3	2	-
		30	Horizontal	0.3	12	12	10	6	2
			Vertical	0.2	3	3	2	1.5	-



- Caution: 1. The figures of loading capacity by acceleration other than those at the rated acceleration of 0.3 G are reference values and not guaranteed. Use these values only as a reference.
 2. Even when the acceleration is less than the rated acceleration, the loading capacity will not exceed the loading capacity at the rated acceleration.

(3) Rated Thrust

[RCS2 Cleanroom specification RCS2CR]

Type	Motor capacity [W]	Lead [mm]	Rated thrust [N]
SA4	20	2.5	78.4
		5	39.2
		10	19.6
RCS2-SA4C		16	12.25
SA5	20	3	65.7
		6	33.3
		12	16.7
RCS2-SA5C		20	10.7
SA6	30	3	96.8
		6	48.4
		12	24.2
RCS2-SA6C		20	15.8
SA7	60	4	255.0
		8	127.5
		16	63.8
RCS2-SA7C		24	42.4
SS7	60	6	170.0
		12	85.0
SS8	100	10	169.0
		20	84.9
	150	10	256.0
		20	128.0

[RCS3/RCS3P Cleanroom specification RCS3CR/RCS3PCR]

Type	Motor capacity [W]	Lead [mm]	Rated thrust [N]
SA8	100	5	339.7
		10	169.8
		20	84.9
		30	56.6
	150	10	255.3
		20	127.6
		30	85.1
SS8	100	5	339.7
		10	169.8
		20	84.9
		30	56.6
	150	10	255.3
		20	127.6
		30	85.1

(4) Driving method

[RCS2 Cleanroom specification RCS2CR]

Type	Motor capacity [W]	Lead	Encoder pulses ^{*1}	Driving method	
SA4	20	2.5	16384	Ball screw Ø8 mm	Rolled, C10
		5			
		10			
RCS2-SA4C		16			
SA5	20	3		Ball screw Ø10 mm	Rolled, C10
		6			
		12			
SA5C		20			
SA6	30	3		Ball screw Ø10 mm	Rolled, C10
		6			
		12			
SA5C		20			
SA7	60	4		Ball screw Ø12 mm	Rolled, C10
		8			
		16			
RCS2-SA7C		24			
SS7	60	6	Ball screw Ø10 mm	Rolled, C10	
		12			
SS8	100	10	Ball screw Ø16 mm	Rolled, C10	
		20			
	150	10			
		20			

*1. Number of pulses input to the controller.

[RCS3 (P) Cleanroom specification RCS3 (P) CR]

Type	Motor capacity [W]	Lead	Encoder pulses ^{*1}	Driving method	
SA8	100	5	16384	Ball screw Ø16 mm	Rolled, C10 [Rolled, C5 or equivalent]
		10			
		20			
		30			
SA8	150	10		Ball screw Ø16 mm	Rolled, C10 [Rolled, C5 or equivalent]
		20			
		30			
SS8	100	5		Ball screw Ø16 mm	Rolled, C10 [Rolled, C5 or equivalent]
		10			
		20			
		30			
SS8	150	10	Ball screw Ø16 mm	Rolled, C10 [Rolled, C5 or equivalent]	
		20			
		30			

*1. Number of pulses input to the controller.

(5) Cleanliness class of clean room type RCP2CR

Item	Specification
Cleanliness class	Class 10 (1 μm) when air is suctioned from the suction joint at an appropriate rate of suction

(6) Common specifications

[RCS2, Cleanroom specification RCS2CR]

Item	Specification
Positioning repeatability	± 0.02 mm
Lost motion	0.1 mm or less

[RCS3(P), Cleanroom specification RCS3(P)CR]

Item	Specification
Positioning repeatability	± 0.02 mm [± 0.01 mm]
Lost motion	0.1 mm or less [0.05 mm or less]

The values in [] apply to the high-precision type.

(7) Load on the Actuator

Do not exceed the load shown in the load specification column. Please make note of the slider moment, allowable overhang length and the load weight.

[RCS2, Cleanroom specification RCS2CR]

Dynamic allowable load moments

Model	Ma	Mb	Mc
SA4	2.7 N·m (0.27 kgf·m)	3.9 N·m (0.4 kgf·m)	6.8 N·m (0.7 kgf·m)
SA5	4.9 N·m (0.5 kgf·m)	6.8 N·m (0.7 kgf·m)	11.7 N·m (1.2 kgf·m)
SA6	8.9 N·m (0.9 kgf·m)	12.7 N·m (1.3 kgf·m)	18.6 N·m (1.9 kgf·m)
SA7	13.9 N·m (1.41 kgf·m)	19.9 N·m (2 kgf·m)	38.3 N·m (3.9 kgf·m)
SS7	14.7 N·m (1.49 kgf·m)	14.7 N·m (1.49 kgf·m)	33.3 N·m (3.39 kgf·m)
SS8	36.3 N·m (3.7 kgf·m)	36.3 N·m (3.7 kgf·m)	77.4 N·m (7.89 kgf·m)

Allowable overhang lengths

Model	Ma direction	Mb direction	Mc direction
SA4	120 mm or less	120 mm or less	120 mm or less
SA5	150 mm or less	150 mm or less	150 mm or less
SA6	220 mm or less	220 mm or less	220 mm or less
SA7	230 mm or less	230 mm or less	230 mm or less
SS7	300 mm or less	300 mm or less	300 mm or less
SS8	450 mm or less	450 mm or less	450 mm or less

[RCS3(P), Cleanroom specification RCS3 (P) CR]

Dynamic allowable load moments

Model	Motor capacity [W]	Ma	Mb	Mc
SA8	100	23.1 N·m (2.35 kgf·m)	32.9 N·m (3.35 kgf·m)	54.1 N·m (5.52 kgf·m)
	150	23.1 N·m (2.35 kgf·m)	32.9 N·m (3.35 kgf·m)	54.1 N·m (5.52 kgf·m)
SS8	100	36.3 N·m (3.7 kgf·m)	36.3 N·m (3.7 kgf·m)	77.4 N·m (7.9 kgf·m)
	150	36.3 N·m (3.7 kgf·m)	36.3 N·m (3.7 kgf·m)	77.4 N·m (7.9 kgf·m)

Allowable overhang lengths

Model	Motor capacity [W]	Ma direction	Mb direction	Mc direction
SA8	100	390 mm	390 mm	390 mm
	150	390 mm	390 mm	390 mm
SS8	100	450 mm	450 mm	450 mm
	150	450 mm	450 mm	450 mm

- The allowable overhang lengths are based on a configuration where the center of gravity of the load mounted on the actuator corresponds to the center of the overhang length.

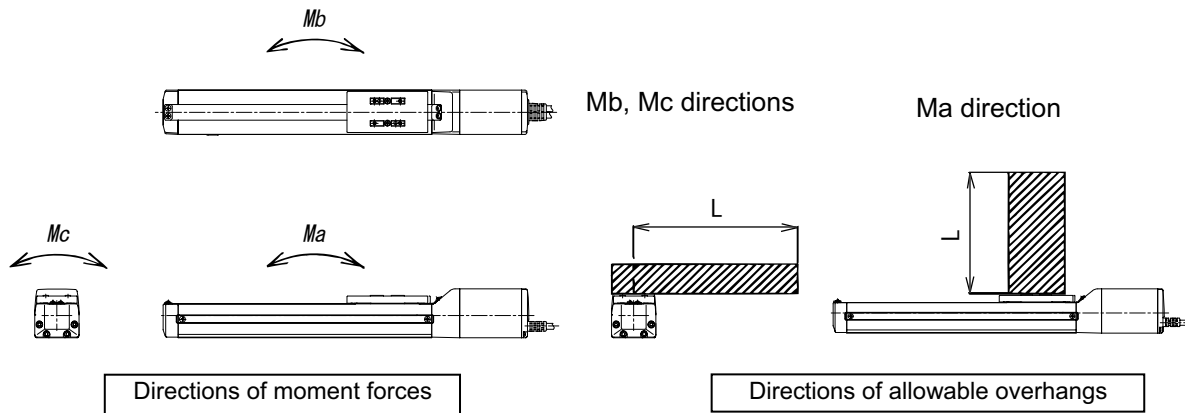

(Note) To calculate the moments in M_a and M_c directions, offset the reference position by L mm from the top surface of the slider, as shown in the figure below.

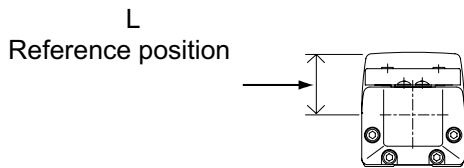

		l
RCS2 RCS2CR	SA4、SS4	31.2mm
	SA5、SS5	39.0mm
	SA6、SS6	40.0mm
	SA7	43.0mm
	SS7	36.0mm
RCS3 (P) RCS3 (P) CR	SS8	48.0mm
	SA8	44.0mm

If an actuator is used as the Y-axis in a cantilever system based on X-Y combination, its base deforms easily. Accordingly, keep the M_a and M_c moments to no more than one-half their respective ratings. (See the figure below.)

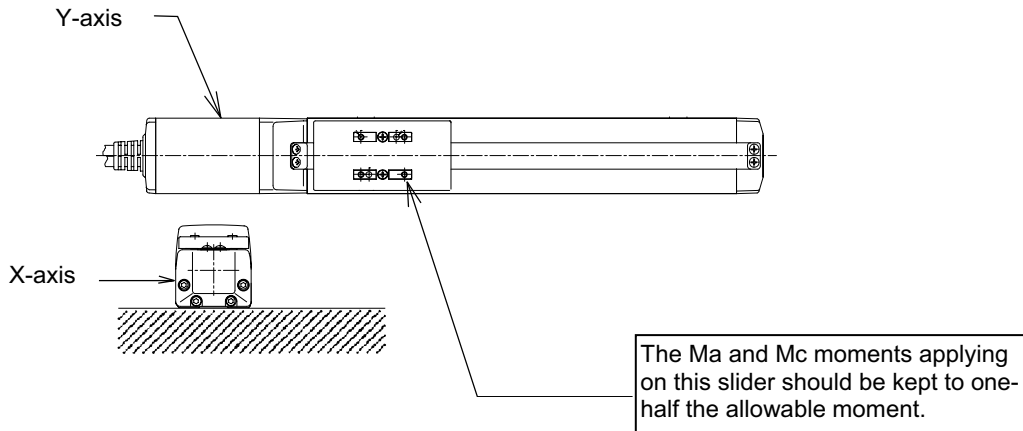

Caution: Allowing the slider to receive an excessive load moment will shorten the service life of the guides. If the allowable overhang length is exceeded, vibration may generate or the service life of the guides may be reduced.

(7) Actuator Precision

[1] Actuator installation surface

Parallelism of the actuator installation surface (bottom surface of the base) and load installation surface (top surface) at an arbitrary stroke position: 0.1 mm or less

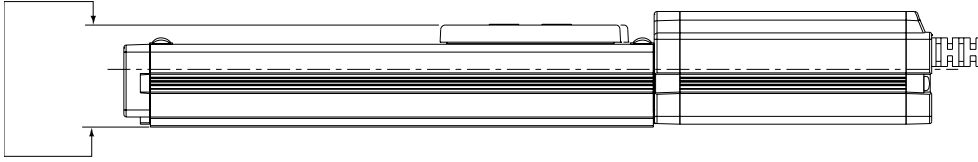

[2] Traveling parallelism when the actuator is installed (affixed on a flat, smooth surface^{*1}): 0.05 mm/m or less

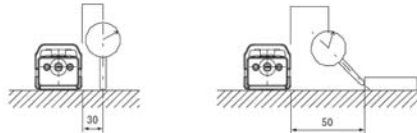

Condition: The above values have been measured at 20°C. *1 Parallelism: 0.05 mm/m or less



3. Life

One factor that affects the traveling life of an actuator is “Rated Load.”

There are two types of rated loads: “Static Rated Load” and “Dynamic Rated Load.”

- “Static Rated Load”: Load applied while the actuator is stopped, as a result of which minor pressure marks are left on the contact surface
- “Dynamic Rated Load”: Load under which the actuator can travel for a specified distance and still meet a specified probability of survival defined by no damage to its guide.

Manufacturers of guides indicate the life of each guide by a dynamic rated load based on a probability of survival (no damage to the guide) of 90% after 50 km of traveling.

With industrial equipment, however, dynamic rated loads must be defined based on longer traveling distance of 5,000 km to 10,000 km given the moving speed, operating ratios and other operating conditions of these equipment.

Also note that guides are generally designed with a sufficient life against radial loads. Moment loads that are applied at positions away from the guide center are most damaging to guides.

The traveling life is calculated by assuming that the actuator travels 5,000 km or 10,000 km while receiving the allowable load moment, based on a load coefficient of 1.2.

[For the allowable dynamic load moment, refer to 2, “Specifications.”]

- Models with traveling life of 5,000 km
RCS2- SA4C, SA5C, SA6C, SA7C, SA4D, SA5D, SA6D, SA4R, SA5R, SA6R, SA7
- Models with traveling life of 10,000 km
RCS2- SS7C, SS8C, SS7R, SS8R
RCS2CR- SS7C, SS8C
RCS3/RCS3P- SA8C, SS8C, SA8R, SS8R
RCS3CR/RCS3PCR- SA8C, SS8C

The formula for calculating the allowable dynamic load moment corresponding to a traveling life of 5,000 km is shown below. If the traveling life is 10,000 km, replace “5000 km” in the formula with “10000 km”:

$$C_{IA} = \frac{M_{50}}{f_w} \times \left(\frac{50\text{km}}{5000\text{km}} \right)^{\frac{1}{3}}$$

C_{IA} : Allowable dynamic load moment
 f_w : Load coefficient (= 1.2)
 M_{50} : Dynamic rated moment based on 50 km of traveling and probability of survival of 50%

The life at the actual moment applied is calculated by the formula below:

$$L = \left(\frac{C_{IA}}{P} \right)^3 \times 5000\text{km}$$

L : Traveling life (probability of survival: 90%)
 C_{IA} : Allowable dynamic moment
 P : Actual moment applied

4. Installation and Storage/Preservation Environment

4.1 Installation Environment

The actuator should be set up in an environment, which meets the following criteria:

- Avoid direct sunlight.
- Avoid radiant heat from strong heat sources such as a furnace.
- Surrounding air temperature should be 0 ~ 40°C.
- The humidity should be less than 85% and there should be no condensation.
- Avoid exposure to corrosive or combustible gases.
- The area should have very little dust and be suitable for normal assembly operations.
- Avoid exposure to oil mist or fluids used in cutting.
- The unit should not be subject to impacts or vibrations.
- Avoid extreme electromagnetic waves, ultraviolet rays and radiation.
- This product is not intended to be used in a chemical environment.

In general, the environment should be one in which an operator can work without protective gear.

Work space needed for maintenance/inspection

[Motor straight type]

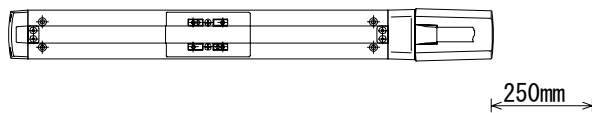

[Motor reversing type]

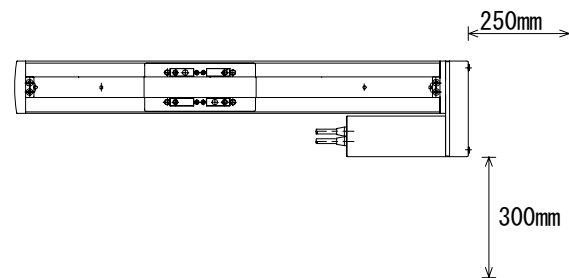

4.2 Storage/Preservation Environment

The storage/preservation environment should be similar to the installation environment. In addition, you must take precautions against condensation if the unit is to be stored for a long period of time. Unless there are special instructions, we do not include moisture absorption agents when shipping the unit. If you are storing the unit where condensation might occur, then you must treat the entire package or treat the unit itself after it is unpacked to prevent condensation. The unit can withstand up to 60°C during a short storage/preservation interval but only up to 50°C if the storage/preservation period is longer than one month.

5. Installation

The method to install your actuator in a mechanical system is explained.

5.1 Installation

Install the actuator as explained below, as a rule.

Pay attention to these items when installing the actuator (except for custom-order models).

○: Installable Δ: Daily inspection is required x: Not installable

Type	Horizontal installation	Vertical installation	Sideway installation	Ceiling mount installation
SA4	○	○	○	Δ
SA5	○	○	Δ	Δ
SA6	○	○	Δ	Δ
SA7, SS7	○	○	Δ	Δ
SS8	○	○	Δ	Δ
SA8 (with stainless steel sheet)	○	○	Δ	Δ
SA8 (with screw cover)	○	○	○	○

Installation postures

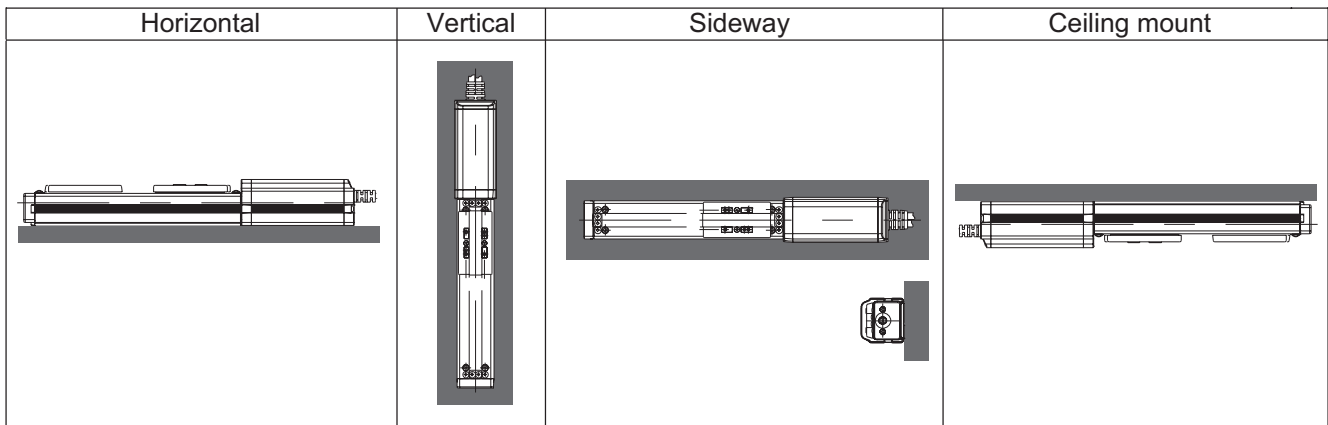

- ⚠ Caution: 1. When the unit is installed vertically oriented, attempt to put the motor up unless there is a special reason. Putting the motor on the lower side would not cause a problem in an ordinary operation. However, it may rarely cause a problem, when it is not operated for a long period, depending on the surrounding environment (especially high temperature), caused by the grease being separated and the base oil flowing into the motor unit.
2. The clean room types listed below cannot be guaranteed to meet Cleanliness Class 10 if they are installed in the vertical orientation, the horizontally wall mounted orientation or in the ceiling mounted orientation since they do not possess a structure to grip the stainless steel sheet from the side cover.
Please contact us if it is necessary to install the following models in an orientation other than the horizontal orientation.
Actuator Model : RCS2CR-SA5D, RCS2CR-SA6D
3. The actuator with the stainless sheet can be installed sideways or ceiling mount, but it must be checked daily.
If the actuator is installed sideways or ceiling mount, the stainless sheet may be slacked or displaced. If the actuator is used continuously while the stainless sheet is slacked or displaced, the stainless sheet may break or other problems may occur. Check the actuator daily and if the stainless sheet is found slacked or displaced, make installation adjustment of the stainless sheet. [Refer to 11,8 "Replacing/Adjusting the Stainless Sheet."]
4. There is a concern that the screw cover may get warped and interfere with a work piece for RCS3(P)-SA8C and SA8R if they are installed in horizontally oriented wall mount or in ceiling mount.
If the stroke exceeds 400mm, put a work piece that is to be attached away from the slider seat surface when attaching it.

Stroke	Distance A
400mm or more less than 800mm	5mm or more
800mm or more less than 1100mm	7mm or more

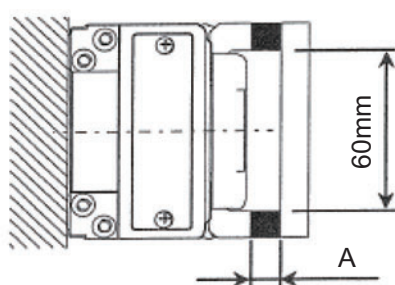

[Sideway installation]

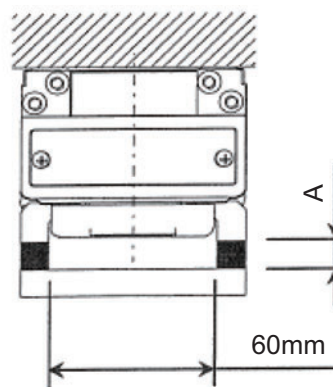

[Ceiling mount installation]

5.2 Notes on Installation

The stainless sheet is designed very thin (thickness: approx. 0.1 mm) in order to ensure flexibility. Therefore, the stainless sheet is easily dented or scratched. Once dented or scratched, the stainless sheet may break during use.

When installing the stainless sheet, pay attention to the following points:

1. Do not press the sheet directly with hands

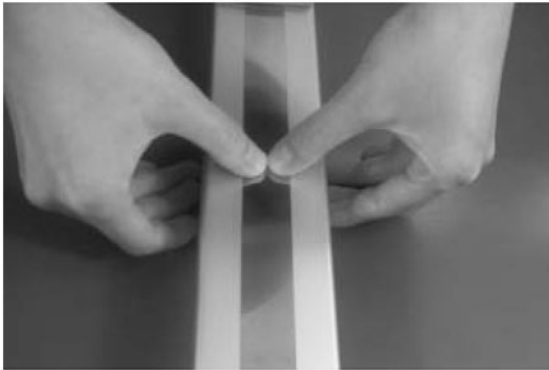

2. Protect the sheet from dents by paying attention not to drop tools and work parts onto the sheet.

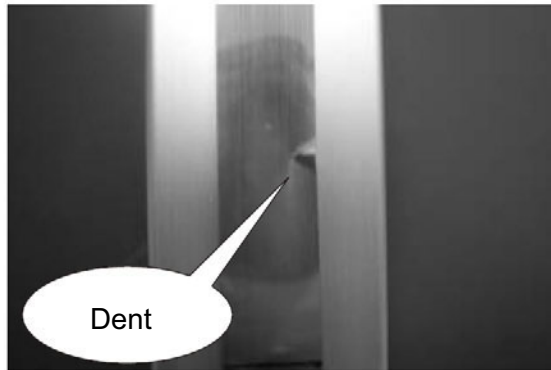

3. Do not allow powder dust or iron powder to generate around the stainless sheet.

If generation of powder dust/iron powder cannot be fully prevented, wipe the stainless sheet after the operation to remove all particles attached to the sheet.

If the actuator is operated with the stainless sheet carrying foreign particles, the particles may enter the slider and damage the sheet or cause the sheet to deform, lift or present other problems.

The stainless sheet is held in place by means of magnets. If surrounding air contains iron powder or other magnetic substances, they may attach to the magnets and cause problems. Pay attention to the surrounding environment and take appropriate measures, if necessary.

5.3 Installing the Actuator

The surface on which to install the actuator must be a machined surface or other flat surface having corresponding precision.

The side and bottom faces of the actuator base have been adjusted for parallelism with the guide. If traveling precision is required, install the actuator using these surfaces as reference. Take note that the applicable installation method varies depending on the type.

5.3.1 Using the Tapped Holes at Back of the Base

[RCS2 (CR)]

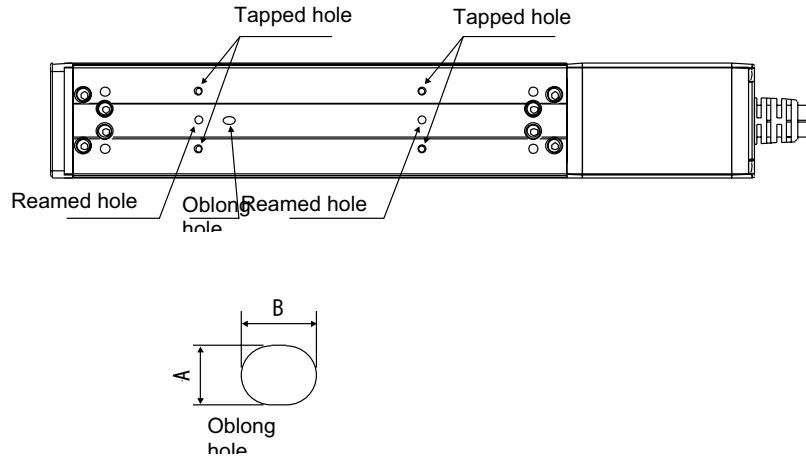

Tapped holes are provided on the back of the base for mounting the actuator. Install the actuator using these tapped holes. The sizes and effective depths of tapped holes are listed below. Be careful not to let the ends of bolts project from the holes. If necessary, use the additional reamed holes that are provided for positioning purpose.

(Two reamed holes are provided, one on the motor side and the other on the counter-motor side. One oblong hole is provided on the counter-motor side.)

Type	Tap size	Maximum screw depth	Minimum length of screw engagement	Reamed hole	Oblong hole
SA4C, D, R	M3	5 mm	3 mm	∅3H7, depth 5 mm or less	A: 3H7, B: 4, depth 5 mm or less
SA5C, D, R	M4	7 mm	4 mm	∅4H7, depth 5 mm or less	A: 4H7, B: 5, depth 5 mm or less
SA6C, R	M5	8 mm	5 mm	∅4H7, depth 5 mm or less	A: 4H7, B: 5, depth 5 mm or less
SA6D	M5	8 mm	5 mm	∅4H7, depth 5 mm or less	A: 4H7, B: 5, depth 5 mm or less
SA7C, R	M5	9 mm	5 mm	-	-
SS7C, R	M5	8 mm	5 mm	-	-
SS8C, R	M8	10 mm	8 mm	-	-



Caution: When using an aluminum-based actuator

If the length of engagement of the screw to be attached into the tapped hole is 5/8 or smaller than the maximum screw depth of the tapped hole, reduce the torque to 70 to 80% of the specified torque before tightening the screws.

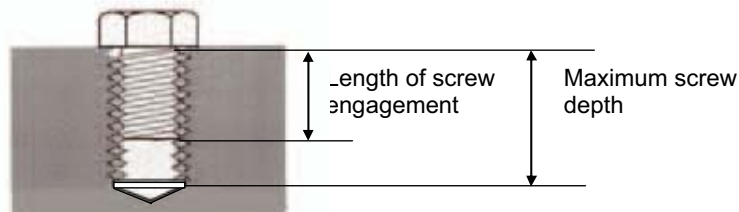

[RCS3(P) (CR)]

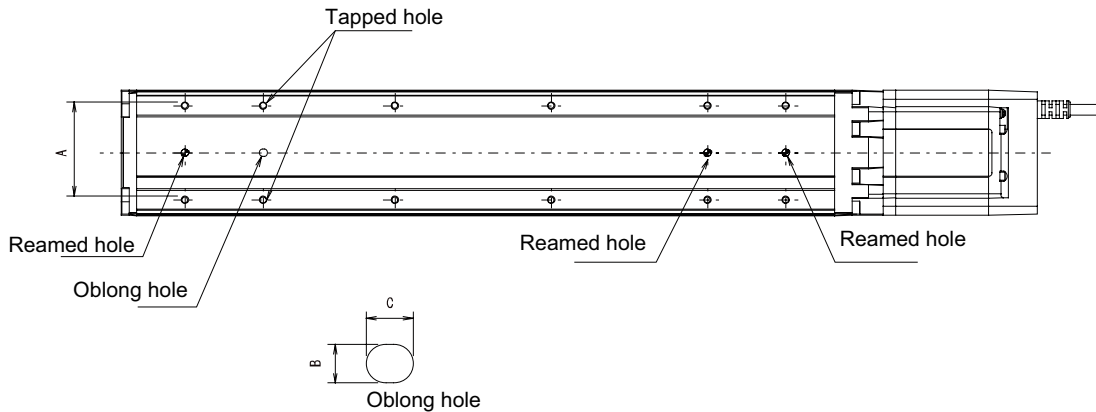

Tapped holes are provided on the back of the base for mounting the actuator. Install the actuator using these tapped holes. The sizes and effective depths of tapped holes are listed below. Be careful not to let the ends of bolts project from the holes. If necessary, use the additional reamed holes that are provided for positioning purpose.

(Two reamed holes are provided, one on the motor side and the other on the counter-motor side. One oblong hole is provided on the counter-motor side.)

Pay attention when selecting the bolt length. If an inappropriate bolt is used, the tapping hole may be damaged, actuator installation strength may drop, or contact with the driving parts may occur, resulting in lower precision or unexpected accidents.

Type	Tap size	Pitch (A)	Maximum screw depth	Minimum length of screw engagement	Reamed hole	Oblong hole
RCS3(P)-SA8	M5	60	10 mm	5 mm	∅5H7, depth 6 mm or less	B: 5H7, C: 6, depth 6 mm or less
RCS3(P)CR-SA8	M5	60	10 mm	5 mm	∅5H7, depth 6 mm or less	B: 5H7, C: 6, depth 6 mm or less
RCS3(P)-SS8	M8	45	10 mm	8 mm	∅5H7, depth 6 mm or less	B: 5H7, C: 6, depth 6 mm or less
RCS3(P)CR-SS8	M8	45	10 mm	8 mm	∅5H7, depth 6 mm or less	B: 5H7, C: 6, depth 6 mm or less



Caution: When using an aluminum-based actuator

If the length of engagement of the screw to be attached into the tapped hole is 5/8 or smaller than the maximum screw depth of the tapped hole, reduce the torque to 70 to 80% of the specified torque before tightening the screws.

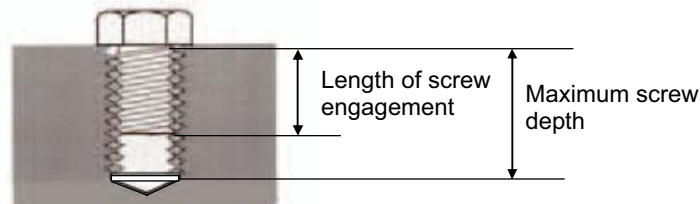

5.3.2 Using the Mounting Holes on Top of the Base (SA4 of 200 mm or Shorter Strokes/SA5 of 300 mm or Shorter Strokes)

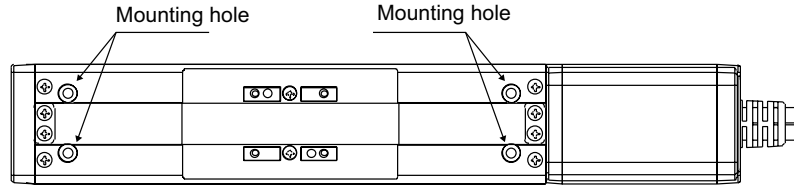

Four through holes (two on the motor side and two on the counter-motor side) are provided in the base for installing the actuator on its top face. Use these mounting holes to install the actuator.

When installing the actuator using these mounting holes alone, take heed of the following points:

1. SA4: Applicable to models of 200 mm or shorter strokes only
2. SA5: Applicable to models of 300 mm or shorter strokes only
3. SA6: Mounting holes are not provided.

If any model other than those specified in 1 and 2 (longer stroke) is installed using the mounting holes alone, the base may deform and the slider may slide abnormally, generate noise or present other problems.

As for mounting bolts, use hexagon socket-head bolts conforming to the applicable specification in the table below in accordance with the machine frame material.

If necessary, the reamed holes/oblong holes can be used as positioning pin holes. [Refer to 5.3.1.]

Type	Mating material is steel	Mating material is aluminum
SA4	M3, length 35 mm or more	
SA5	M4, length 40 mm or more	M4, length 45 mm or more

5.3.3 Using Foot Bases (Optional)

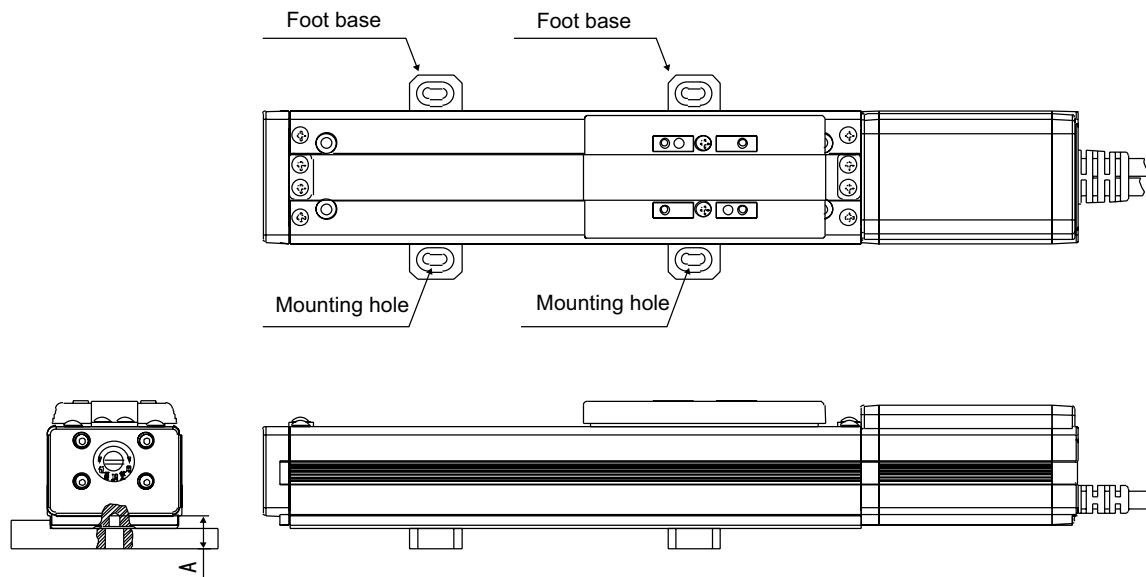

By using foot bases (optional), the actuator can be installed on its top face using the mounting holes in the foot bases.

Foot bases provide an effective means for installing the SA4 models of strokes exceeding 200 mm, S5A models of strokes exceeding 300 mm, or all SA6 models.

As for mounting bolts, use hexagon socket-head bolts and flat washers conforming to the applicable specification in the table below in accordance with the machine frame material.

If necessary, the reamed holes/oblong holes can be used as positioning pin holes. [Refer to 5.3.1.]

The depth of reamed holes/oblong holes must conform to dimension A. (Dimension A considers the foot base thickness.)

Type	Mating material is steel	Mating material is aluminum	Flat washer	Dimension A
SA4	M4, length 8 mm or more	M4, length 12 mm or more	Nominal diameter 4	12 mm
SA5	M4, length 8 mm or more	M4, length 12 mm or more	Nominal diameter 4	13 mm
SA6	M5, length 10 mm or more	M5, length 15 mm or more	Nominal diameter 5	14 mm

5.4 Installation Surface

- The mounting table should have sufficient rigidity to avoid generating vibration.
- The surface where the actuator will be mounted should be machined or be equally level and the flatness tolerance between the actuator and the table should be within ± 0.05 mm.
- Provide enough space around the actuator to permit maintenance work to be done.

5.4.1 Using Side Faces of the Base as Reference Planes

[RCS2 (CR)]

- The side and bottom faces of the actuator base provide the reference planes for slider travel.
- When precision is required, use these surfaces as the reference planes for mounting.

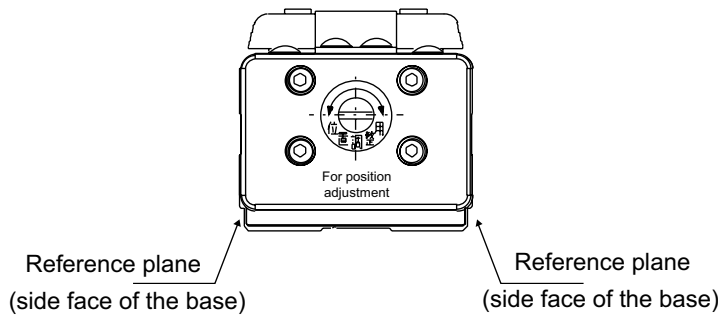

Caution: As shown above, the side faces of the base provide the reference planes for slider travel. When precision is required, use these surfaces as the reference planes for mounting.

When using the base as the reference planes for mounting the actuator to the machine frame, follow the machining dimensions shown below.

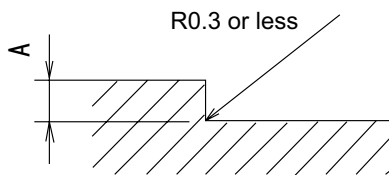

Type	Dimension A [mm]
SA4	2 to 3
SA5	2 to 4.5
SA6	2 to 4.5
SA7	2 to 5.5
SS7	2 to 4
SS8	2 to 4.5

[RCS3(P) (CR)]

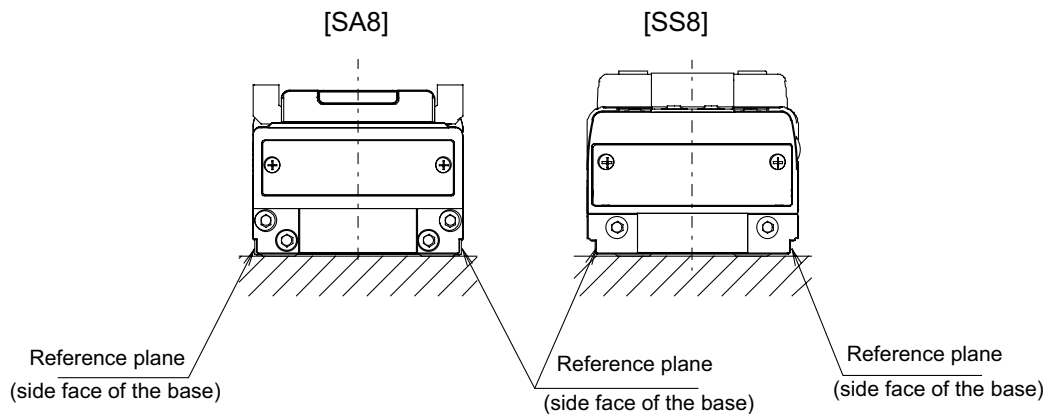

Caution: As shown above, the side faces of the base provide the reference planes for slider travel. When precision is required, use these surfaces as the reference planes for mounting.

When using the base as the reference planes for mounting the actuator to the machine frame, follow the machining dimensions shown below.

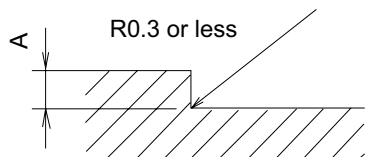

Model	Dimension A [mm]
RCS3(P) (CR)-SA8	2 to 4.5 or less
RCS3(P) (CR)-SS8	

5.4.2 Using Side Faces of the Foot Base as Reference Planes (If Equipped with Optional Foot Bases)

- The side faces of the foot base provide the reference planes for slider travel.
- When precision is required, use these surfaces as the reference planes for mounting.

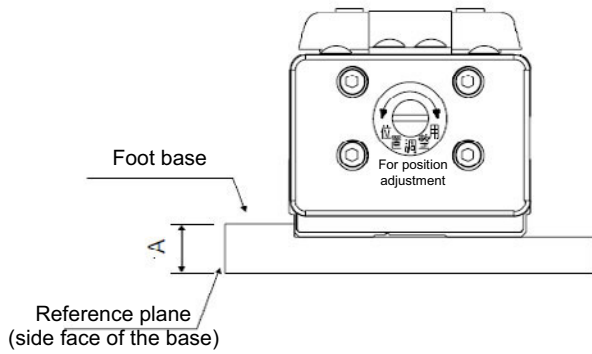

Type	Dimension A
SA4	9.5 mm
SA5	11 mm
SA6	12 mm

5.5 Tightening Screws

- The male screws for mounting the base should be M3 for SA4, M4 for SA5, M5 for SA6/SA7/SS7, and M8 for SS8. (Use hexagon socket-head bolts).
- For the bolts, we recommend high strength bolts of ISO-10.9 or higher.
- When using a foot base to attach to a mounting table, use the special washer made for high strength bolts that comes with the actuator if the bolt is M8 or larger. This is unnecessary for M6 or smaller bolts. Do not use a common spring washer.
- The recommended tightening torque is given below.

Screw nominal diameter	Tightening Torque	
	When the bolt seating surface is steel	When the bolt seating surface is aluminum
M3	1.5 N·m (0.15 kgf·m)	0.8 N·m (0.08 kgf·m)
M4	3.6 N·m (0.37 kgf·m)	1.8 N·m (0.18 kgf·m)
M5	7.3 N·m (0.74 kgf·m)	3.4 N·m (0.35 kgf·m)
M8	30.0 N·m (3.05 kgf·m)	11.5 N·m (1.17 kgf·m)

5.6 Installing the Load on the Slider

5.6.1 Using the Slider

- The slider has tapped holes, so affix the load using these holes. The method of clamping varies according to how to mount the main body.
- In case of moving actuator instead of slider, use the same tapped holes on the slider.
- Please use two reamed holes on the slider when repeatability of mounting and dismounting is required. When fine adjustment of the squareness is necessary, use only one reamed hole to allow adjustment.

[RCS2(CR)]

Sizes and depths of tapped holes and reamed holes on slider

Model	Tap size	Depth of thread	A	B	C	Reamed hole
SA4	M3	7 mm	24 mm	16 mm	20 mm	∅3 H7, depth 5 mm
SA5	M4	9 mm	30 mm	19 mm	26 mm	∅4 H7, depth 6 mm
SA6	M5	9 mm	50 mm	32 mm	31 mm	∅5 H7, depth 6 mm
SA7	M5	10 mm	50 mm	32 mm	39 mm	∅5 H7, depth 10 mm
SS7	M5	10 mm	50 mm	32 mm	32 mm	∅5 H7, depth 10 mm
SS8	M8	10 mm	75 mm	45 mm	45 mm	∅8 H7, depth 10 mm

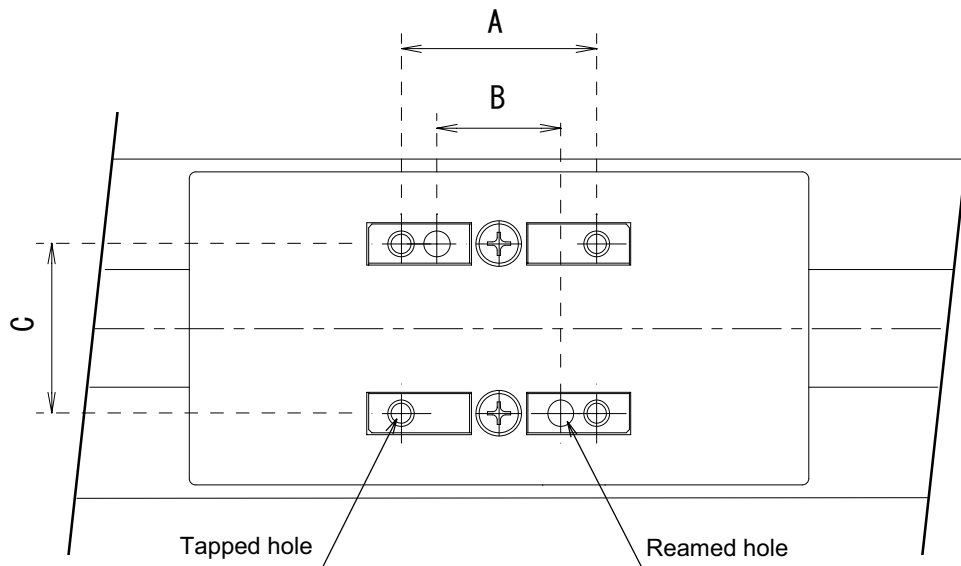

⚠ Caution: When installing the load, do not let adhesives, paints or other viscous substances attach the stainless sheet. Also, avoid applying a concentrated force that will dent the sheet. It may cause the slider to malfunction or damage the sheet.

[RCS3(P) (CR)]

[RCS3(P)-SA8 standard type]

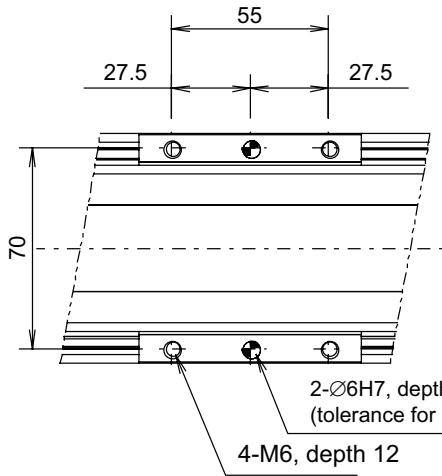

[RCS3(P)-SA8 CR type]

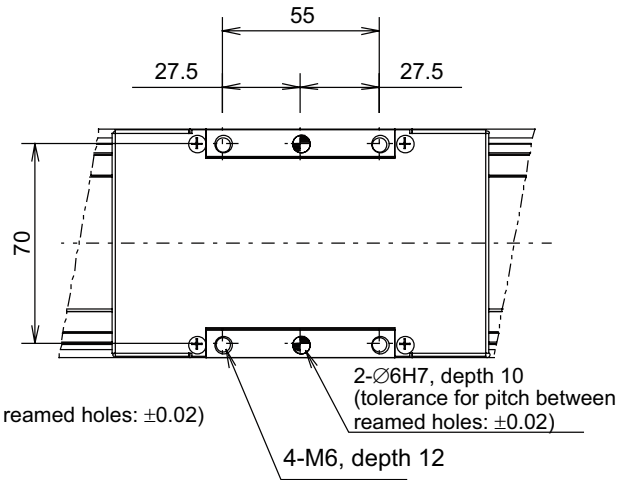

[RCS3(P)-SS8 standard type, RCS3(P)CR-SS8 CR type]

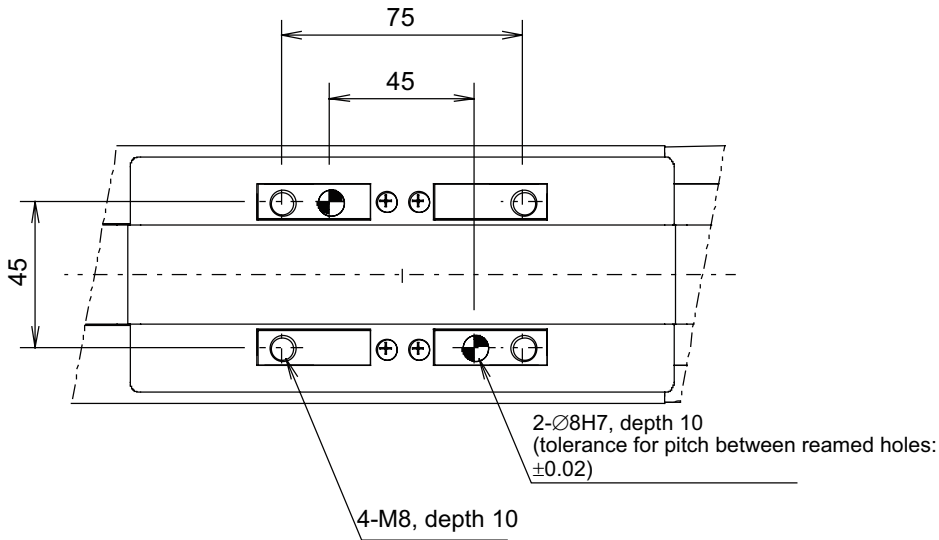

Caution: When installing the load, do not let adhesives, paints or other viscous substances attach the stainless sheet. Also, avoid applying a concentrated force that will dent the sheet. It may cause the slider to malfunction or damage the sheet.

5.6.2 Using a Slider Spacer (Optional) (Optional for SA4 Type)

For the SA4 type, a slider spacer is available as an option.
The figure below shows the positions of load-mounting holes in actuators with a slider spacer.

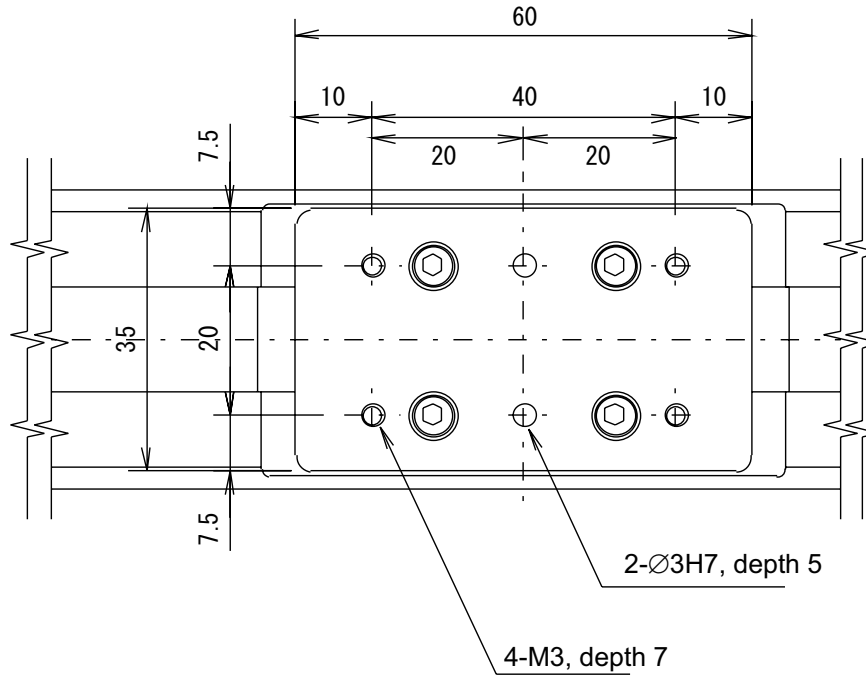

5.7 Cleanroom Specification

⚠ Caution: The clean room types listed below cannot be guaranteed to meet Cleanliness Class 10 if they are installed in the vertical orientation, the horizontally wall mounted orientation or in the ceiling mounted orientation since they do not possess a structure to grip the stainless steel sheet from the side cover.
 Please contact us if it is necessary to install the following models in an orientation other than the horizontal orientation.
 Actuator Model : RCS2CR-SA5D, RCS2CR-SA6D

5.7.1 Suction Rate

Air inside the actuator must be suctioned to ensure that the actuator operates in conformance with the requirements of cleanliness class 10.

Provide an air tube and connect it to a quick joint (outer diameter $\varnothing 6$) provided at the suction section, and connect the other end of the tube to a vacuum pump, blower, ejector, etc., to suction at an applicable flow rate as specified below.

[RCS2CR]

Lead	Recommended suction rate
2.5 mm/3 mm	15 NI/min
5 mm/6 mm	30 NI/min
10 mm/12 mm/16 mm	50 NI/min
10 mm (SS8)	40 NI/min
20 mm	80 NI/min

[RCS3(P)CR]

Type	Lead	Recommended suction rate
SA8	5 mm	30 NI/min
SA8	10 mm	60 NI/min
SA8	20 mm	110 NI/min
SA8	30 mm (speed not exceeding 1500 mm/s)	130 NI/min
SA8	30 mm (speed exceeding 1500 mm/s)	160 NI/min
SS8	5 mm	30 NI/min
SS8	10 mm	80 NI/min
SS8	20 mm	120 NI/min
SS8	30 mm (speed not exceeding 1500 mm/s)	160 NI/min
SS8	30 mm (speed exceeding 1500 mm/s)	190 NI/min

5.7.2 Suction Joint

Remove the plug from either quick joint and insert an air tube to suction air from either the motor side or counter-motor side.

Remember to cover the unused joint with a plug.

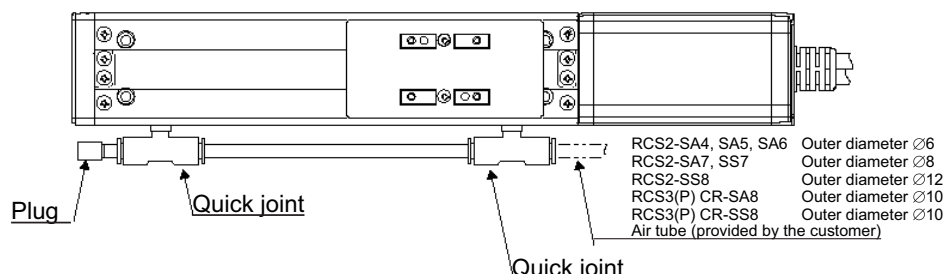

6. Connection with Controllers

6.1 Wiring

- In an application where the cable cannot be anchored, try to place the cable so that it sags only under its own weight or use self-standing type cable as large radial wire duct to limit the load on the cable.
- Never cut and/or reconnect the cables supplied with the product for the purpose of extending or shortening the cable length.
- The cables supplied with the actuator offer excellent flexibility, but they are not robot cables.
- If the cables are to be stored in a movable cable duct (cable track, etc.), use robot cables.

For cable modification, please contact your IAI sales representative.

[Connection with SCON/SSEL Controllers]

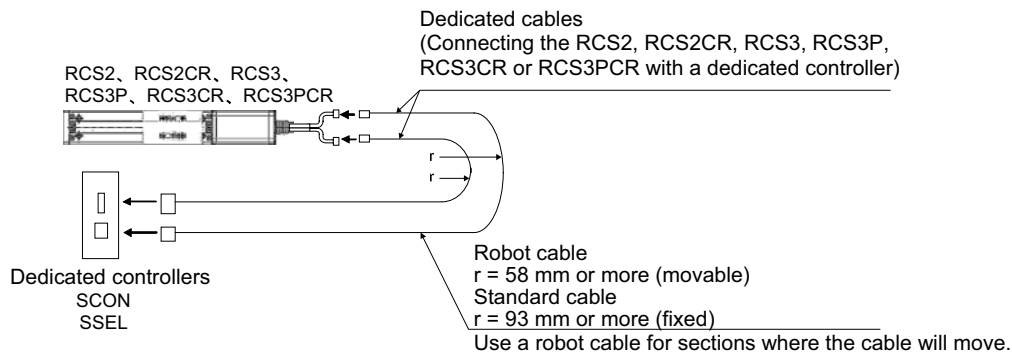

Dedicated cables

- Motor cable CB-RCC-MA^{***} / Robot motor cable CB-RCC-MA^{***}-RB
 - Encoder cable CB-RCS2-PA^{***} / Robot encoder cable CB-X3-PA^{***}-RB
- ^{***} indicates the cable length. A desired length up to 30 m can be specified.
Example) 080 = 8 m

[Connection with X-SEL Controllers]

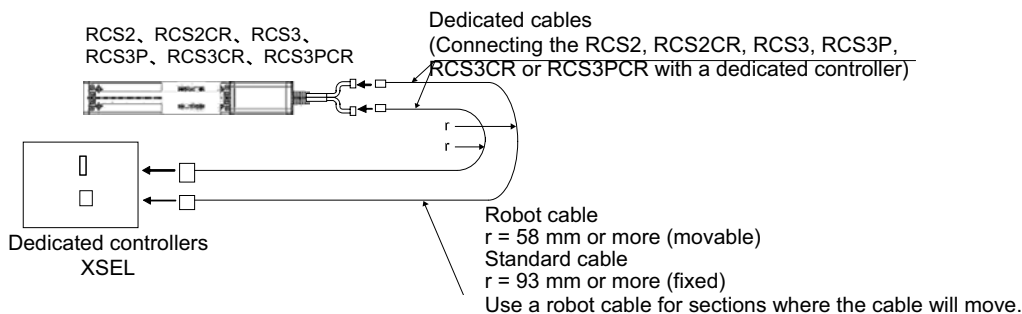

Dedicated cables

- Motor cable CB-RCC-MA^{***} / Robot motor cable CB-RCC-MA^{***}-RB
 - X-SEL-J/K encoder cable CB-RCBC-PA^{***} / X-SEL-J/K robot encoder cable CB-RCBC-PA^{***}-RB
 - X-SEL-P/Q encoder cable CB-RCS2-PA^{***} / X-SEL-P/Q robot encoder cable CB-X3-PA^{***}-RB
- ^{***} indicates the cable length. A desired length up to 15 m can be specified.

For other cables, a desired length up to 20 m can be specified.

Example) 080 = 8 m

When building an application system using actuators and controllers, inappropriate wiring and connection of cables may result in wire breakage, poor contact and other unexpected problems. Prohibited items regarding the handling of cables are explained below.

- Do not cut to extend or shorten the cable or reconnect the cut cable.
- If the cable cannot be secured in place, allow it to bend only within the range of deflection by its self-weight or use a self-supporting cable hose, etc., to ensure a large wiring radius in order to reduce the load applied to the cable.
- Do not let the cable bend sharply at a single location.

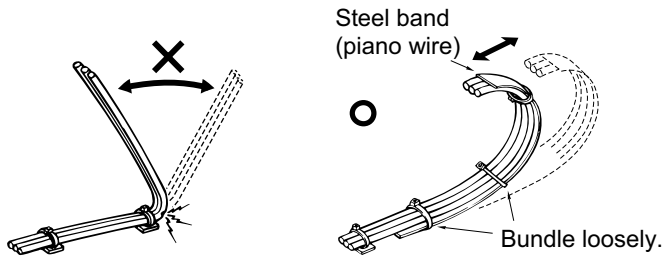

- Do not let the cable flex at a single point.

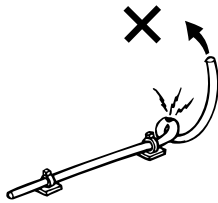

- Do not let the cable receive a turning force at a single point.

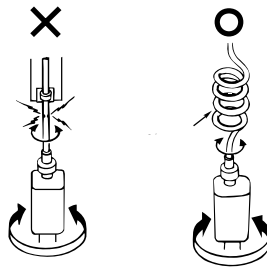

- Do not pull the cable with a strong force.

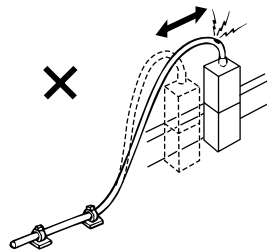

- Do not pinch, drop a heavy object onto or cut the cable.

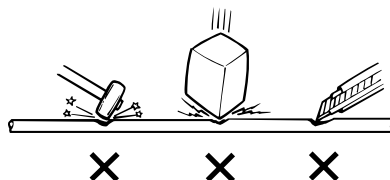

- When fixing the cable, provide a moderate slack and do not tension it too tight.

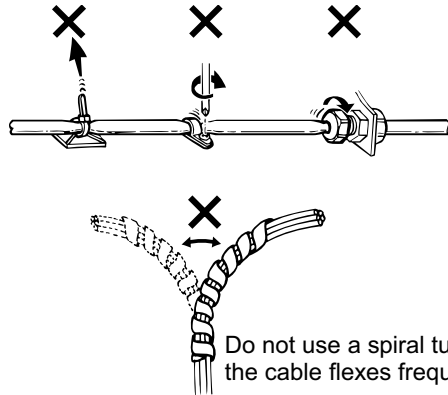

- Separate the I/O lines and communication lines from the power/drive lines. Do not bundle them together in the duct.

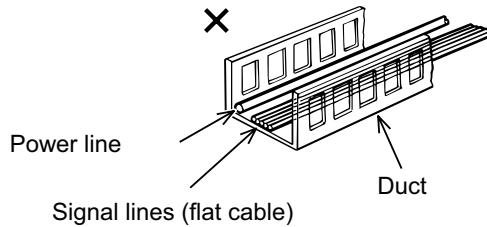

Follow the instructions below when using a cable track.

- If there is an indication to the cable for the space factor in a cable track, refer to the wiring instruction given by the supplier when storing the cable in the cable track.
 - Avoid the cables to get twined or twisted in the cable track, and also to have the cables move freely and do not tie them up. (Avoid tension being applied when the cables are bent.)
- Do not pile up cables. It may cause faster abrasion of the sheaths or cable breakage.

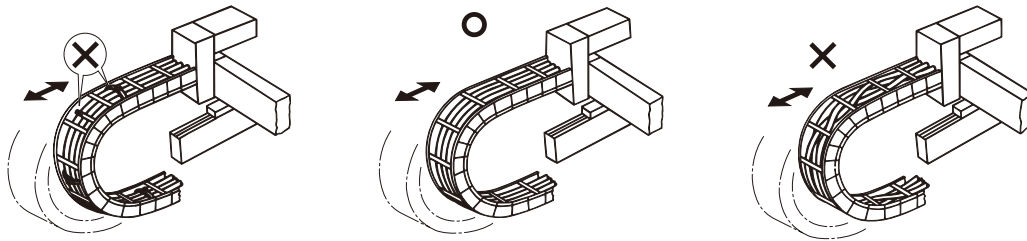

Warning:

- When connecting or disconnecting any cable, be sure to turn off the controller power first. If a cable is connected or disconnected while the power is still supplied, the actuator may malfunction and a serious injury or equipment damage may result.
- Be sure to confirm that all connectors are firmly in place, because any loose connector may cause the actuator to malfunction and create a dangerous situation.

7. Setting the Home

7.1 Home Return

Home return consists of the following operations:

- [1] When a home command is issued, the actuator moves in the direction set by the moving direction parameter.
- [2] The actuator detects the mechanical end via software.
- [3] At the mechanical end, the actuator reverses its direction and moves until a Z-phase signal is detected, where the reference point is set.
- [4] The actuator moves further by the offset set by the applicable parameter, and the achieved position is set as the home.

7.2 Fine-tuning the Home Position

How much the motor should turn after the stopper is contacted until a Z-phase signal generates has been adjusted prior to shipment. The table below lists standard values set on respective models for the distance travelled after the slider contacts and reverses its direction at the stopper, until it stops at the home.

	Model name	Distance to home from mechanical stopper or home sensor (approx. value in mm)
RCS2RCS2CR	SA4C, SA5C, SA6C, SA7C, SA4R, SA5R, SA6R, SA7R, SA8C, SS8C	3 mm
	SA4D	2.2 mm
	SA5D, SA6D	3 mm
	SS7C, SS8C, SA7R, SS8R	5 mm
RCS3(P)RCS3(P)CR	SA8C, SA8R, SS8C, SS8R	3 mm

As long as the direction of home return remains the same, the home position of each actuator can be fine-tuned by changing the parameter. Follow the procedure below to fine-tune the home position:

- [1] Perform home return to check the current home.
- [2] Next, move to a desired home, check the difference between the two homes, and then correct the home preset parameter if you are using an XSEL or SSEL controller, or correct the home return offset parameter if you are using a SCON controller, accordingly.
Add or subtract the difference to/from the value currently set.
- [3] If a large offset is specified, the moving range will be reduced by the corresponding amount.
If an offset beyond 1 mm is set, adjust the stroke limits.

7.3 Changing the Direction of Home

To change the direction of home on the delivered actuator, the moving direction parameter, and also the encoder's Z-phase on some models, must be adjusted. Consult IAI for details.

7.4 How to Use the Home Mark

- ◆ Please affix these marks to the actuator as home markers as needed.

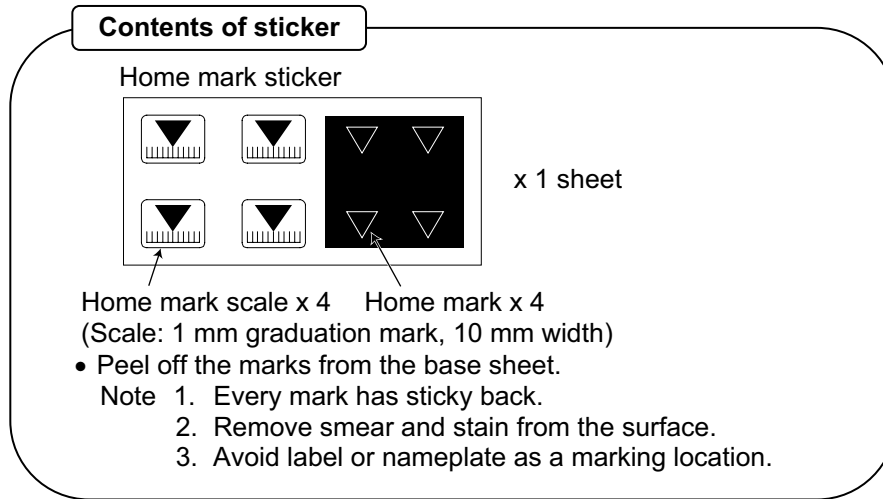

Example of Use

- [1] Attach the seals as a guide for the direction of actuator home.

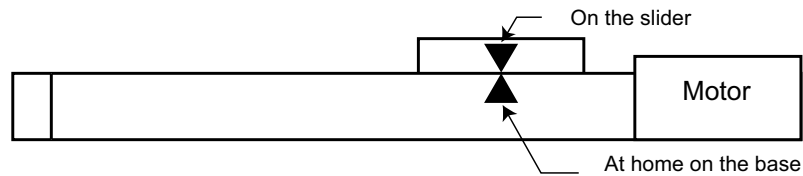

- [2] Attach the seals as a guide for stop positions

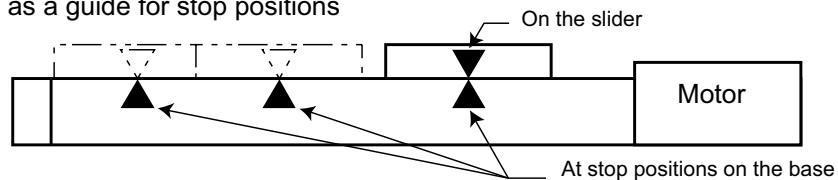

- [3] Attach the seals as a guide for position deviation check.

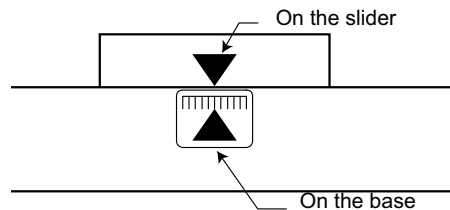

- Attach the two seals while the actuator is stopped at its home.

7.5 How to Set the Home Preset and Home Return Offset

To correct a position deviation, change the home preset parameter if you are using an X-SEL or SSEL controller, or change the home return offset parameter if you are using a SCON controller. How to set these parameters is explained below.

7.5.1 X-SEL or SSEL Controller

- Open the position edit screen.
On the PC software screen, click  select [Select Position No.], and then click [OK]. The following screen will appear.

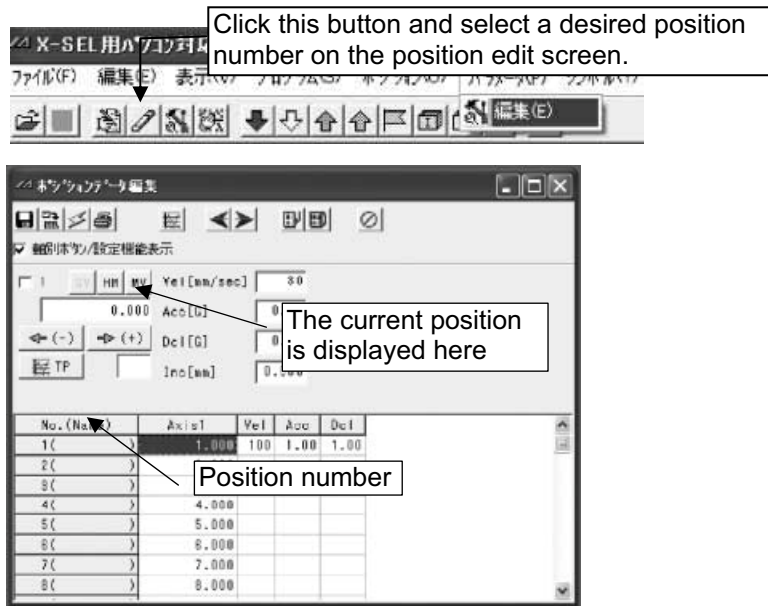

- Compare the current position and the position of the desired position number you have selected, to check the difference between the two.

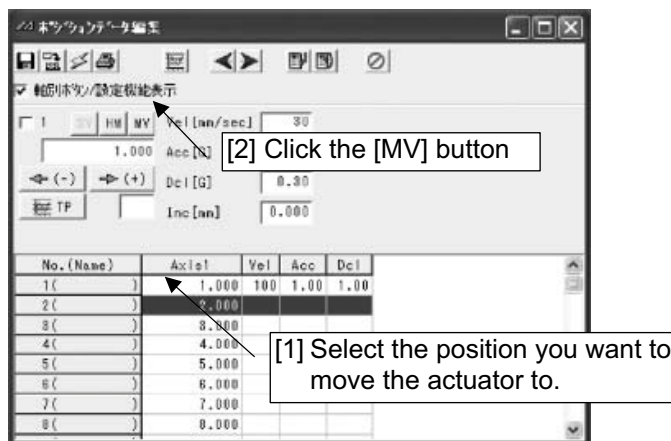

- (3) Click the parameter button.



Click this button to open the parameter edit screen.

- (4) Select "Axis-specific Parameters."

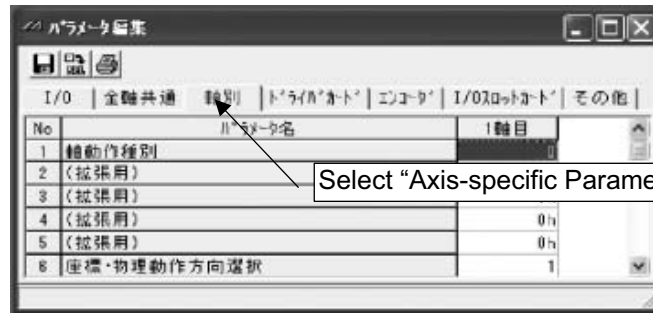

Select "Axis-specific Parameters."

- (5) When the axis-specific parameter screen opens, select No. 12, "Home preset."

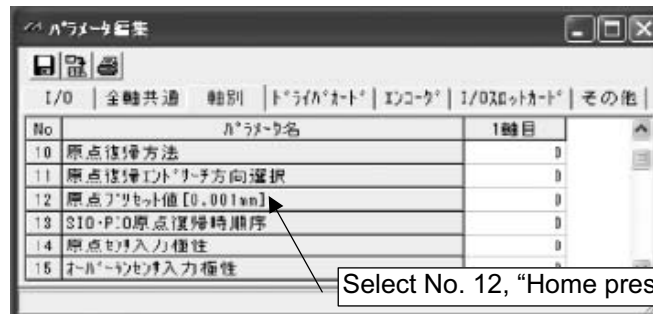

Select No. 12, "Home preset."

- (6) Change the setting of Axis-specific Parameter No. 12 (home preset).
 Add or subtract the value measured in (2) to/from the value currently entered.
 The setting unit is 0.001 mm.
 Example: If the difference is "-1 mm":
 Home preset = Current setting - 1000

- (7) Write the new data.

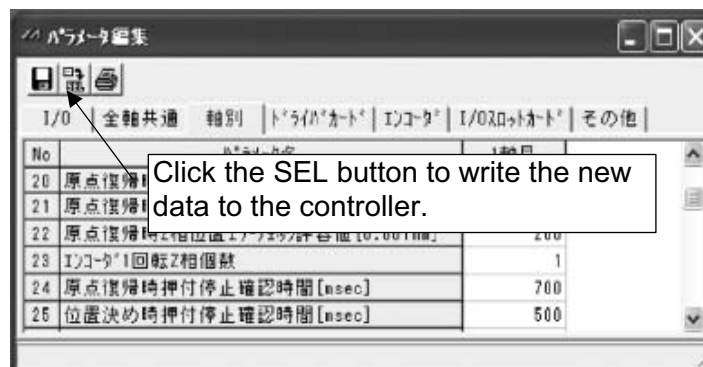

Click the SEL button to write the new data to the controller.

(8) Transfer the data to the controller.

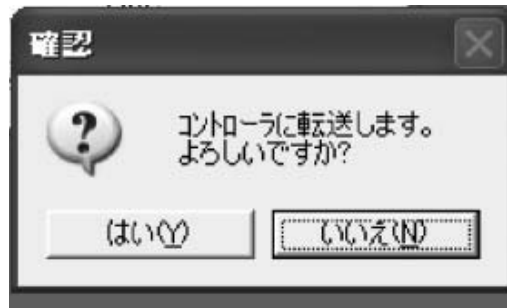

(9) Click [OK].



(10) Write the data to the flash ROM.

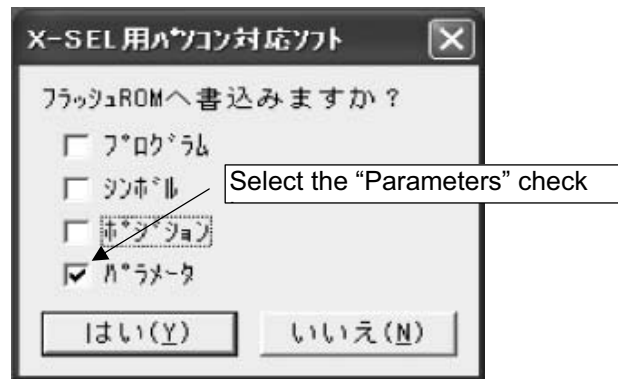

(11) Restart the controller.



7.5.2 ECON or SCON Controller

- Open the position edit screen.
On the PC software screen, click , select [Select Position No.], and then click [OK]. The following screen will appear.



Click this button and select a desired position number on the position edit screen.

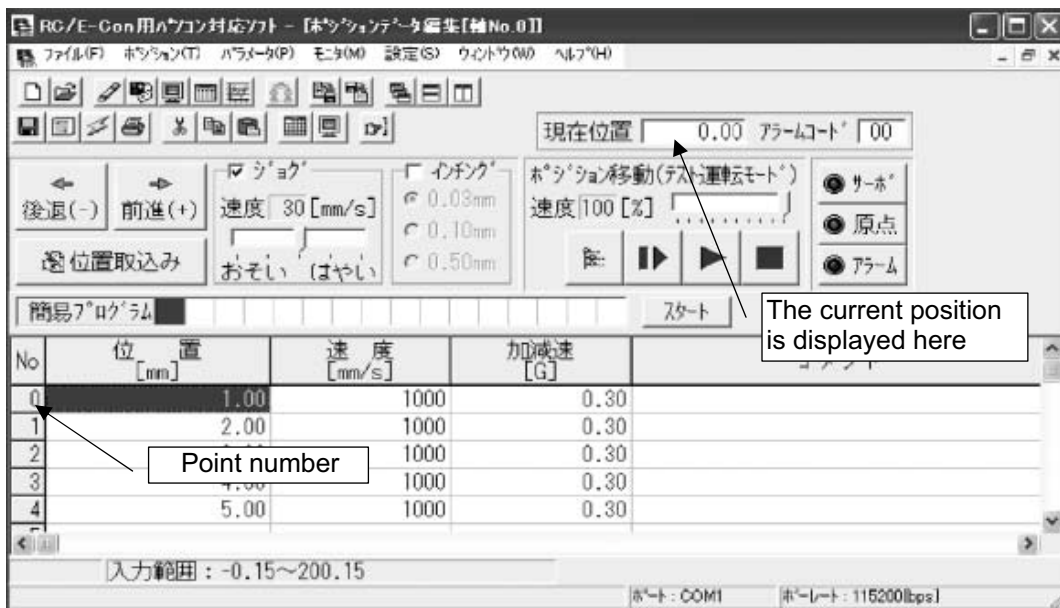

- Compare the current position and the position of the desired position number you have selected.

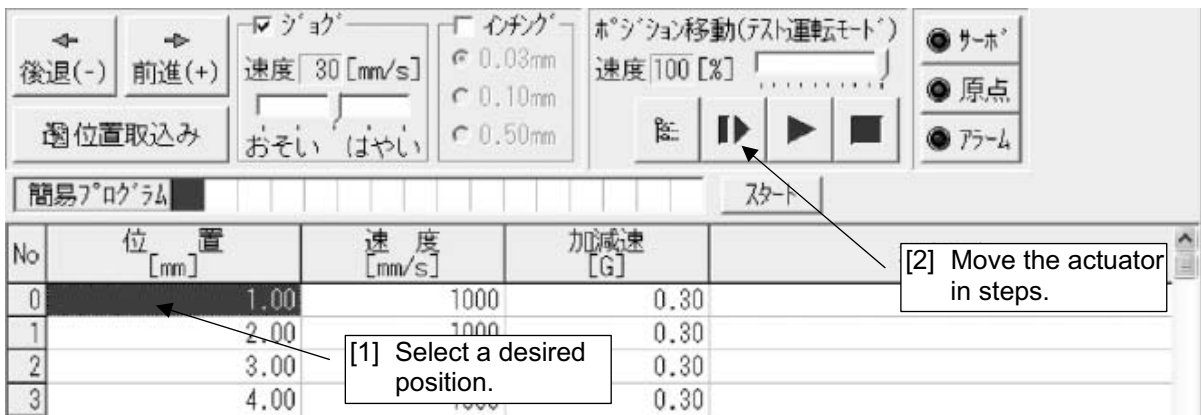

- (3) Click the parameter button.



- (4) Open the user parameter screen.

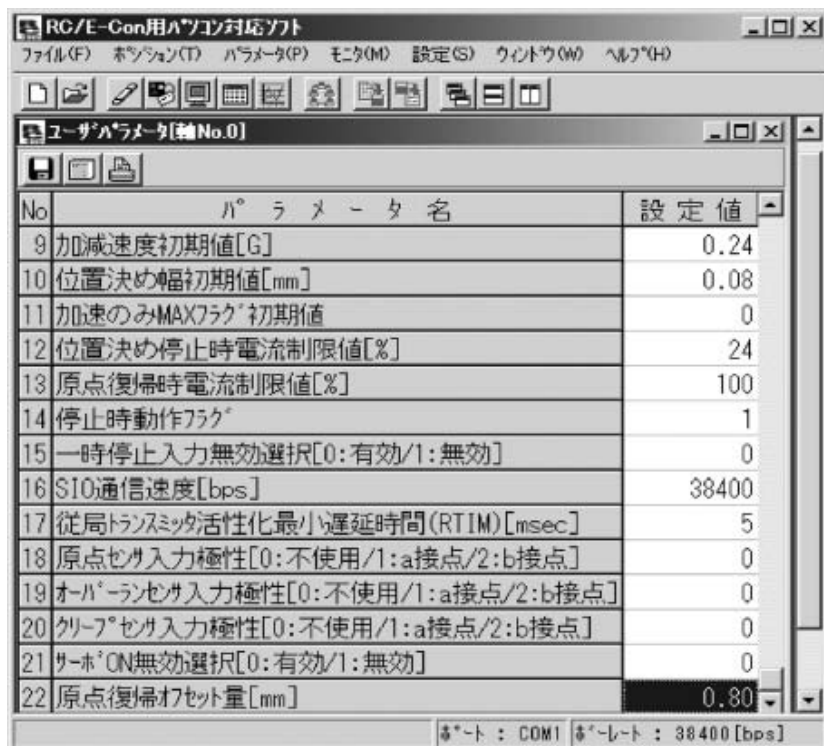

- (5) Change the setting of User Parameter No. 22 (home return offset).
 * The setting unit is mm.
 Add or subtract the value measured in (2) to/from the value currently entered.
 Example: If the difference is "-0.5 mm":
 Home return offset = Current setting - 0.5 mm

- (6) Write the new data.
Click the transfer to controller button, and then click [OK].
* Turn the power off after writing.



8. Slit for Position Adjustment

A hole is provided in the front cover on the counter-motor side, with a slit machined on the ball screw shaft. Use this slit if you want to fine-tune the slider position (for direct teaching, etc.). Insert a screwdriver with an outer diameter of $\varnothing 8$ mm or less into the slit, and turn the driver.

[RCS2 (CR)]

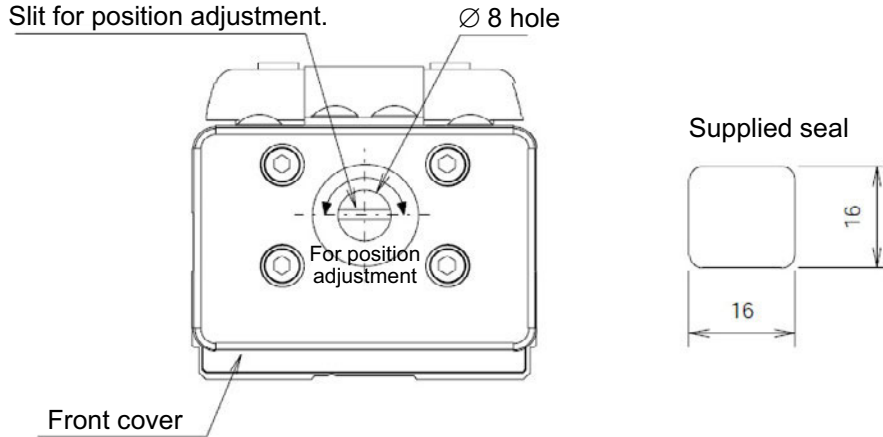

[RCS3(P)(CR)]

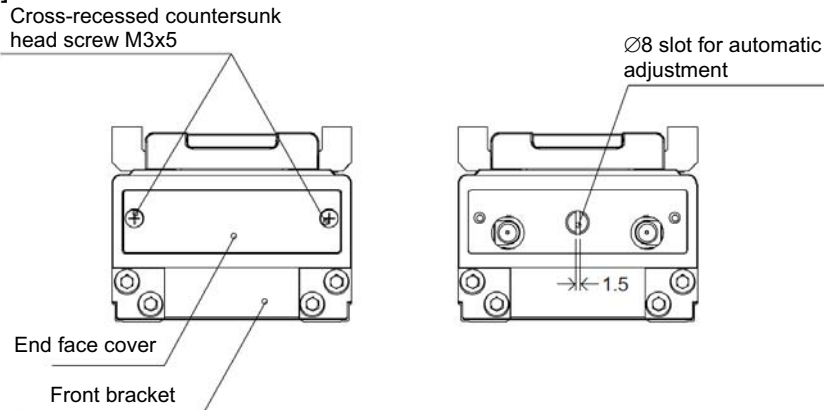

Caution: Be sure to operate the slit when the servo is off. Do not insert a finger or object in this hole while the slider is moving, as it is very dangerous. While the slit is not in use, attach the supplied seal or equivalent to cover the hole. If the hole remains exposed, a finger or object may enter accidentally, creating a very dangerous situation. With the cleanroom specification, leaving this hole open may cause dust and other particles inside the actuator to escape through the hole and affect the cleanliness of the operating room.

9.3 High Acceleration/Deceleration Option

With this option, the maximum acceleration becomes 1.0 G (or 0.8 G on some models) instead of 0.2 G or 0.3 G on standard specification models.

The actuator can operate at the maximum acceleration of 1.0 G (or 0.8 G on some models) while keeping the same payload capacity as its standard specification counterpart.

To move an actuator with the high acceleration/deceleration option, a controller of high acceleration/deceleration specification is required. This controller is different from a standard specification controller. The model number for this option is "HA."

9.4 Home Check Sensor

The actuator comes with a sensor that checks if the slider has actually moved to the home position as a result of home return.

The model number for this option is "HS."

9.5 Reversed Home Specification

When the reversed home specification is selected, the home is set on the front side. The model number for this option is "NM." To change the direction of home on the delivered actuator, the moving direction parameter, etc., must be adjusted. Consult IAI for details.

9.6 Slider Roller Specification

The slider structure is changed to the same roller structure adopted by the clean room specification.

The model number for this option is "SR."

9.7 Slider Spacer

When the spacer option is selected for the SA4 slider, the position of the slider's top surface becomes higher than the motor position. The applicable code for this option is "SS."

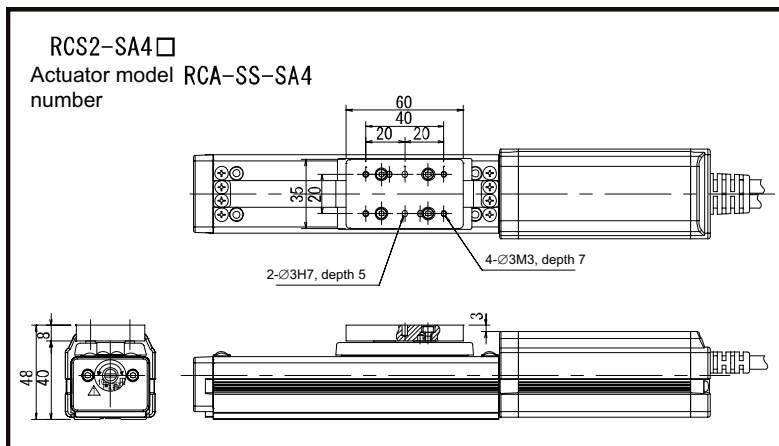

9.8 Motor Reversed to Left, Motor Reversed to Right

“ML” indicates that the motor is reversed to the left, while “MR” indicates that the motor is reversed to the right, as viewed from the motor.

This option can be specified for the motor reversing types SA4R, SA5R, SA6R, SA7R, SS7R and SS8R.

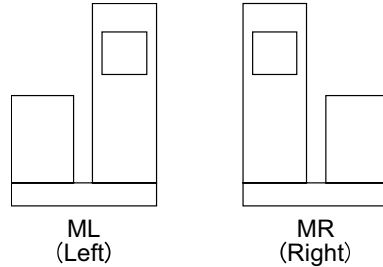

9.9 Changing the Cable Exit Direction

The cable exit direction is changed. The model numbers are as follows:

- A1S: Cable exit from left side
- A1E: Cable exit from rear left
- A3S: Cable exit from right side
- A3E: Cable exit from rear right

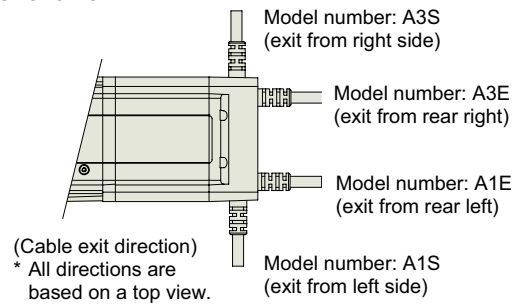

9.10 Changing the Motor Reversing Direction (Left/Right) and Cable Exit Direction

Whether the motor is reversed to the left or right, and the cable exit direction, is changed.

The model numbers are shown below.

The specified motor reversing types are RCS3/RCS3P-SA8R and SS8R.

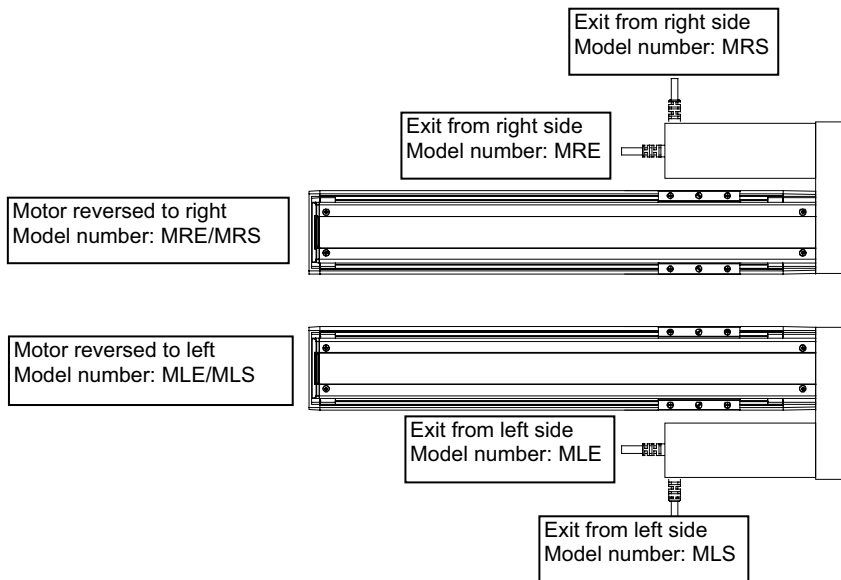

9.11 Suction Joint on Opposite Side

Standard clean room actuators come with a suction joint set on the left side as viewed from the motor. With this option, this joint is set on the front (opposite) side. The model number for this option is "VR."

9.12 No Suction Joint

No suction joint is provided. The applicable code for this option is "VN."

10. Motor/Encoder Cables

- [1] Motor Cables/Motor Robot Cables
 Model number: CB-RCC-MA□□□/CB-RCC-MA□□□-RB

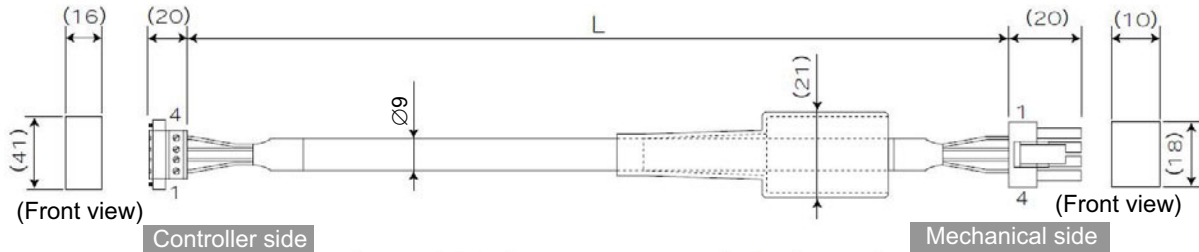

Wire	Signal	No.	No.	Signal	Wire
0.75sq (Crimping)	PE	1	1	U	0.75sq (Crimping)
	U	2	2	V	
	V	3	3	W	
	W	4	4	PE	

- [2] Encoder Cables/Encoder Robot Cables (For X-SEL-J/K)
 Model number: CB-RCBC-PA□□□/CB-RCBC-PA□□□-RB

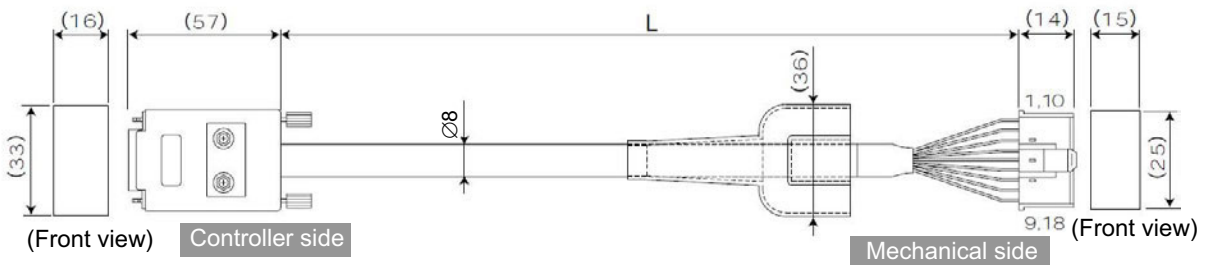

Wire	Signal	No.	No.	Signal	Wire
0.15sq (Crimping)	A/U	1	1	A/U	0.15sq (Crimping)
	A/Ū	2	2	A/Ū	
	B/V	3	3	B/V	
	B/∇	4	4	B/∇	
	Z/W	5	5	Z/W	
	Z/Ū	6	6	Z/Ū	
	SD	7	7	—	
	SD	8	8	—	
	BAT+	9	9	FG	
	BAT-	10	10	SD	
	VCC	11	11	SD	
	GND	12	12	BAT+	
	BK-	13	13	BAT-	
	BK+	14	14	VCC	
	—	15	15	GND	
Connect the shield to the hood using a clamp.					
Ground wire and braided					
			16	—	
			17	BK-	
			18	BK+	

[3] Encoder Cables/Encoder Robot Cables (For SCON, SSEL and X-SEL-P/Q)
 Model number: CB-RCS2-PA□□□/CB-X3-PA□□□

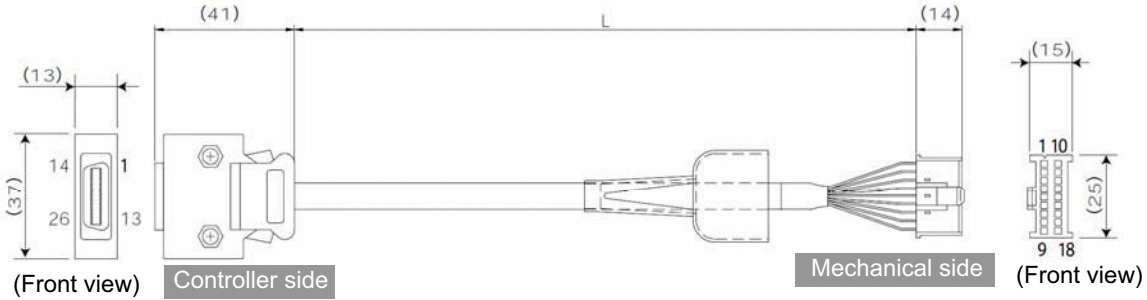

Wire	Color	Signal	No.
—	—	—	10
—	—	—	11
—	—	E24V	12
Gray/White	—	OV	13
Brown/White	—	LS	26
—	—	CLEEP	25
—	—	OT	24
—	—	RSV	23
—	—	—	9
—	—	—	18
—	—	—	19
Pink	—	A+	1
Purple	—	A-	2
White	—	B+	3
Blue/Red	—	B-	4
Orange/White	—	Z+	5
Green/White	—	Z-	6
Blue	—	SRD+	7
Orange	—	SRD-	8
Black	—	BAT+	14
Yellow	—	BAT-	15
Green	—	VCC	16
Brown	—	GND	17
Gray	—	BKR-	20
Red	—	BKR+	21
—	—	—	22

Connect the shield to the hood using a clamp.

Note 3

Note 4

Note 1

Ground wire and braided

Note 2

No.	Signal	Color	Wire
1	A	Pink	AWG26 (Crimping)
2	A	Purple	
3	B	White	
4	B	Blue/Red	
5	Z	Orange/White	
6	Z	Green/White	
7	LS+	Brown/White	
8	—	—	
9	FG	Ground	
10	SD	Blue	
11	SD	Orange	
12	BAT+	Black	
13	BAT-	Yellow	
14	VCC	Green	
15	GND	Brown	
16	LS-	Gray/White	
17	BK-	Gray	
18	BK+	Red	

11. Maintenance and Inspection

11.1 Inspection Items and Schedule

Perform maintenance work according to the schedule below.

The schedule is set assuming eight hours of operation a day. When the operation time is long such as 24-hour operation, shorten the maintenance intervals as needed.

	Visual inspection	Check interior	Grease supply ^{*2}
Start of operation	○		
After 1 month of operation	○		
After 6 months of operation	○	○	○ ^{*1}
After 1 year of operation	○	○	○
Every 6 months thereafter	○		
Every 1 year	○	○	○

*1 If grease is found degraded as a result of interior check, add grease.

*2 If continuous back-and-forth operations are performed over a distance of 30 mm or less, grease film may be broken. As a guide, operate the actuator back and forth five times or so over a distance of 50 mm or more after every 5,000 to 10,000 cycles.

11.2 Visual Inspection of the Machine Exterior

Check the following items when carrying out visual inspection.

Body	Loose mounting bolts?
Cables	Damage to cables or connection to connector box?
Stainless sheet	Damage, foreign deposit or slacks?
General	Unusual noise or vibrations?

- If the stainless sheet is slacked, make adjustment as deemed necessary to remove the slacks.
- As a rough guide, the stainless sheet will last for 5,000 km of traveled distance. However, the stainless sheet should be replaced earlier depending on the condition of use. The stainless sheet must be replaced at an IAI site (the actuator must be brought to IAI) or at the customer's site by IAI's service personnel, as a rule.
- If the actuator is fixed vertically, grease applied to the guide may drip depending on the environment. If this happens, clean and add grease as necessary.

11.3 Cleaning

- Clean the exterior as needed.
- Wipe off dirt with a soft cloth.
- Do not use strong compressed air on the actuator as this may force dust into the crevices.
- Do not use petroleum-based solvent on plastic parts or painted surfaces.
- If the unit is badly soiled, apply a neutral detergent or alcohol to a soft cloth, and wipe gently.

11.4 Adjusting the Stainless Sheet

If the actuator stroke is 400 mm or more, check the stainless sheet for slacking, etc., as needed. If the sheet is found slacked, adjust the stainless sheet.

[For the procedure to adjust the stainless sheet, refer to 11.8, “Replacing/Adjusting the Stainless Sheet.”]

11.5 Interior Inspection

Turn off the power, remove the side covers, and then visually inspect the interior. Check the following items during interior inspection.

Body	Loose mounting bolts?
Guides	Lubrication appropriate? Soiling?
Ball screw	Lubrication appropriate? Soiling?

[RCS2 (CR)]

How to inspect the interior:

- 1) Remove both side covers.
Use an Allen wrench of 1.5 mm across flats.



Make a visual check of the interior to see if there is any dust or foreign matter in the unit and check the lubrication. Even if the grease you see around the parts is brown, the lubrication is fine as long as the traveling surface appears shiny.

- 2) If the grease becomes dirty and dull or if the grease has worn away due to extended operating time, lubricate the parts after cleaning them.
- 3) When the inspection/maintenance work is complete, install the side covers.
Tightening torque: Thin-head screw M3 x 6 – 87.2 N·cm (8.90 kgf·cm)

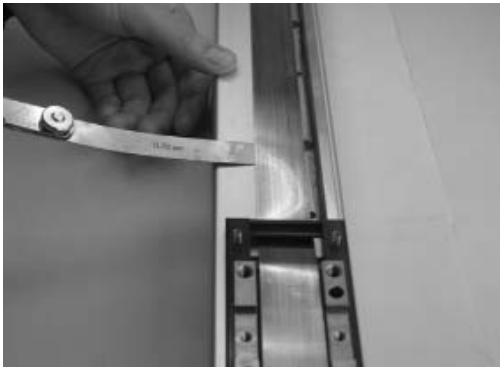

When installing the side covers, do not let them contact the end faces of the stainless sheet. It may damage or bend the stainless sheet, causing the sheet to deteriorate or wear quickly. To prevent this problem, insert a shim (approx. 0.1 to 0.2 mm) between the sheet and each cover to provide an allowance, and gently push in the cover.

- Caution:**
- When checking the interior, be careful not to bend or scratch the stainless sheet. Wear protective gloves when handling the stainless sheet, because it has sharp edges that may cause accidental cuts. The front cover is supporting the ball screw; so do not disassemble the front cover. If the front cover is misaligned, the shaft centers may become offset, thus increasing the traveling resistance, reducing the service life of each part, or generating noise.
 - If the actuator is equipped with a microswitch (optional), carefully install the side covers so that the switch cables are not pinched.

[RCS3(P) -SA8]

How to inspect the interior:

- 1) Use an Allen wrench of 2 mm across flats to remove the four screws and take out the screw cover.

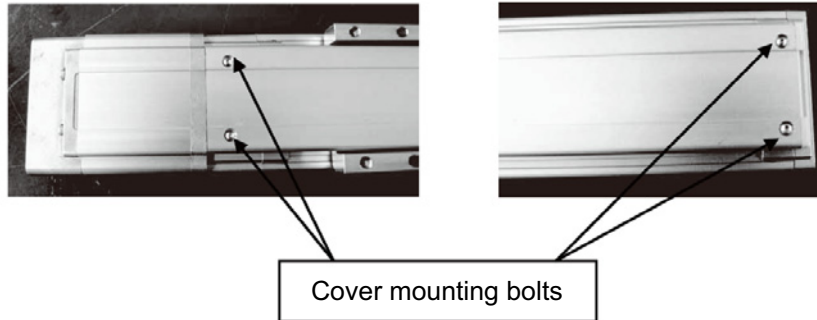

Make a visual check of the interior to see if there is any dust or foreign matter in the unit and check the lubrication. Even if the grease you see around the parts is brown, the lubrication is fine as long as the traveling surface appears shiny.

- 2) If the grease becomes dirty and dull or if the grease has worn away due to extended operating time, lubricate the parts after cleaning them.

3) Use an Allen wrench of 2 mm across flats to tighten the four screws to install the screw cover.

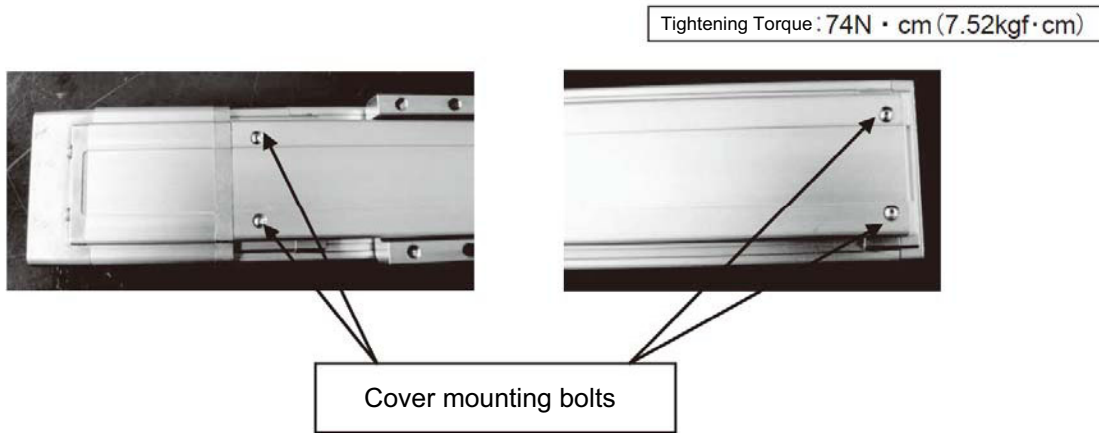

Caution: When checking the interior, be careful not to forcibly bend the screw cover or otherwise damage the cover.

The front cover is supporting the ball screw, so do not disassemble the cover.
If a proper adjustment of the front cover is lost, misalignment of the center of axis may cause higher traveling resistance, shorter life of each part or generation of abnormal noise.

[Cleanroom specification RCS3(P) CR-SA8C]

How to inspect the interior:

- 1) Use an Allen wrench of 2 mm across flats to remove the two screws and turn up the stainless sheet.

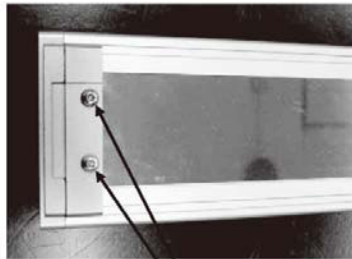

Stainless-sheet retainer cover mounting bolt



Make a visual check of the interior to see if there is any dust or foreign matter in the unit and check the lubrication. Even if the grease you see around the parts is brown, the lubrication is fine as long as the traveling surface appears shiny.

- 2) If the grease becomes dirty and dull or if the grease has worn away due to extended operating time, lubricate the parts after cleaning them.

- 3) Use an Allen wrench of 2 mm across flats to tighten the four screws to install the stainless sheet. The retainer cover is also affixing the side cover, so pay attention also to looseness of the side cover as you tighten the screws.

Tightening Torque: 74N · cm (7.52kgf · cm)

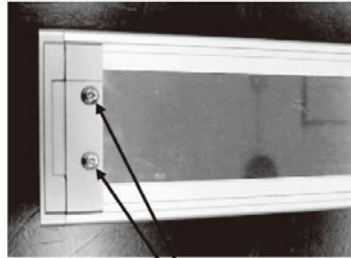

Stainless-sheet retainer cover mounting bolt



Caution: When checking the interior, be careful not to forcibly bend the screw cover or otherwise damage the cover.

The front cover is supporting the ball screw, so do not disassemble the cover. If a proper adjustment of the front cover is lost, misalignment of the center of axis may cause higher traveling resistance, shorter life of each part or generation of abnormal noise.

[RCS3 (P) -SS8C, Cleanroom specification RCS3(P)CR-SS8C]
How to inspect the interior:

- 1) Use an Allen wrench of 2 mm across flats to remove the two screws and turn up the stainless sheet.

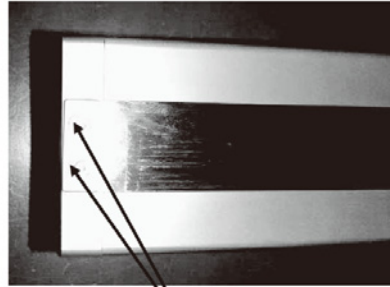

Stainless-sheet retainer cover mounting bolt

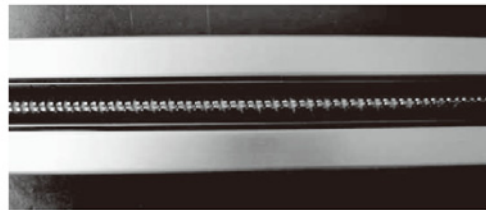

Make a visual check of the interior to see if there is any dust or foreign matter in the unit and check the lubrication. Even if the grease you see around the parts is brown, the lubrication is fine as long as the traveling surface appears shiny.

- 2) If the grease becomes dirty and dull or if the grease has worn away due to extended operating time, lubricate the parts after cleaning them.

3) Use an Allen wrench of 2 mm across flats to tighten the four screws to install the stainless sheet .

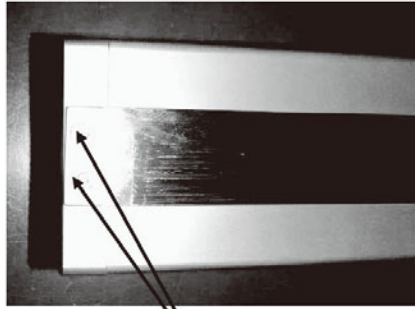

Stainless-sheet retainer cover mounting bolt



Caution: When checking the interior, be careful not to forcibly bend the screw cover or otherwise damage the cover.

The front cover is supporting the ball screw, so do not disassemble the cover.

If a proper adjustment of the front cover is lost, misalignment of the center of axis may cause higher traveling resistance, shorter life of each part or generation of abnormal noise.

11.6 Internal Cleaning

- Wipe off dirt with a soft cloth.
- Do not use strong compressed air on the actuator as this may force dust into the crevices.
- Do not use petroleum-based solvent, neutral detergent or alcohol.

Caution: Do not use flushing oil, molybdenum grease or anti-rust lubricant.
When grease is soiled with large amounts of foreign substances, wipe off the dirty grease and then apply new grease.

11.7 Adding Grease

11.7.1 Applicable Grease

[Other than Cleanroom Specification]

(1) What Grease to Use on the Guides

The following grease is used when we ship the unit.

Idemitsu Kosan	Daphne Eponex Grease No.2
----------------	---------------------------

Other companies also sell a grease similar to this. If ordering from another maker, give the name of this product and request something comparable. Comparable products include the following:

Showa Shell Oil	Albania Grease No. 2
Mobil Oil	Mobilux 2

(2) What Grease to Use on the Ball Screw

The following grease is used when we ship the unit.

This grease offers excellent properties such as low heat generation, and is suitable for lubricating ball screws.

Kyodo Yushi	Multemp LRL3
-------------	--------------

 Warning: Never use any fluorine-based grease. It will cause a chemical reaction when mixed with a lithium-based grease and may cause damage to the actuator.

[Cleanroom Specification]

(1) What grease to use on the guide and ball screw

The following grease is used when we ship the unit.
This grease is of low-dust-raising type.

Kuroda Precision Industries	C Grease
-----------------------------	----------

 **Warning:** Never use any fluorine-based grease and lithium-based grease. It will cause a chemical reaction when mixed with a urea based grease and may cause damage to the actuator.

 **Caution:** Never use grease for the standard specification. It may allow dust to generate.

11.7.2 How to Apply Grease to RCS2

- 1) When greasing the guide, use a spatula or grease applicator to squeeze or inject grease into the space between the slider and base, and then move the slider back and forth several times to let the grease spread evenly.

Apply grease on the guides on both sides.
Remove excess grease.

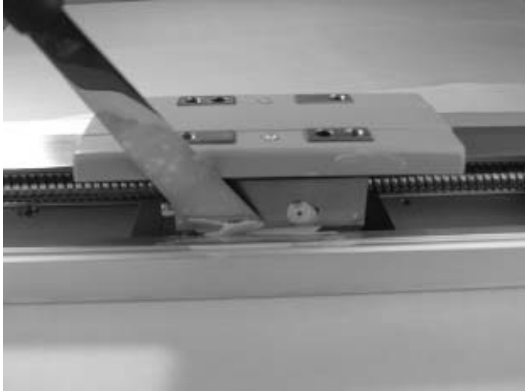

- 2) When greasing the ball screw, clean the ball screw, apply grease using a finger, and then move the slider back and forth several times to let the grease spread evenly.

At this time, be careful not to deform the stainless sheet by accidentally touching the sheet.
Remove excess grease.



- 3) Install the side covers.

Tightening torque: Thin-head screw M3 x 6 – 87.2 N·cm (8.90 kgf·cm)

Refer to 3) in 11.5 “Interior Inspection,” for notes on installing the side covers.



- Caution:**
- If the actuator is equipped with a microswitch (optional), carefully install the side covers so that the switch cables are not pinched.
 - In case the grease got into your eye, immediately go to see the doctor to get an appropriate care.
After finishing the grease supply work, wash your hands carefully with water and soap to rinse the grease OFF.

11.7.3 How to Apply Grease to the RCS3(P)(CR)

You can apply grease to the RCS3(P) (CR)-SA8 and RCS3 (P) (CR)-SS8 from outside the actuator without removing the exterior parts.

- For the RCS3 (P) (CR)-SA8, grease can be applied to the guide and ball screw from outside the actuator.
- For the RCS3 (P) (CR)-SS8, grease can be applied only to the guide from outside the actuator.

(1) How to apply grease to the guide (Common to RCS3 (P) (CR)-SA8 and SS8)

Remove the end face cover from the front bracket on the counter-motor side to expose grease nipples on the right and left. Use these grease nipples to apply grease.

- [1] Remove the end face cover.
- [2] Move the slider all the way to the end on the counter-motor side.
- [3] Insert a grease gun into the hole in the front bracket and add grease while keeping the slider in place.
 - * The right and left grease nipples are connected to different greasing circuits, respectively, so be sure to add grease into both nipples.
- [4] Move the slider back and forth several times by hand.
- [5] Repeat the above steps to apply grease.
- [6] Use a waste cloth, etc., to wipe off any grease that has overflowed from the slider.

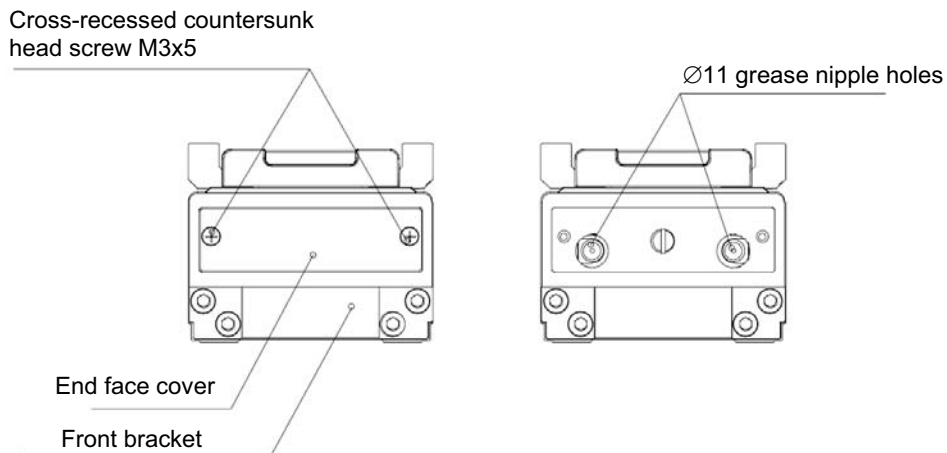

⚠ Caution: In case the grease got into your eye, immediately go to see the doctor to get an appropriate care. After finishing the grease supply work, wash your hands carefully with water and soap to rinse the grease OFF.

(2) How to apply grease to the ball screw

[RCS3(P) (CR)-SA8]

- [1] Use a grease gun to add grease into the grease nipple provided on the side face of the slider.
- [2] Move the slider back and forth several times by hand.
- [3] Repeat the above steps to apply grease.
- [4] Use a waste cloth, etc., to wipe off any grease that has overflowed from the slider.

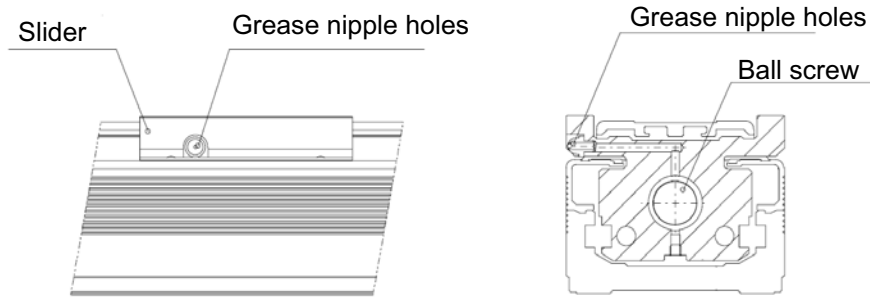

[RCS3(P) (CR)-SS8]

- 1) Turn up one side of the stainless sheet to expose the interior.
- 2) Clean the ball screw, apply grease by hand, and then move the slider back and forth to let the grease spread evenly.
Be careful not to let the ball screw contact, and deform, the stainless sheet.
Finally, wipe off any excess grease.



- 3) Install the stainless sheet.

Caution: In case the grease got into your eye, immediately go to see the doctor to get an appropriate care.
After finishing the grease supply work, wash your hands carefully with water and soap to rinse the grease OFF.

11.8 Replacing/Adjusting the Stainless Sheet

11.8.1 RCS2, RCS3(P)-SS8, RCS3(P)CR-SS8

[Items Required for Replacement]

- Replacement stainless sheet
- Clearance-checking tool (a regular slider cover with holes)
(This tool is available from IAI's Sales Engineering Section. If you are replacing the stainless sheet, please contact us to make a rental arrangement or purchase the tool.)
- Allen wrench set • Phillips screwdriver • Measure

[Note on Stainless Sheet Tension]

Deterioration and wear of the stainless sheet is affected by its tension.

If the stainless sheet is too tight, excessive clearances will be created between the sheet and slider covers and the sheet may undergo a fatigue failure.

If the stainless sheet is too loose, the sheet will contact the back of the slider covers and generate shaving. Therefore, use a dedicated adjustment tool to properly adjust the tension of the stainless sheet so that the clearances between the stainless sheet and slider covers conform to the specified dimension.

[Name of Each Part]

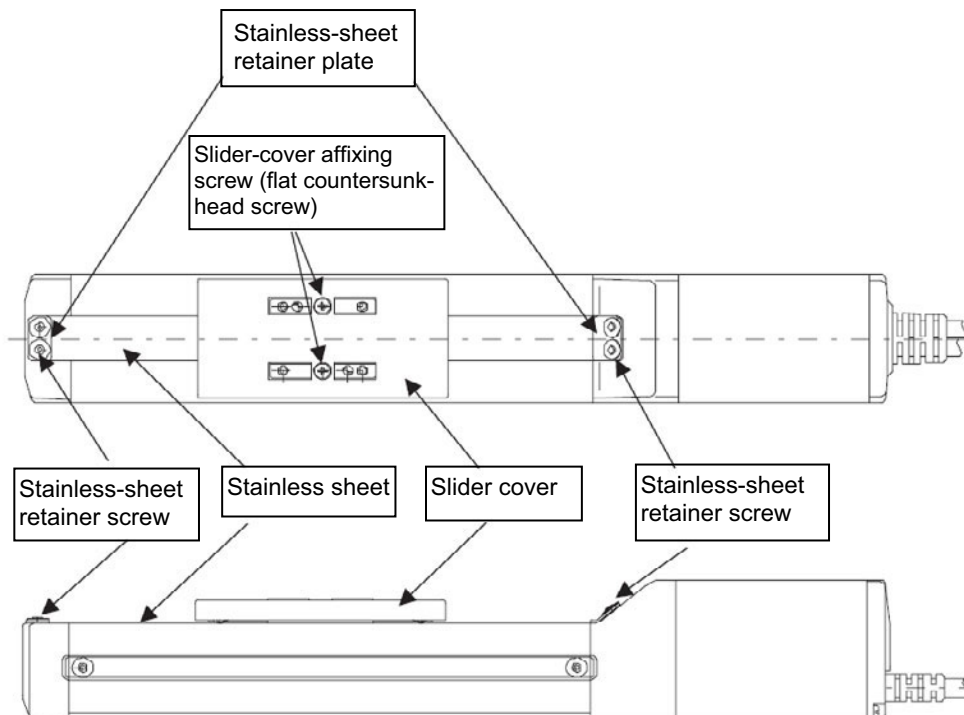

[Procedure]

- 1) Remove the slider-cover affixing screws and remove the covers.
After the slider covers have been removed

[1] Standard specification (slider structure)

- RCS2-SA4/SA5

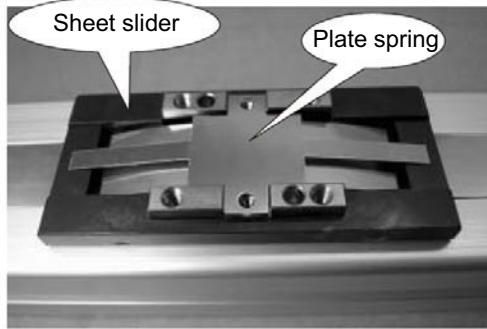

- RCS2-SA6/SA7/SS7/SS8

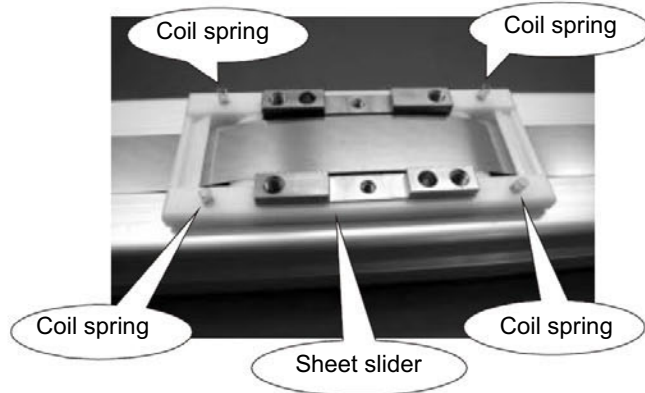

[2] Cleanroom specification, slider roller specification (option) (roller structure)

- RCS2CR-SA4/SA5/SA6/SA7/SS7/SS8

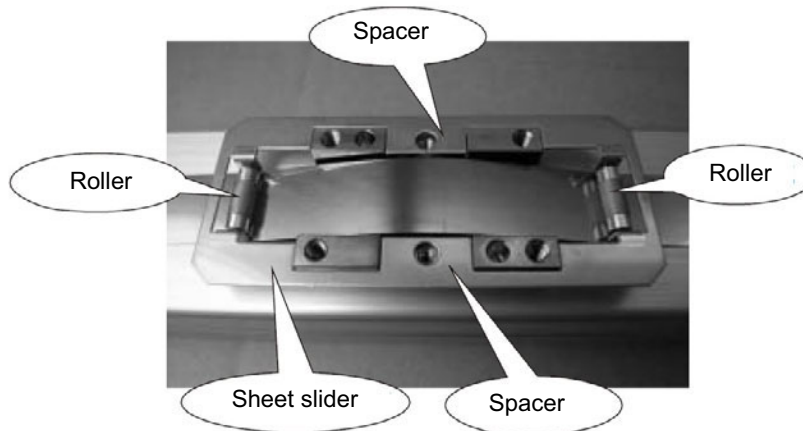

Caution: Remove the slider covers slowly and gently. If the actuator is installed on the ceiling or oriented vertically or horizontally on side, place a plastic bag, etc., underneath the slider covers so as not to lose the coil springs and spacers in case they drop off.

- 2) Remove the stainless-sheet retainer screws on both sides and pull out the stainless sheet.
- 3) Guide a new stainless sheet into the slider.
- 4) Hold the stainless sheet in place, and affix the retainer plates and screws.

At this time, securely tighten the screws only on the motor side, and leave the screws on the counter-motor side loose.

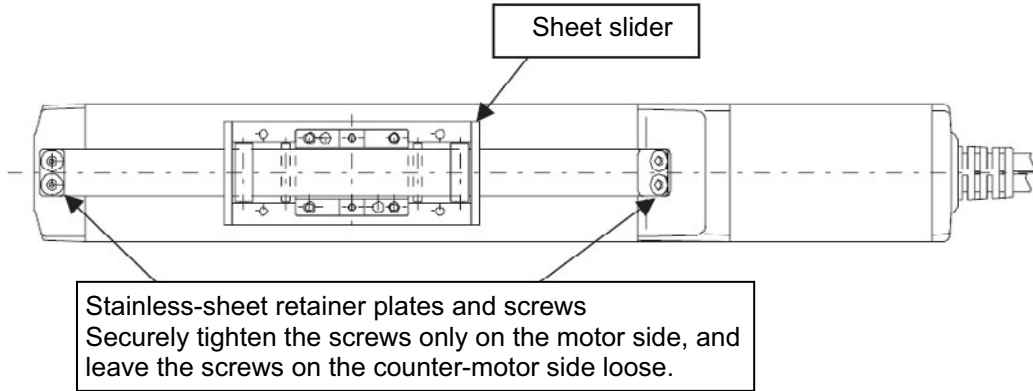

- How to prevent the stainless sheet from lifting

Slightly bend the stainless sheet downward near the center of the mounting holes so that the sheet can be held securely.

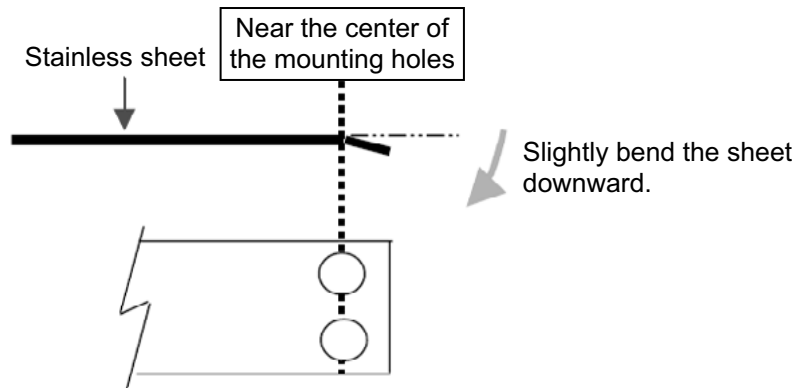

- 5) Install the clearance-checking tool.

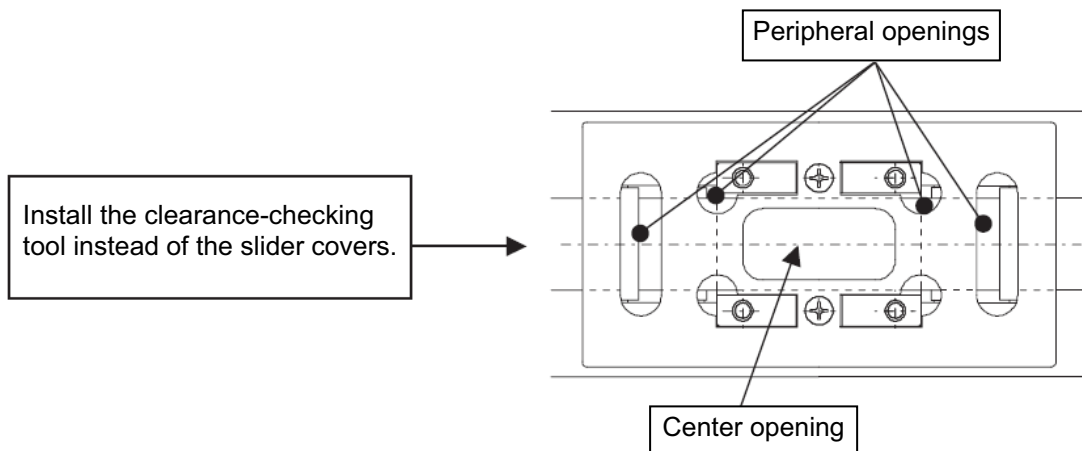

6) Adjust the tension of the stainless sheet.

- [1] While looking through the center opening in the clearance-checking tool, move the stainless sheet on the loose end in the directions of arrows until the clearance between the top face of the stainless sheet and the back of the clearance-checking tool falls within the specified range.

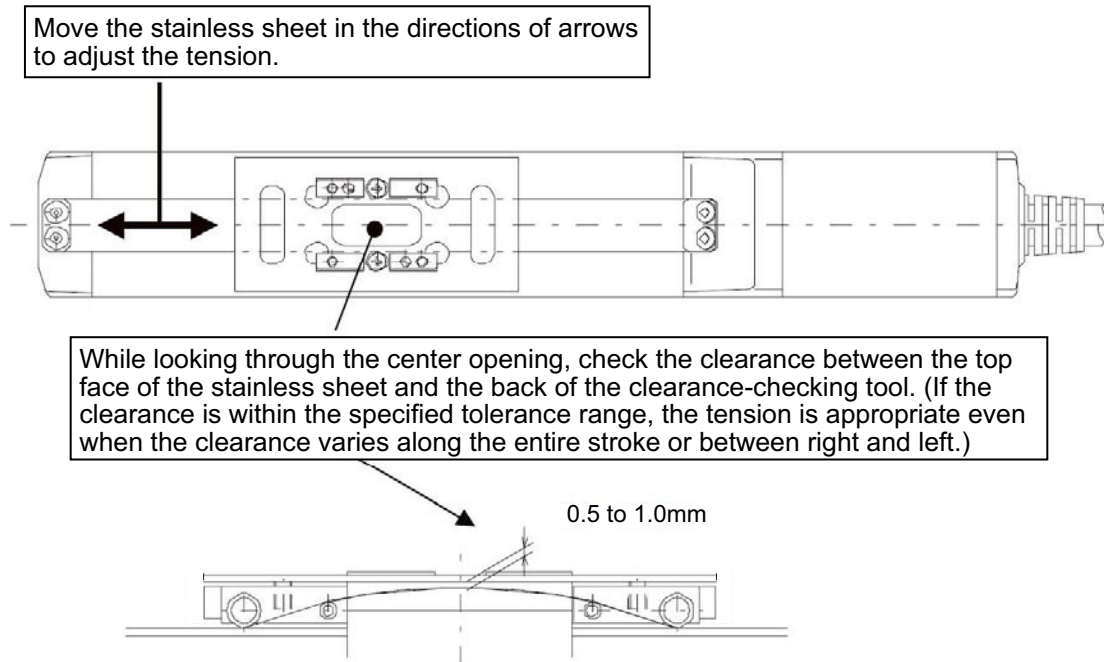

- [2] When the stainless sheet has been properly positioned, tighten the screws on the loose end to a level that the stainless sheet no longer moves.

[3] Move the slider and check the tension of the stainless sheet along the entire stroke.

Checkpoint 1:

Check if the clearance between the top face of the stainless sheet and the back of the clearance-checking tool falls within the specified range along the entire stroke.

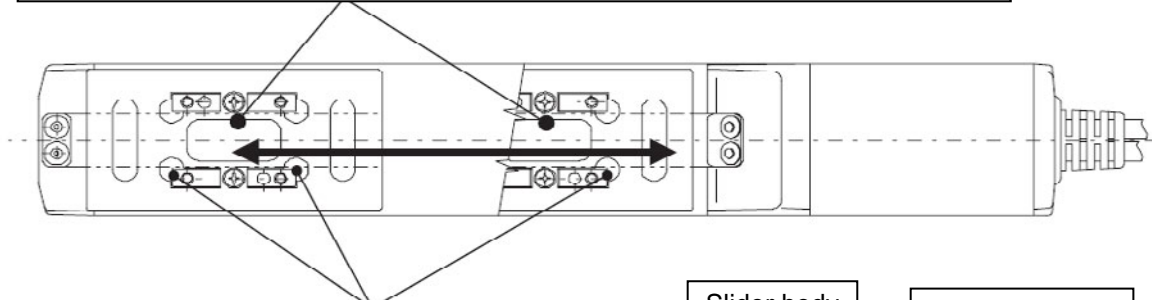

Checkpoint 2:

Look through the peripheral openings and confirm that the stainless sheet edges do not contact the slider body. Move the slider back and forth at least three times over the entire stroke to ensure the edges do not contact the slider. The sheet may move during the slider strokes, but slight movement is acceptable as long as the offset does not increase and the sheet does not contact the slider. If the stainless sheet contacts the slider, repeat the adjustment from [1].

The stainless sheet is not perfectly straight, but it bends to right and left slightly. It is impossible to adjust the right and left clearances perfectly uniform. Slight variation in clearance in the stroke direction or between right and left is acceptable, as long as the stainless sheet edges do not contact the slider body over the entire stroke.

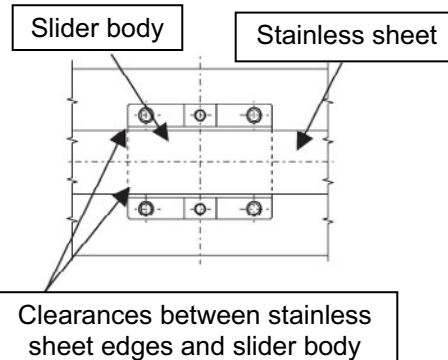

If the conditions in Checkpoints 1 and 2 are not satisfied, loosen the screws and readjust the position and tension of the stainless sheet again from [1].

Note) If the condition in Checkpoint 2 cannot be met after the readjustment, try installing the stainless sheet in the reverse direction or placing it upside down. If the stainless sheet is still not adjusted properly, replace it with a new sheet.

[4] When proper clearances are obtained between the slider body and stainless sheet and an absence of contact between the two is confirmed, tighten the two screws on the loose end alternately, and then finally tighten all screws to a uniform torque to securely affix the stainless sheet. If the screws are not tightened uniformly, the sheet may meander or lift.

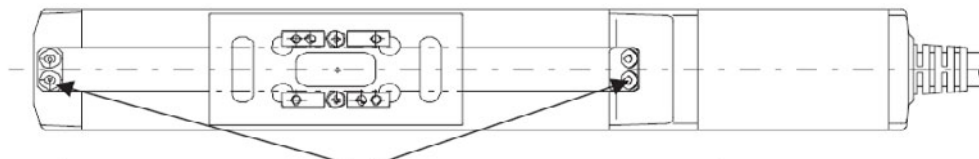

Apply additional torque to the screws on both ends until the stainless sheet no longer moves.
Tightening torque: 87.2 N·cm (8.90 kgf·cm) [Reference value]

[5] Remove the clearance-checking tool and install the slider covers.

Note) Again, pay attention not to lose the coil springs and spacers.

11.8.2 RCS3(P)CR-SA8C

[Items Required for Replacement]

- Replacement stainless sheet
- Allen wrench set
- Phillips screwdriver
- Measure

[Note on Stainless Sheet Tension]

Deterioration and wear of the stainless sheet is affected by its tension.

If the stainless sheet is too tight, excessive clearances will be created between the sheet and slider covers and the sheet may undergo a fatigue failure.

If the stainless sheet is too loose, the sheet will contact the back of the slider covers and generate shaving. Therefore, use a dedicated adjustment tool to properly adjust the tension of the stainless sheet so that the clearances between the stainless sheet and slider covers conform to the specified dimension.

[Name of Each Part]

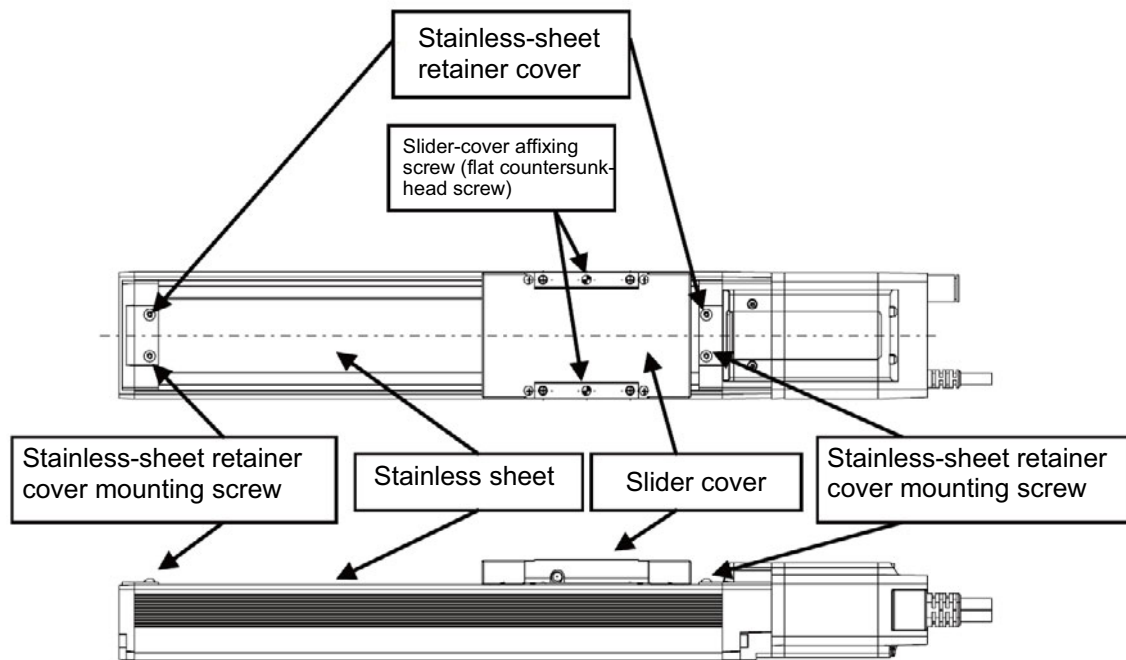

[Procedure]

- 1) Remove the slider-cover affixing screws and remove the covers.
After the slider covers have been removed

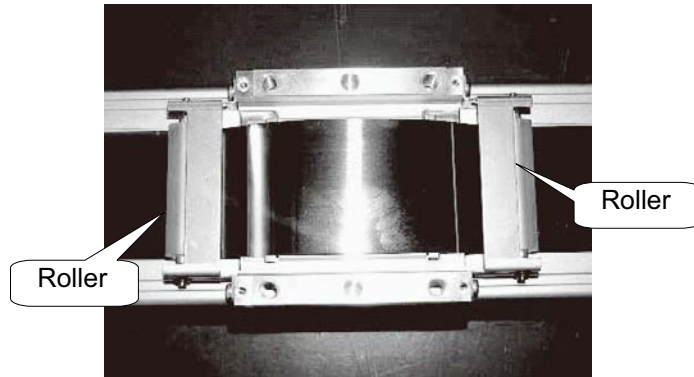

- 2) Remove the stainless-sheet retainer screws on both sides and pull out the stainless sheet.
- 3) Guide a new stainless sheet into the slider.
- 4) Hold the stainless sheet in place, and affix the retainer plates and screws.
At this time, securely tighten the screws only on the motor side, and leave the screws on the counter-motor side loose.

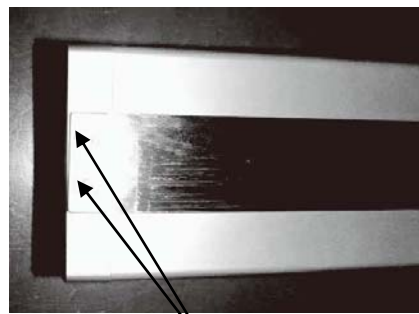

Stainless-sheet retainer cover mounting bolt

- How to prevent the stainless sheet from lifting
Slightly bend the stainless sheet downward near the center of the mounting holes so that the sheet can be held securely.

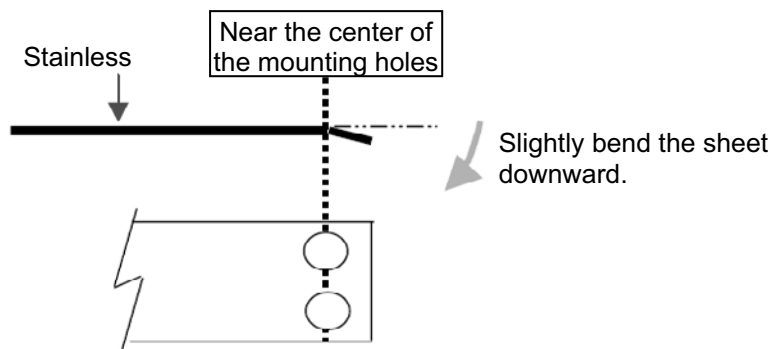

5) Adjust the tension of the stainless sheet.

[1] Pass a scale or other flat object over the front and rear roller assemblies and move the loosened side of the stainless sheet in the directions of the arrows until the clearance between the stainless sheet and scale becomes approx. 1 mm. Be sure to visually confirm that the stainless sheet is not contacting any location other than the rollers.

Move the stainless sheet in the directions of the arrows to adjust the tension.

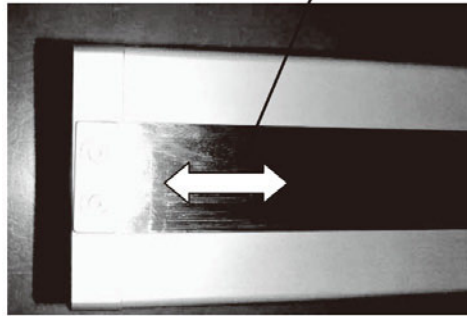

Make adjustment so that the clearance between the stainless sheet and scale becomes approx. 1 mm.

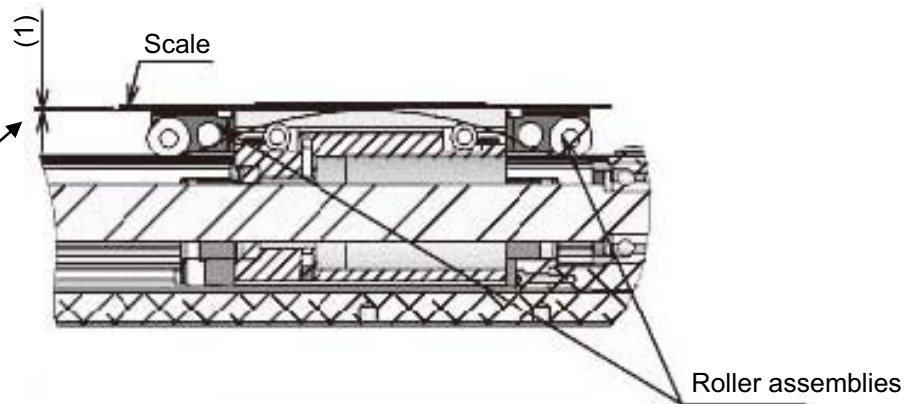

- [2] When the stainless sheet has been properly positioned, tighten the screws on the loose end to a level that the stainless sheet no longer moves.
- [3] Move the slider and check the tension of the stainless sheet along the entire stroke.

- [4] When proper clearances are obtained between the slider body and stainless sheet and an absence of contact between the two is confirmed, tighten the two screws on the loose end alternately, and then finally tighten all screws to a uniform torque to securely affix the stainless sheet. If the screws are not tightened uniformly, the sheet may meander or lift.

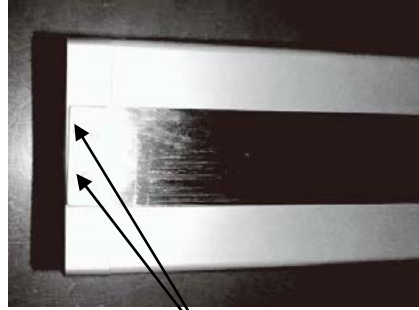

Stainless-sheet retainer cover mounting bolt

11.9 Reduction Belt [Motor Reversing Type]

11.9.1 Inspecting the Belt

Remove the pulley cover and visually inspect the belt.

Durability of the reduction belt is affected significantly by the operating condition, and there is no standard guideline as to when the belt should be replaced.

Generally, the belt is designed to withstand several millions of flexing loads.

As a practical guideline, replace the reduction belt when any of the conditions listed below is observed:

- The teeth and end faces of the belt have worn significantly.
- The belt has swollen due to deposits of oil, etc.
- Cracks and other damages are found on the teeth or back of the belt.
- The belt has broken.

11.9.2 Applicable Belt

- SA4 - 60S2M160R Rubber, cleanroom type (Bando Chemical Industries) 6 mm wide
- SA5 - 60S2M180R Rubber, cleanroom type (Bando Chemical Industries) 6 mm wide
- SA6 - 60S2M190R Rubber, cleanroom type (Bando Chemical Industries) 6 mm wide
- SA7 - 150S3M255U (Bando Chemical Industries) 15 mm wide
- SS7 - S3M222 (Bando Chemical Industries) 6 mm wide
- SS8 - P3M264 (Tsubakimoto Chain) 10 mm wide

11.9.3 Adjusting the Belt Tension (SA4R, SA5R, SA6R)

Remove the pulley cover and motor-end cover, and loosen the four motor affixing bolts.

Pass a looped strong string (or long tie-band) around the motor cover and pull it with a tension gauge to the specified tension. In this condition, uniformly tighten the motor-unit affixing bolts.

[Recommended tightening torque for adjustment bolts]

162 N·cm (16.5 kgf·cm)

Tension: 2.5 kgf



Motor-unit affixing bolts
(Use an Allen wrench of 2.5 mm across flats.)

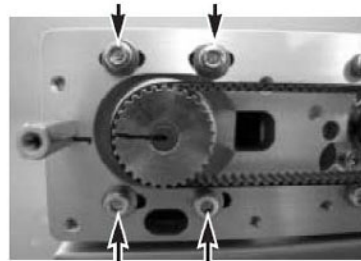

Motor-unit affixing bolts
(Use an Allen wrench of 2.5 mm across flats.)

11.9.4 Adjusting the Belt Tension (RCS2-SA7R)

Remove the pulley cover, loosen the four tension adjustment bolts, tension the belt by moving the motor to the left, and tighten the tension adjustment bolts.

[Recommended tightening torque for adjustment bolts]
(M4) 377 N · cm (38 kgf·cm)

Tension: 8 kgf ± 0.3 kgf



Tension adjustment bolts M4x20 (4 pcs)
Use an Allen wrench of 3 mm across flats.
Tightening torque 377 N·cm (38 kgf·cm)

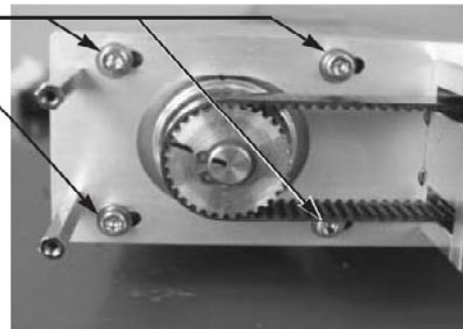

11.9.5 Adjusting the Belt Tension (RCS2-SS7R, SS8R)

Remove the pulley cover, loosen the four tension adjustment bolts, tension the belt by moving the motor to the left, and tighten the tension adjustment bolts.

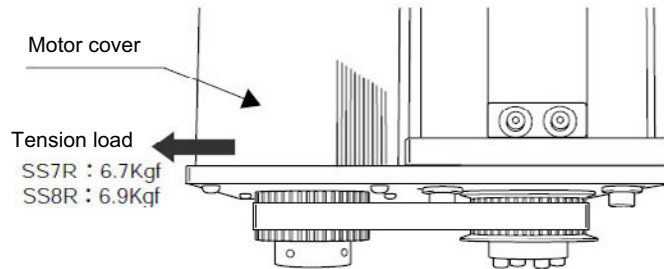

Tension adjustment bolts (2 pcs)
SS7R: Use an Allen wrench of 3 mm across flats.
Tightening torque 377 N·cm (38 kgf·cm)
SS8R: Use an Allen wrench of 4 mm across flats.
Tightening torque 763 N·cm (78 kgf·cm)

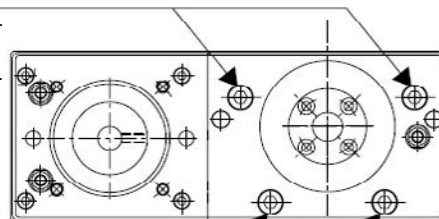

Tension adjustment bolts (2 pcs)
Use an Allen wrench of 3 mm across flats.
Tightening torque 377 N·cm (38 kgf·cm)

11.9.6 Replacing the Belt of the Motor Reversing Type (RCS2-SA4R, SA5R, SA6R)

[Items Required for Replacement]

- Replacement belt
- Allen wrenches
- Phillips screwdriver
- Tension gauge (capable of tensioning to 7 kgf or greater)
- Strong string, looped (or long tie-band)
- Scale
- Oil-based marker pen
- PC or teaching pendant

[Overview of Replacement]

- 1) Move the slider to a position where Z-phase turns on (home position) (2 mm from the mechanical end). In this position, loosen the motor-unit affixing bolts and replace the belt.
- 2) Restore the home position.
Affix the slider at a position 2 mm from the mechanical end on the home side, pass the belt, and adjust the belt to the specified tension.
- 3) Perform homing using a PC or teaching pendant and check for deviation from the initial home position.
If there is a deviation when the SCON controller is being used, use home return offset distance to make the adjustments. If the SSEL or the X-SEL controller is being used, use home preset value to make the adjustments.

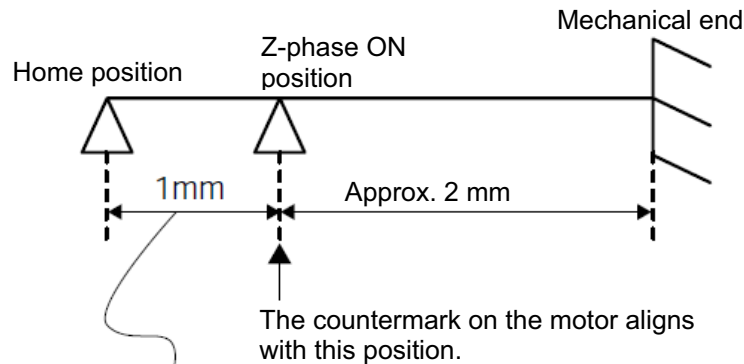

Use Parameter home return offset distance (SCON) or home preset value (SSEL and X-SEL) to specify the settings (The values displayed above are factory default settings).

[Procedure]

1) Remove the pulley cover using a Phillips screwdriver.

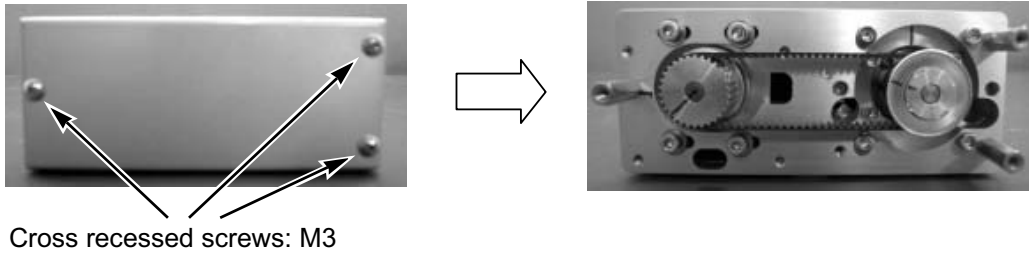

2) Use a Phillips screwdriver to remove the bolts affixing the motor-end cap and attached cables.

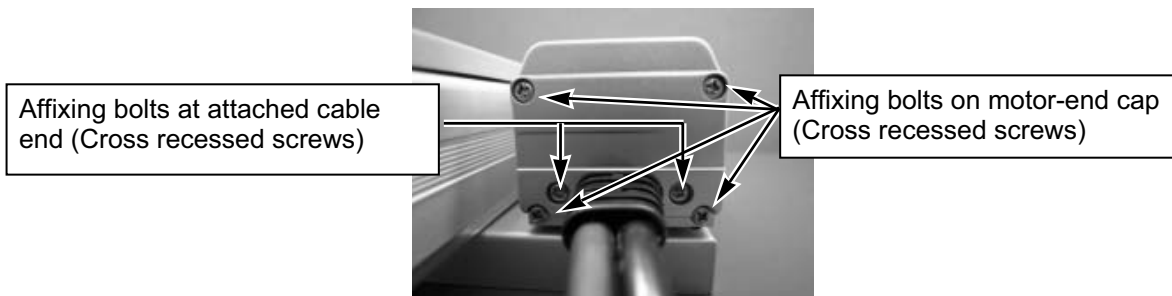

3) Pull out the motor-end cap.

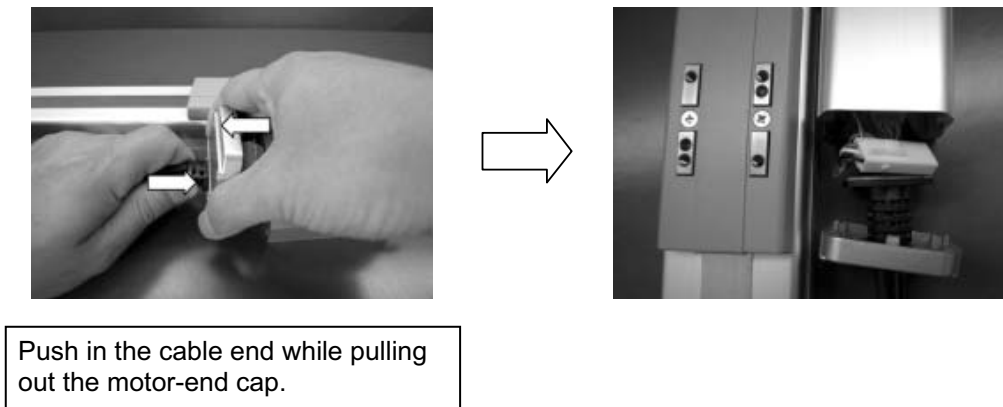

- 4) Pull out the motor-end cover to expose the motor.



- 5) Move the slider to a position where Z-phase turns on (home position).
On both standard actuators and actuators whose home is set on the opposite side, this position corresponds to 2 mm from the mechanical end.

Return the slider 2 mm from the mechanical end.

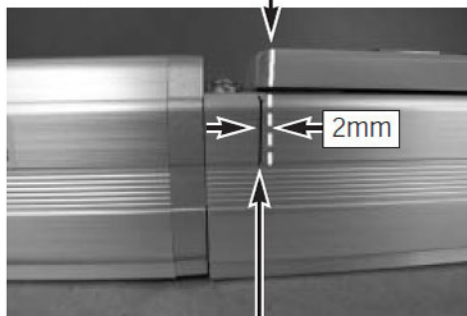

Draw a countermark with the slider contacting the mechanical end.

Return the slider 2 mm from the mechanical end.

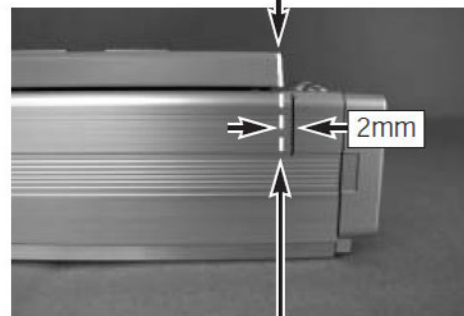

Draw a countermark with the slider contacting the mechanical end on the counter-motor side.

Warning: If the actuator is installed vertically, move it after turning on the controller power and forcibly releasing the brake. At this time, beware of danger as the actuator may drop suddenly.
Always provide a support to brace the actuator hand to prevent sudden drop, so as not to pinch fingers or damage the work part.

- 6) Loosen the motor-unit affixing bolts using an Allen wrench of 2.5 mm across flats. Slide the motor, and loosen and remove the belt.

Motor-unit affixing bolts
(Use an Allen wrench of 2.5 mm across flats.)

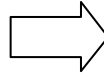
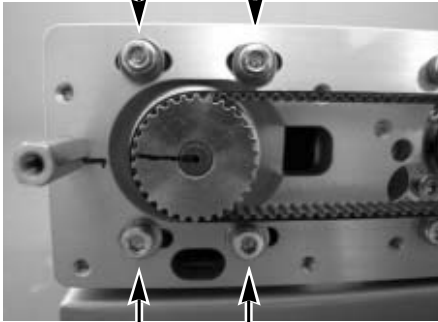

Motor-unit affixing bolts
(Use an Allen wrench of 2.5 mm across flats.)

- 7) Check the following points before restoring the home position:
- The motor side should be aligned with the initial countermark. If the position is offset, adjust it to achieve proper alignment.
 - The ball-screw side should be in a location corresponding to the slide position of 2 mm away from the mechanical end.

After the check, attach a new belt while holding the pulleys on both sides in position.

Initial countermark position

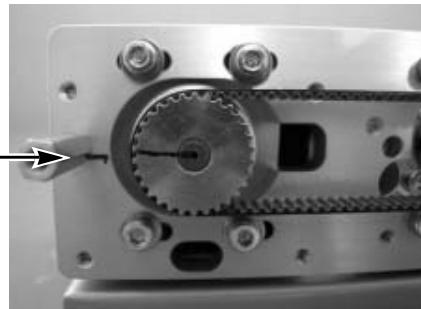

Motor side

Corresponding to the slider position of 2 mm away from the mechanical end

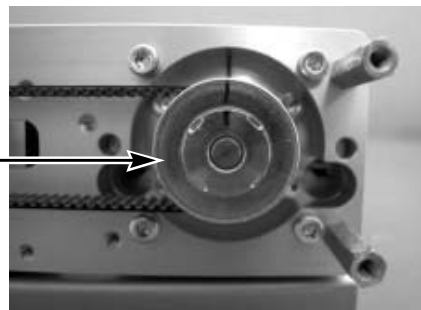

Ball-screw side

- 8) Adjust the belt tension.
Pass a looped strong string (or long tie-band) around the motor cover and pull it with a tension gauge to the specified tension. In this condition, uniformly tighten the motor-unit affixing bolts.

[Recommended tightening torque for adjustment bolts]
162 N·cm (16.5 kgf·cm)

Tension: 2.5 kgf



Motor-unit affixing bolts
(Use an Allen wrench of 2.5 mm across flats.)

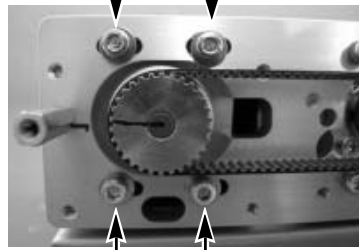

Motor-unit affixing bolts
(Use an Allen wrench of 2.5 mm across flats.)

- 9) Insert the motor-end cover and cap.



Pull out the cable end while pushing in the motor-end cap.

- 10) Use a Phillips screwdriver to securely tighten the affixing bolts for motor-end cap and attached cables.

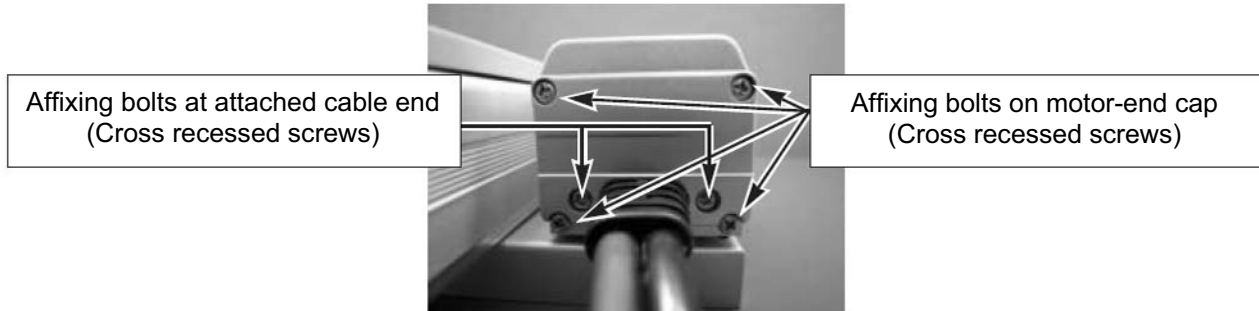

- 11) Use a Phillips screwdriver to securely tighten the affixing bolts for pulley cover.

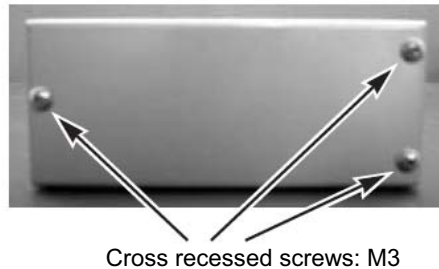

- 12) Connect a PC or teaching pendant to the controller to perform homing. (If the actuator is of absolute encoder specification, an absolute reset must be performed.)
Check for deviation from the initial home position.
If there is a deviation when the SCON controller is being used, use home return offset distance of parameter No. 22 to make corrections. If the SSEL or the X-SEL controller is being used, use home preset value of axis-specific parameter No. 12 to make corrections.
For the absolute encoder specification, perform homing → absolute reset after changing the parameter.

11.9.7 Replacing the Belt of the Motor Reversing Type (RCS2-SA7R)

[Items Required for Replacement]

- Replacement belt
- Allen wrenches
- Tension gauge (capable of tensioning to 8 kgf or greater)
- Strong string, looped (or long tie-band)
- PC or teaching pendant

[Overview of Replacement]

- 1) Loosen the tension adjustment bolts and replace the belt.
- 2) Restore the home position.
Press the slider against the mechanical end on the home side, and move the motor shaft away from the countermark by the specified distance. With the slider and motor shaft affixed in these positions, adjust the belt to the specified tension.
- 3) Perform homing using a PC or teaching pendant and check for deviation from the initial home position.
If there is a deviation when the SCON controller is being used, use home return offset distance to make the adjustments. If the SSEL or the X-SEL controller is being used, use home preset value to make the adjustments.

[Procedure]

- 1) Move the slider from the home position toward the mechanical end and check the rotating direction of the motor. (This check is necessary, because the rotating direction of the motor is different on actuators whose home is set on the opposite side.)
 - Remove the pulley cover.
(Remove the three thin-head mounting screws using an Allen wrench.)

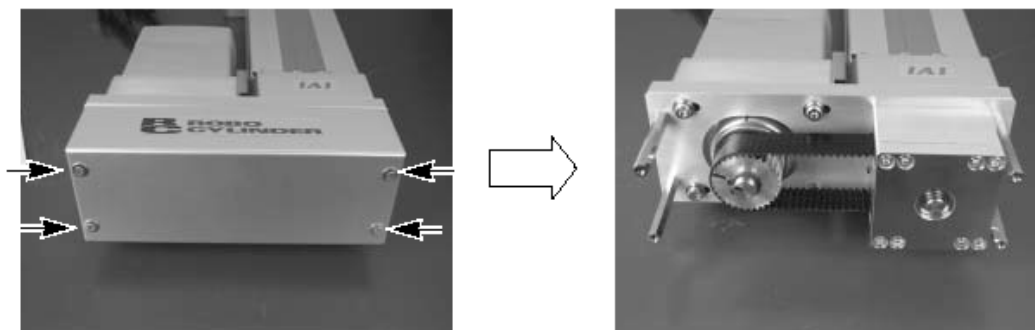

- 2) Loosen the four tension adjustment bolts and move the motor bracket to slack the belt.

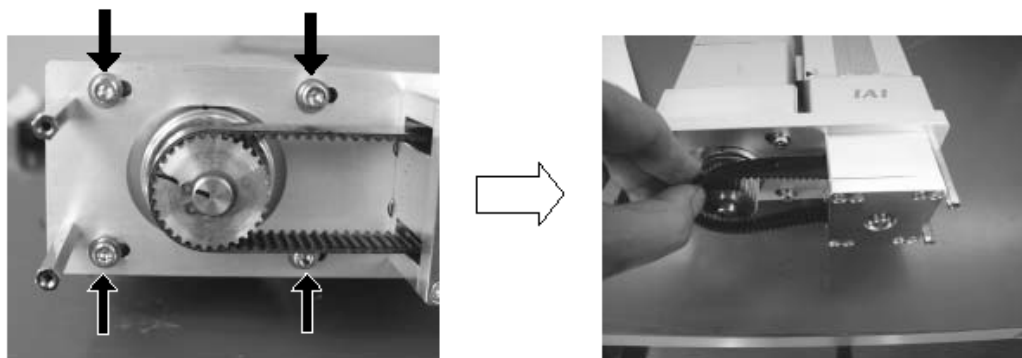

3) Remove the eight bolts affixing the pulley cap and pulley housing, and remove the belt.

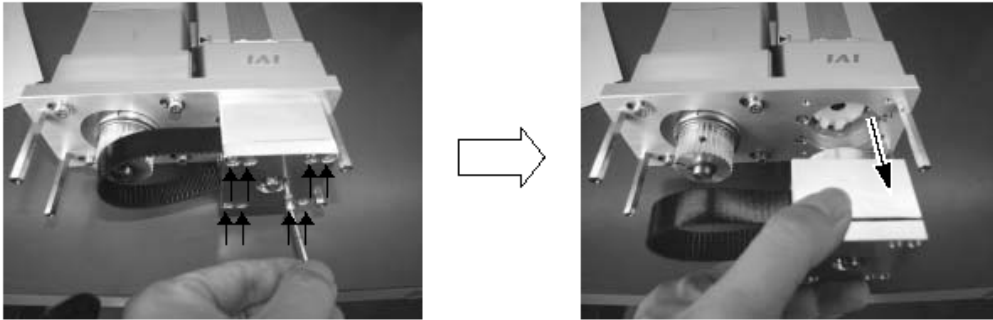

4) Install the pulley housing.
 (Install the pulley housing by making sure the angle of the projection on the coupling matches the angle of the mating hole.)

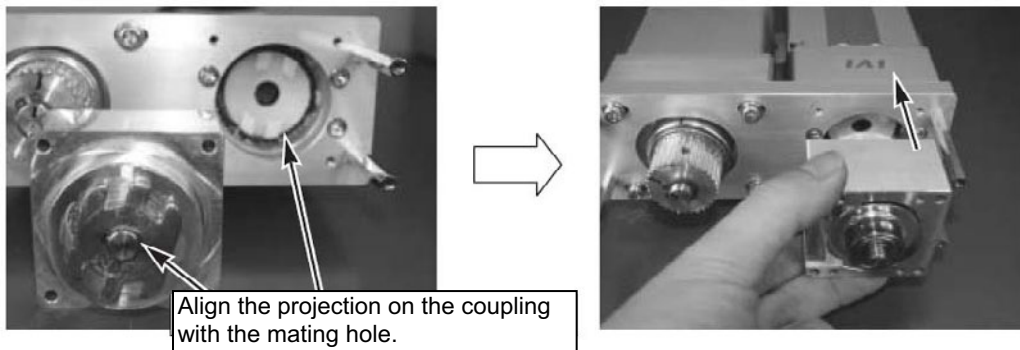

5) Make the adjustment to restore the home position.

- Press the slider against the mechanical end on the home side and affix the slider in this position.
- Turn the motor shaft away from the countermark by the specified distance in the direction of returning to the mechanical end (the direction checked earlier).

Example: When the return angle is 90 degrees →

Initial countermark position

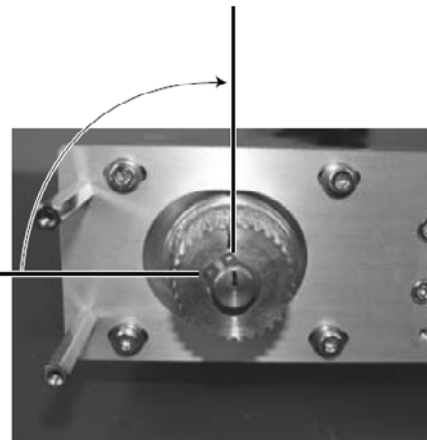

Type	Return angle from countermark position
SA7R-4	180 degrees
SA7R-8	90 degrees
SA7R-16	45 degrees

- 6) Adjust the belt tension.
Pass a looped strong string (or long tie-band) around the motor cover and pull it with a tension gauge to the specified tension. In this condition, uniformly tighten the adjustment bolts.

[Recommended tightening torque for adjustment bolts] (M4) 377 N·cm (38 kgf·cm)

Caution: Carefully tighten them to the specified torque by making sure the pulleys on both sides do not move.

Tension: $8 \text{ kgf} \pm 0.3 \text{ kgf}$

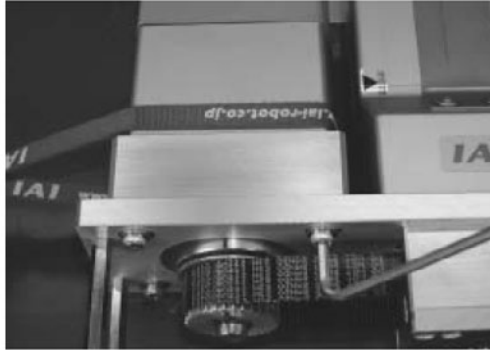

- 7) Install the pulley cover.
Tighten the four thin-head screws (M3x6) using an Allen wrench of 1.5 mm across flats.
- 8) Perform homing using a PC or teaching pendant.
(If the actuator is of absolute encoder specification, an absolute reset must be performed.)
Check for deviation from the initial home position.
If there is a deviation when the SCON controller is being used, use home return offset distance of parameter No. 22 to make corrections. If the SSEL or the X-SEL controller is being used, use home preset value of axis-specific parameter No. 12 to make corrections.
For the absolute encoder specification, perform homing → absolute reset after changing the parameter.

11.9.8 Replacing the Belt of the Motor Reversing Type (RCS2-SS7R, SS8R)

[Items Required for Replacement]

- Replacement belt
- Allen wrenches
- Tension gauge (capable of tensioning to 7 kgf or greater)
- Strong string, looped (or long tie-band)
- PC or teaching pendant

[Overview of Replacement]

- 1) Loosen the tension adjustment bolts and replace the belt.
- 2) Restore the home position.
Press the slider against the mechanical end on the home side, and move the motor shaft away from the countermark by the specified distance. With the slider and motor shaft affixed in these positions, adjust the belt to the specified tension.
- 3) Perform homing using a PC or teaching pendant and check for deviation from the initial home position. If there is a deviation, adjust the home offset parameter.
If there is a deviation when the SCON controller is being used, use home return offset distance to make the adjustments. If the SSEL or the X-SEL controller is being used, use home preset value to make the adjustments.

[Procedure]

- 1) Move the slider from the home position toward the mechanical end and check the rotating direction of the motor. (This check is necessary, because the rotating direction of the motor is different on actuators whose home is set on the opposite side.)
 - Remove the pulley cover.
(Remove the three thin-head mounting screws using an Allen wrench of 1.5 mm across flats for SS7R and of 2 mm across flats for SS8R.)
 - Check the rotating direction of the motor shaft.

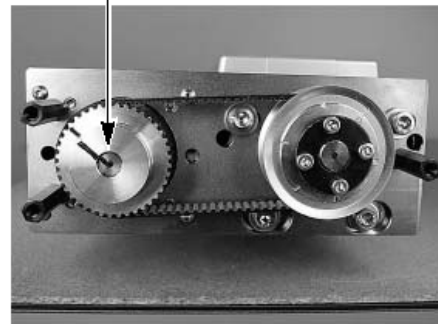

- 2) Loosen the tension adjustment bolts and move the motor bracket to slack and remove the belt.

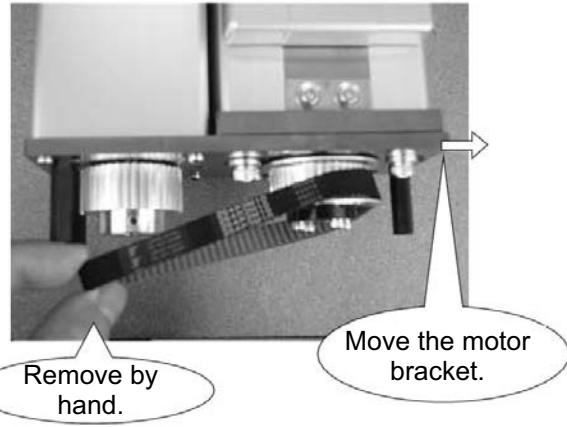
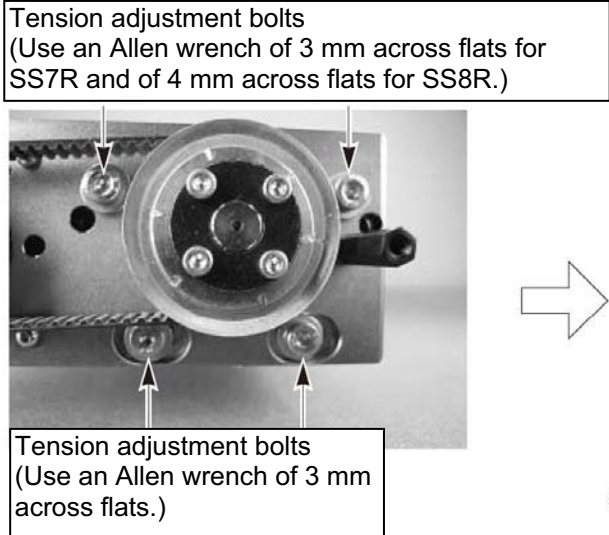

- 3) Make the adjustment to restore the home position.
- Press the slider against the mechanical end on the home side and affix the slider in this position.
 - Turn the motor shaft away from the countermark by the specified distance in the direction of returning to the mechanical end (the direction checked earlier).

Example for SS7R-12/SS8R-10 types:
Turn 90 degrees in the direction of returning to the mechanical end (standard home specification).

Initial countermark position

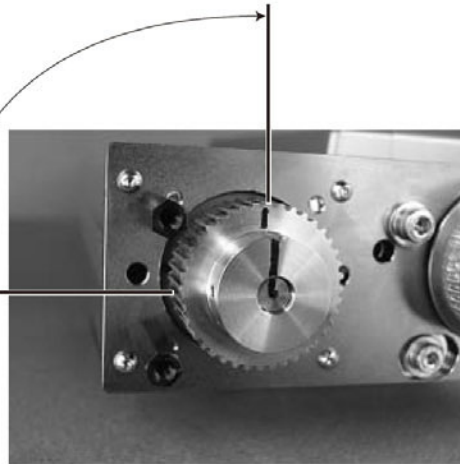

Type	Return angle from countermark position
SS7R-12 (high speed)	90 degrees
SS7R-6 (medium speed)	180 degrees
SS8R-20 (high speed)	45 degrees
SS8R-10 (medium speed)	90 degrees

- Pass the new belt by making sure the pulleys on both sides do not move.

4) Adjust the belt tension.

Pass a looped strong string (or long tie-band) around the motor cover and pull it with a tension gauge to the specified tension. In this condition, uniformly tighten the adjustment bolts.

Recommended tightening torque for adjustment bolts

SS7R: 2 upper bolts (M4) 377 N·cm (38 kgf·cm) SS8R: 2 upper bolts (M5) 763 N·cm (78 kgf·cm)
2 lower bolts (M4) 377 N·m (38 kgf·cm) 2 lower bolts (M4) 377 N·cm (38 kgf·cm)

Caution: Carefully tighten them to the specified torque by making sure the pulleys on both sides do not move.

Tension: SS7R: 6.7 kgf
SS8R: 6.9 kgf



5) Install the pulley cover.

With SS7R, tighten the three thin-head screws (M3x6) using an Allen wrench of 1.5 mm across flats. With SS8R, tighten the three thin-head screws (M4x6) using an Allen wrench of 2 mm across flats.

6) Perform homing using a PC or teaching pendant.

(If the actuator is of absolute encoder specification, an absolute reset must be performed.)

Check for deviation from the initial home position..

If there is a deviation when the SCON controller is being used, use home return offset distance of parameter No. 22 to make corrections. If the SSEL or the X-SEL controller is being used, use home preset value of axis-specific parameter No. 12 to make corrections.

For the absolute encoder specification, perform homing → absolute reset after changing the parameter.

11.10 Replacing the Motor

11.10.1 Replacing the Motor of the Motor Straight Type (Coupling Type) (Made by IAI) : RCS2-SA4C, SA5C, SA6C

[Items Required for Replacement]

- Replacement motor
- Coupling (with screws)
- Allen wrenches
- Phillips screwdriver
- Scale
- Oil-based marker pen
- Grease

Other than cleanroom specification

Idemitsu Kosan	Daphne Eponex Grease No.2
----------------	---------------------------

Cleanroom specification

Kuroda Precision Industries	C Grease
-----------------------------	----------

- PC or teaching pendant

Example: Replacement motor (IAI encoder)

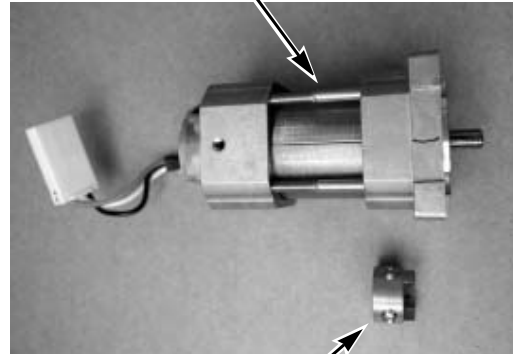

Coupling (with screws)



Caution: When replacing the motor, handle the replacement motor with due care. The actuator has been shipped with the encode adjusted to an optimal position, so do not crush the encoder unit. It may displace the encoder, thus impairing proper actuator operation.

[Overview of Replacement]

- 1) Move the slider to a position where Z-phase turns on (home position) (2 mm from the mechanical end). Replace the motor in this position.
- 2) Perform homing using a PC or teaching pendant and check for deviation from the initial home position. If there is a deviation when the SCON controller is being used, use home return offset distance to make the adjustments. If the SSEL or the X-SEL controller is being used, use home preset value to make the adjustments.

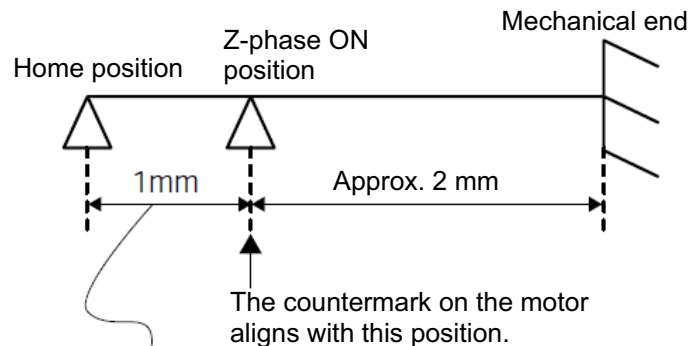

Use Parameter home return offset distance (SCON) or home preset value (SSEL and X-SEL) to specify the settings (The values displayed above are factory default settings).

[Procedure]

- 1) Move the slider to a position where Z-phase turns on (home position).
On both standard actuators and actuators whose home is set on the opposite side, this position corresponds to 2 mm from the mechanical end.

Return the slider 2 mm from the mechanical end.

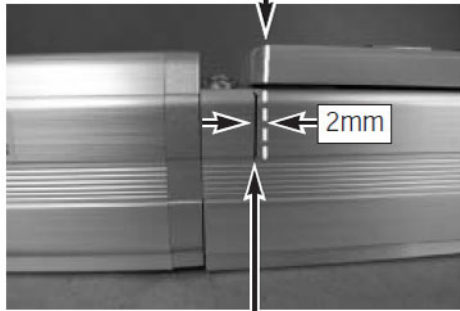

Draw a countermark with the slider contacting the mechanical end.

Return the slider 2 mm from the mechanical end.

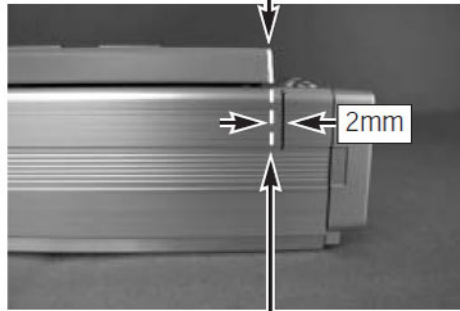

Draw a countermark with the slider contacting the mechanical end on the counter-motor side.

Warning: If the actuator is installed vertically, move it after turning on the controller power and forcibly releasing the brake. At this time, beware of danger as the actuator may drop suddenly. Always provide a support to brace the actuator hand to prevent sudden drop, so as not to pinch fingers or damage the work part.

- 2) Use a Phillips screwdriver to securely tighten the affixing bolts for motor-end cap and attached cables.

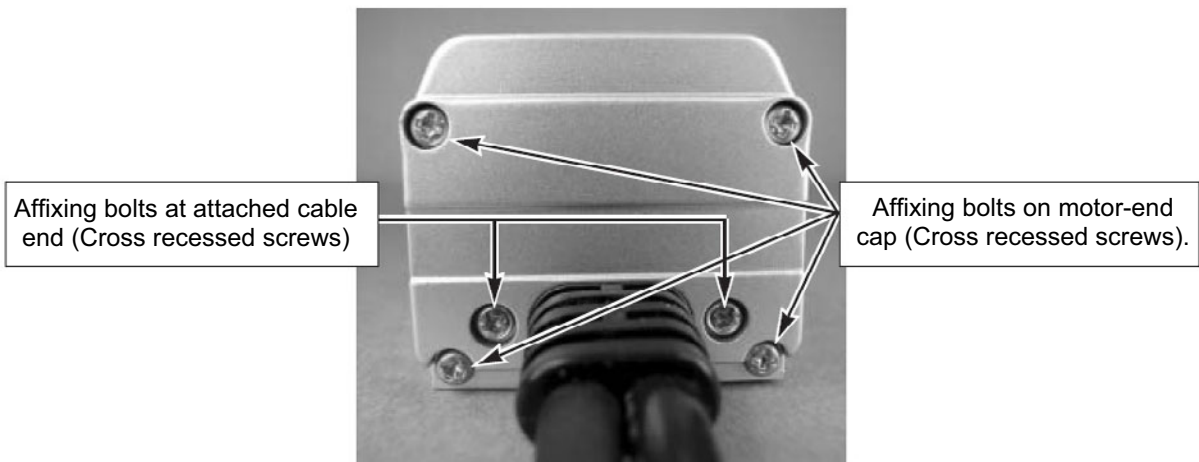

3) Pull out the motor-end cap.

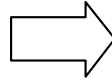

Push in the cable end while pulling out the motor-end cap.

4) Pull out the motor-end cover to expose the motor.



- 5) Detach the attached cables.
- Pull out the motor connector.



- If the actuator has a brake, also detach the brake connector.
- Remove the grounding wire using a Phillips screwdriver.



- While holding the motor with one hand, pull out the encoder cable. (The photograph bellow shows the motor (Encoder by IAI).)



6) Detach the attached cables.



7) Take out the motor.

- Remove the two motor affixing bolts using an Allen wrench of 2.5 mm across flats.

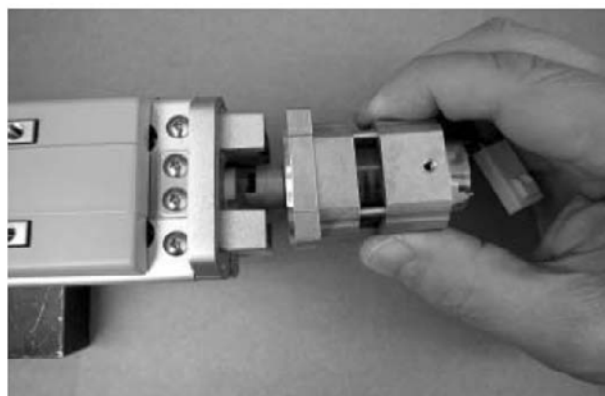
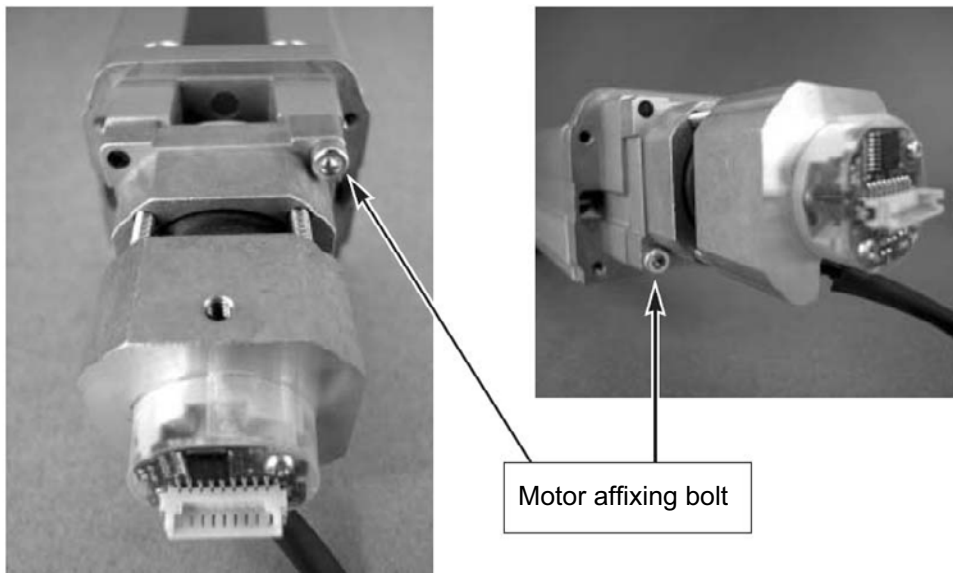

8) Apply grease on the actuator coupling.

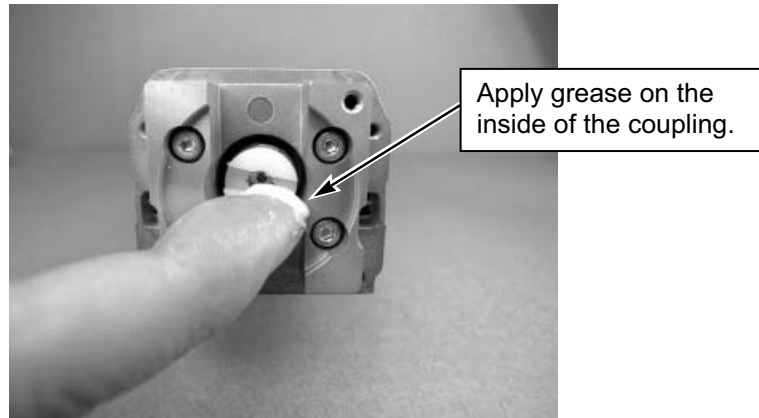

9) Insert the replacement coupling (with screws) by aligning it with the current orientation of the actuator coupling.

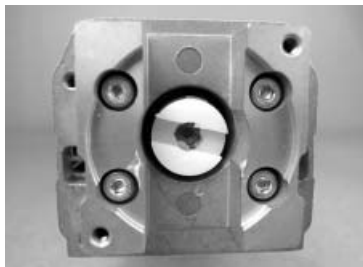

Coupling on actuator side

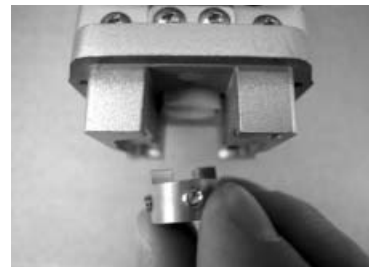

Inserting the coupling (with screws)



Inserted coupling (with screws)

10) Mark the shaft and body of the replacement motor to prevent the motor shaft position from deviating.

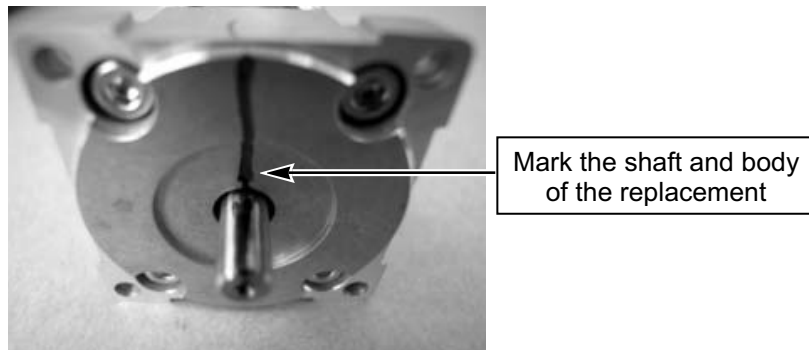

11) Insert the replacement motor into the actuator coupling, and secure with two motor affixing bolts.

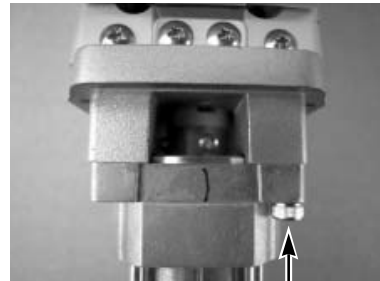

- 12) Tighten the screw on the coupling.

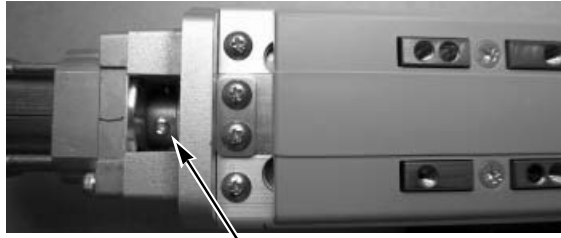

Tighten the screw on the coupling using an Allen wrench of 2.0 mm across flats.

- 13) Slightly move the slider to expose the second screw on the coupling, and tighten the screw in the same manner.

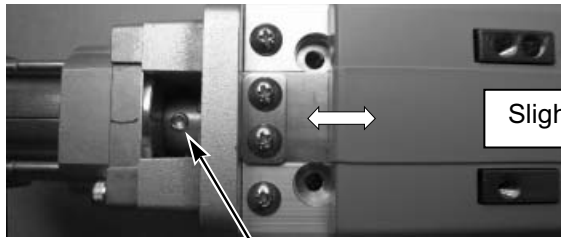

Slightly move the slider.

Tighten the screw on the coupling using an Allen wrench of 2.0 mm across flats.

- 14) Install the attached cables.
- While holding the motor with one hand, insert the encoder cable.
(The photograph bellow shows the motor (Encoder by IAI).)



- Install a grounding wire using a Phillips driver.



- Plug the cables into the motor.

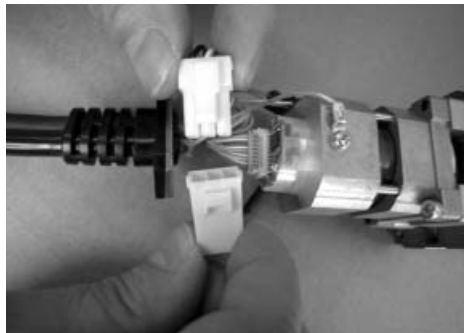

- 15) Insert the motor-end cover and cap.
Store the connector inside the motor-end cap.

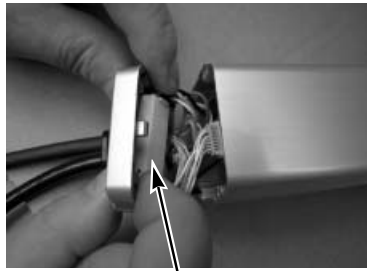

Store the connector inside the motor-end cap.



Pull out the cable end while pushing in the motor-end cap.

- 16) Use a Phillips screwdriver to securely tighten the affixing bolts for motor-end cap and attached cables.

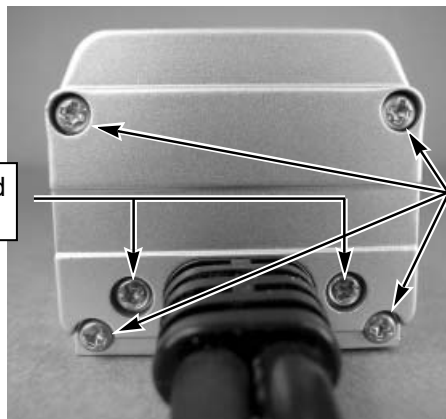

Affixing bolts at attached cable end
(Cross recessed screws)

Affixing bolts on motor-end cap
(Cross recessed screws).

- 17) Connect a PC or teaching pendant to the controller to perform homing. (If the actuator is of absolute encoder specification, an absolute reset must be performed.)
Check for deviation from the initial home position.
If there is a deviation when the SCON controller is being used, use home return offset distance of parameter No. 22 to make corrections. If the SSEL or the X-SEL controller is being used, use home preset value of axis-specific parameter No. 12 to make corrections.
For the absolute encoder specification, perform homing → absolute reset after changing the parameter.

11.10.2 Replacing the Motor of the Motor Straight Type (Coupling Type) (Not Made by IAI) : RCS2-SA4C, SA5C, SA6C

[Items Required for Replacement]

- Replacement motor
- Grease
- Actuator cable
- Coupling (with screws)
- Allen wrenches
- Phillips screwdriver
- Scale
- Oil-based marker pen

Other than cleanroom specification

Idemitsu Kosan	Daphne Eponex Grease No.2
----------------	---------------------------

Cleanroom specification

Kuroda Precision Industries	C Grease
-----------------------------	----------

- PC or teaching pendant

Example:
Replacement motor (Encoder by Tamagawa Motor)

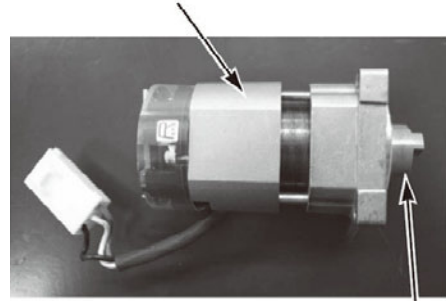

Coupling (with screws)

Actuator cable



Caution: When replacing the motor, handle the replacement motor with due care. The actuator has been shipped with the encode adjusted to an optimal position, so do not crush the encoder unit. It may displace the encoder, thus impairing proper actuator operation.

[Overview of Replacement]

- 1) Move the slider to a position where Z-phase turns on (home position) (2 mm from the mechanical end). Replace the motor in this position.
- 2) Perform homing using a PC or teaching pendant and check for deviation from the initial home position. If there is a deviation when the SCON controller is being used, use home return offset distance to make the adjustments. If the SSEL or the X-SEL controller is being used, use home preset value to make the adjustments.

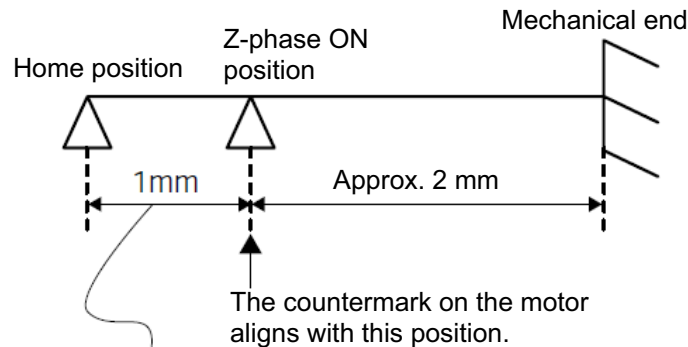

Use Parameter home return offset distance (SCON) or home preset value (SSEL and X-SEL) to specify the settings (The values displayed above are factory default settings).

[Procedure]

- 1) Move the slider to a position where Z-phase turns on (home position).
On both standard actuators and actuators whose home is set on the opposite side, this position corresponds to 2 mm from the mechanical end.

Return the slider 2 mm from the mechanical end.

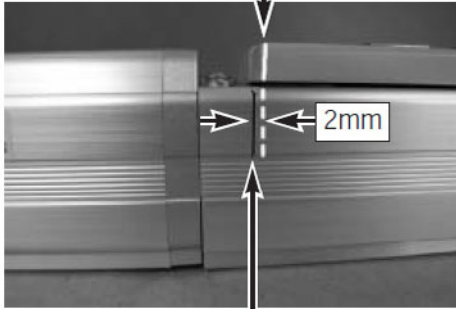

Draw a countermark with the slider contacting the mechanical end.

Return the slider 2 mm from the mechanical end.

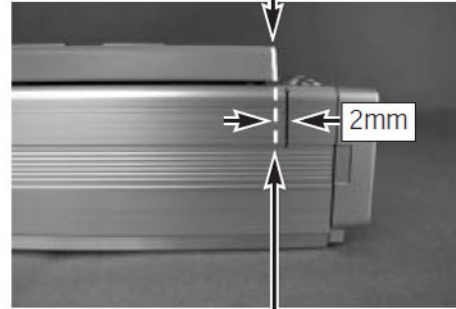

Draw a countermark with the slider contacting the mechanical end on the counter-motor side.

Warning: If the actuator is installed vertically, move it after turning on the controller power and forcibly releasing the brake. At this time, beware of danger as the actuator may drop suddenly. Always provide a support to brace the actuator hand to prevent sudden drop, so as not to pinch fingers or damage the work part.

- 2) Use a Phillips screwdriver to securely tighten the affixing bolts for motor-end cap and actuator cables.

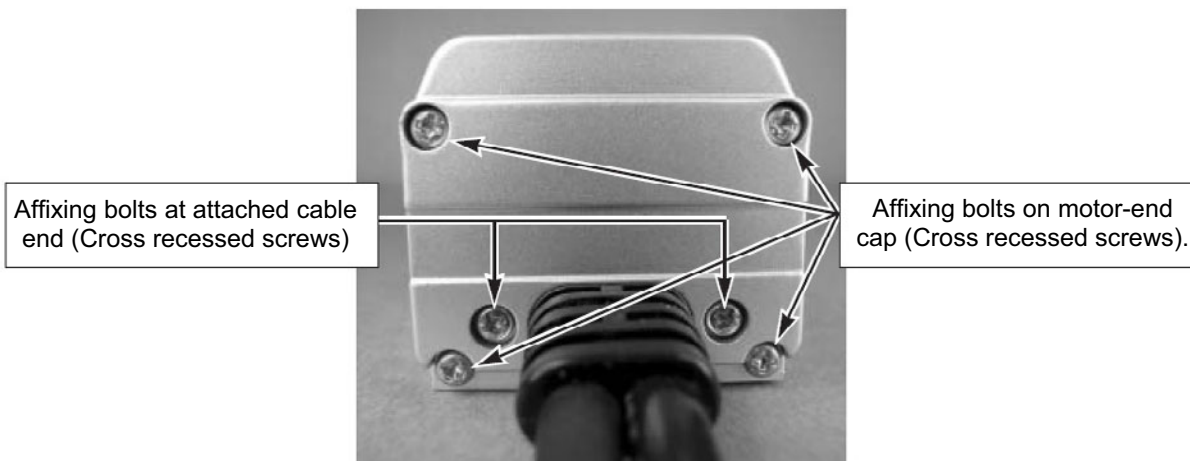

3) Pull out the motor-end cap.

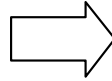

Push in the cable end while pulling out the motor-end cap.

4) Pull out the motor-end cover to expose the motor.

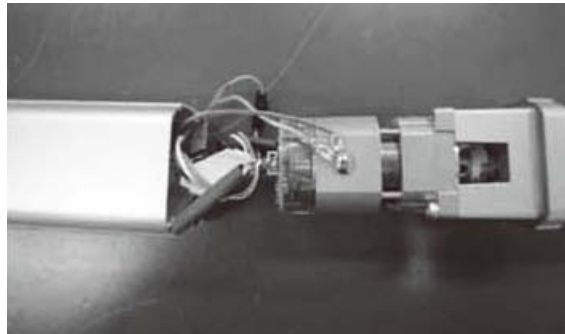

- 5) Detach the actuator cables.
- Pull out the motor connector.

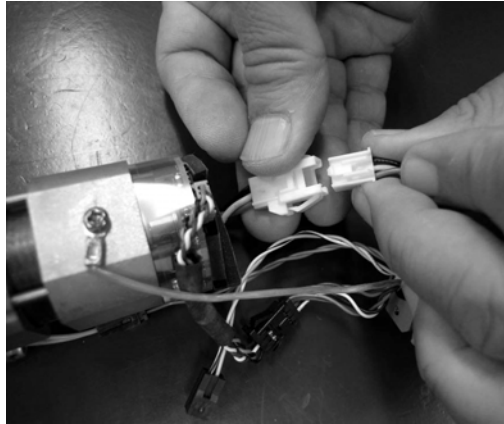

- If the actuator has a brake, also detach the brake connector.
- Remove the grounding wire using a Phillips screwdriver.



- While holding the motor with one hand, pull out the encoder cable. (The photograph bellow shows the motor (Encoder by IAI).)



6) Disconnect the encoder relay cable from the actuator cable.

The encoder relay cable will be attached to the actuator cable for replacement in Step 17).

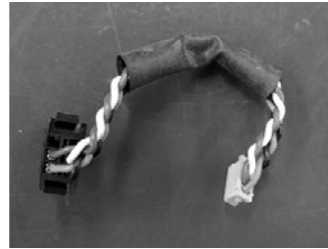
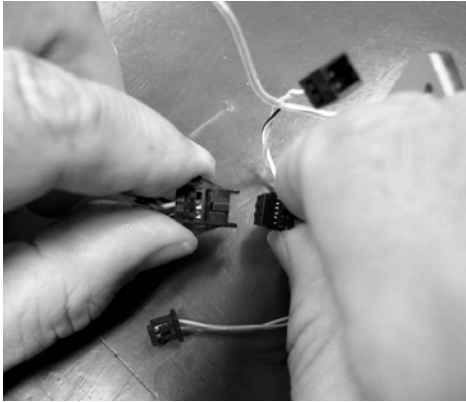

Encoder Relay Cable

7) Detach the motor cover from the actuator cable.

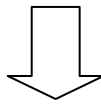
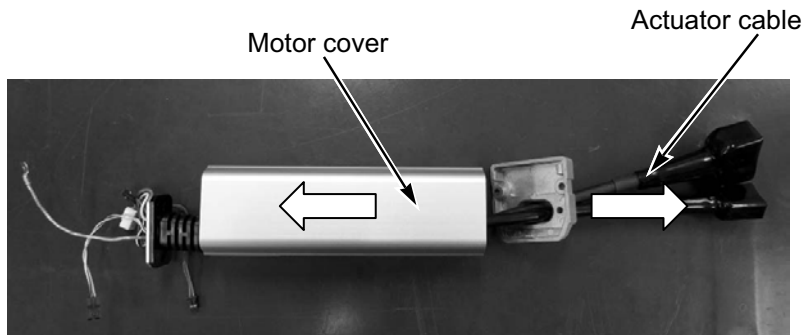

8) Take out the motor.

- Remove the two motor affixing bolts using an Allen wrench of 2.5 mm across flats.

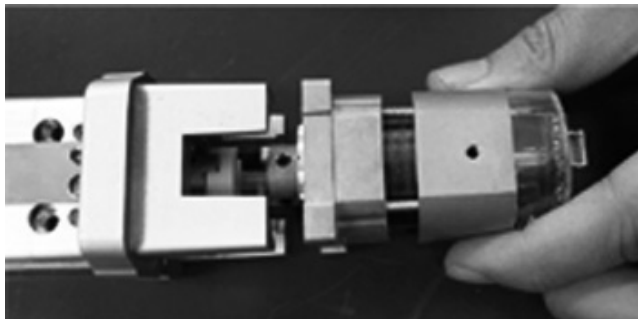
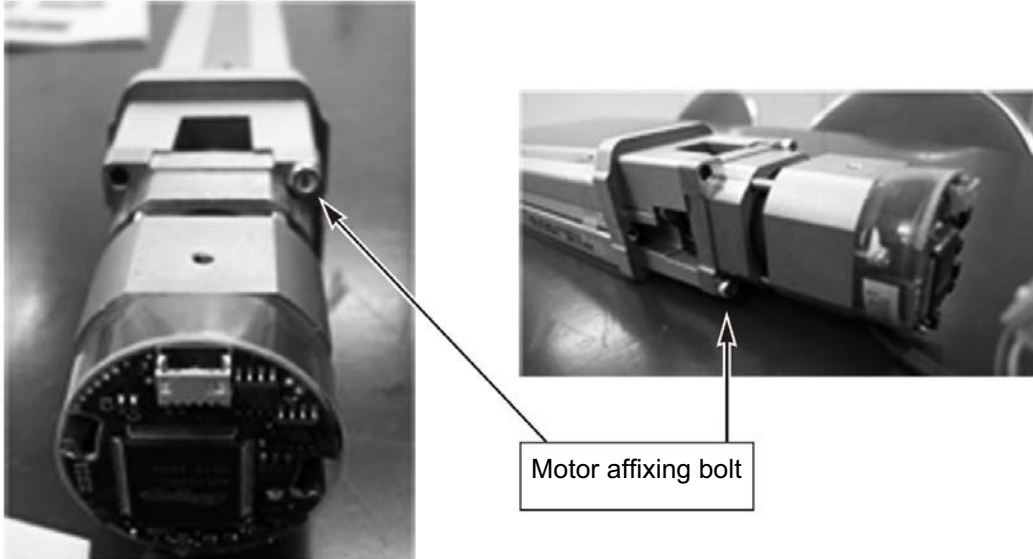

9) Apply grease on the actuator coupling.

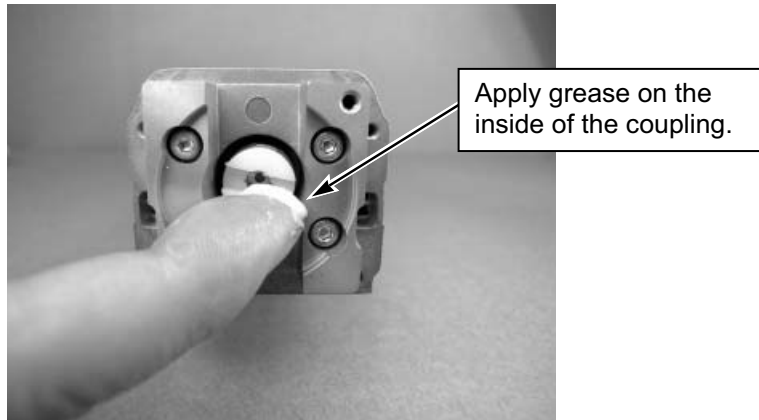

10) Insert the replacement coupling (with screws) by aligning it with the current orientation of the actuator coupling.

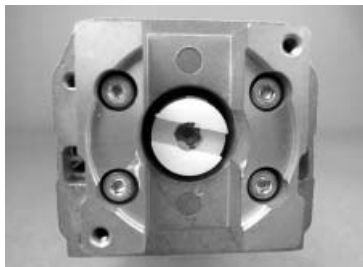

Coupling on actuator side



Inserting the coupling (with screws)



Inserted coupling (with screws)

- 11) Mark the shaft and body of the replacement motor to prevent the motor shaft position from deviating.

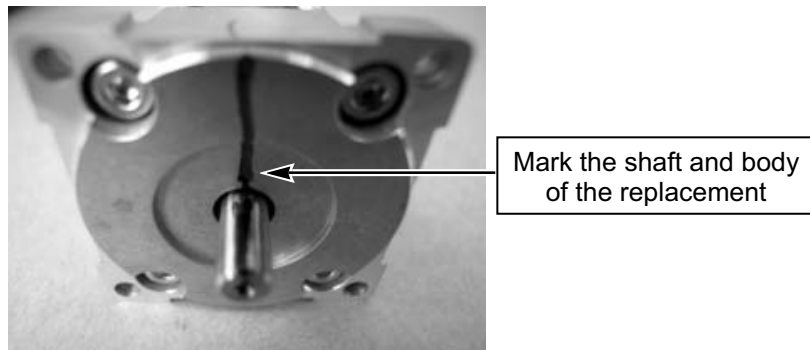

- 12) Insert the replacement motor into the actuator coupling, and secure with two motor affixing bolts.

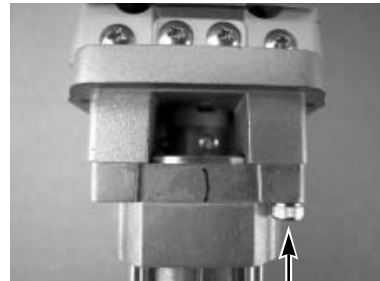

13) Tighten the screw on the coupling.

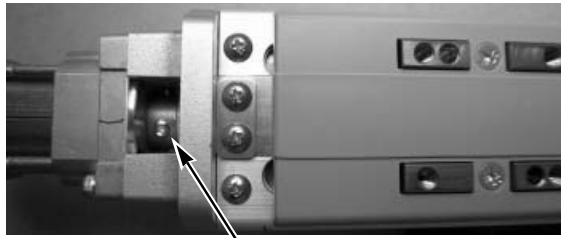

Tighten the screw on the coupling using an Allen wrench of 2.0 mm across flats.

14) Slightly move the slider to expose the second screw on the coupling, and tighten the screw in the same manner.

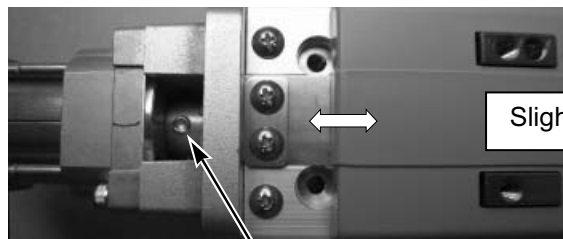

Slightly move the slider.

Tighten the screw on the coupling using an Allen wrench of 2.0 mm across flats.

15) Detach the screws on the end cap in the actuator cable for replacement with a phillips screwdriver.

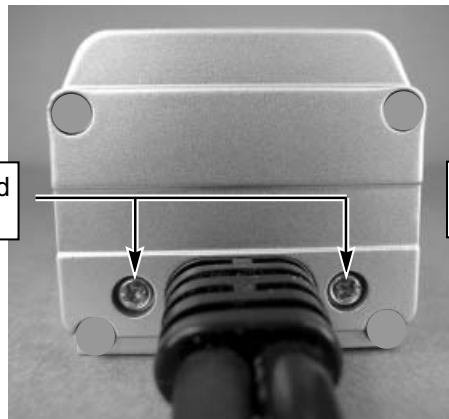

Affixing bolts at attached cable end
(Cross recessed screws)

Affixing bolts on motor-end cap
(Cross recessed screws).

16) Attach the motor cover on the actuator cable for replacement.

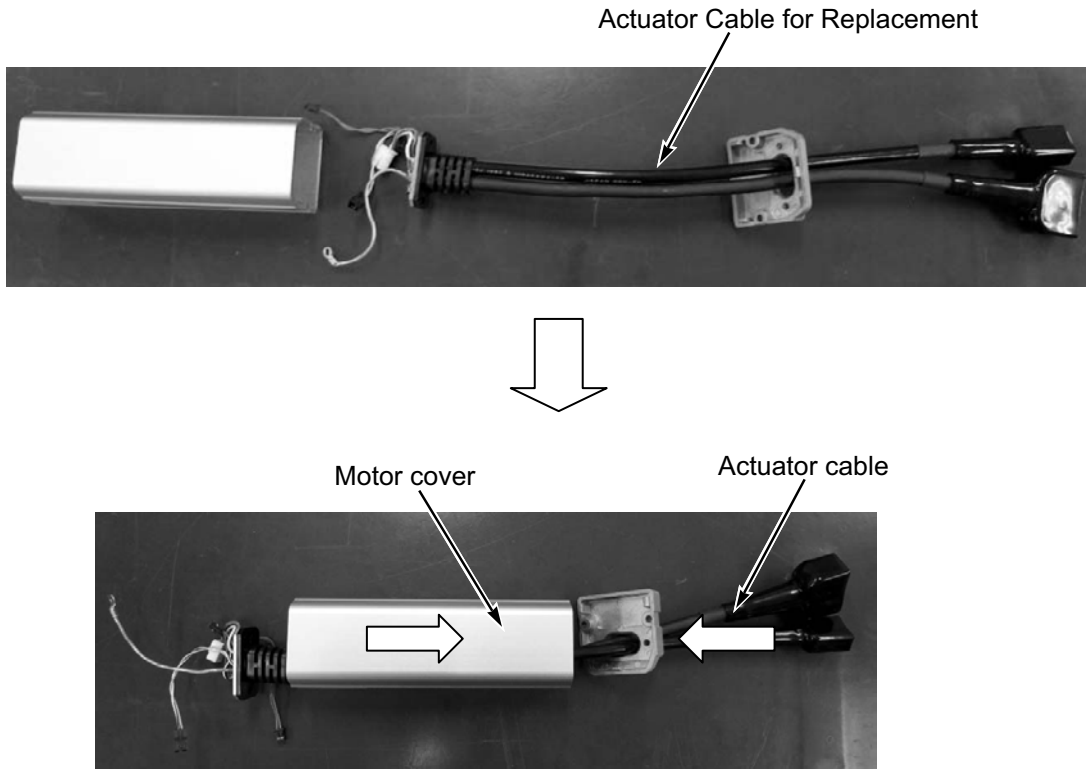

17) Attach the encoder relay cable that was taken off previously to the actuator cable for replacement.

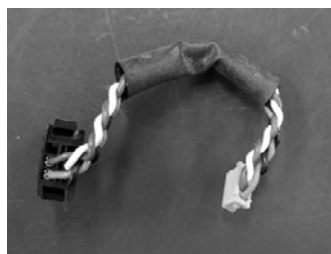

Encoder relay cable

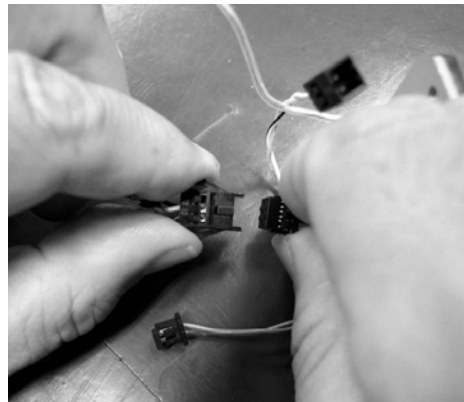

18) Install the attached cables.

- While holding the motor with one hand, insert the encoder cable.
(The photograph bellow shows the motor (Encoder by Tamagawa).)



- Install a grounding wire using a Phillips driver.



- Plug the cables into the motor.

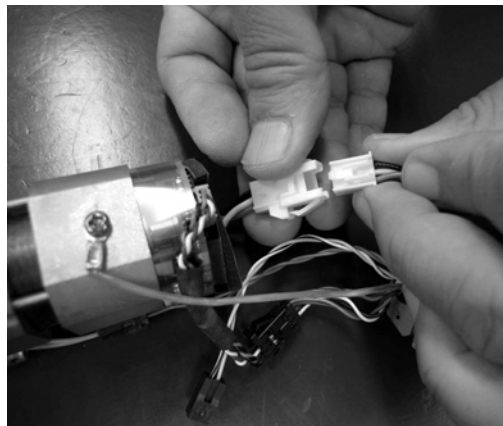

- 19) Insert the motor-end cover and cap.
Store the connector inside the motor-end cap.

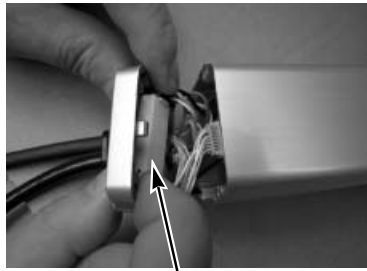

Store the connector inside the motor-end cap.

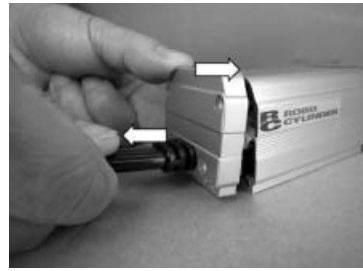

Pull out the cable end while pushing in the motor-end cap.

- 20) Use a Phillips screwdriver to securely tighten the affixing bolts for motor-end cap and attached cables.

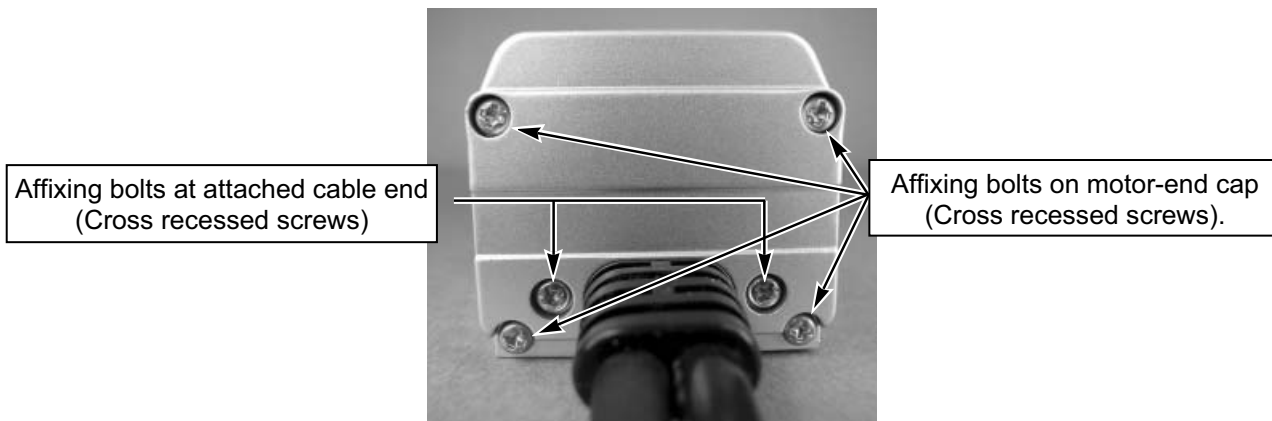

Affixing bolts at attached cable end
(Cross recessed screws)

Affixing bolts on motor-end cap
(Cross recessed screws).

- 21) Connect a PC or teaching pendant to the controller to perform homing. (If the actuator is of absolute encoder specification, an absolute reset must be performed.)
Check for deviation from the initial home position.
If there is a deviation when the SCON controller is being used, use home return offset distance of parameter No. 22 to make corrections. If the SSEL or the X-SEL controller is being used, use home preset value of axis-specific parameter No. 12 to make corrections.
For the absolute encoder specification, perform homing → absolute reset after changing the parameter.

11.10.3 Replacing the Motor of the Motor Straight Type (Coupling Type) : RCS2-SA7C

[Items Required for Replacement]

- Replacement motor • Allen wrench
- Scale
- Grease

Other than cleanroom specification

Idemitsu Kosan	Daphne Eponex Grease No. 2
----------------	----------------------------

Cleanroom specifications

KURODA Precision Industries	C Grease
-----------------------------	----------

- PC or teaching pendant

Replacement motor

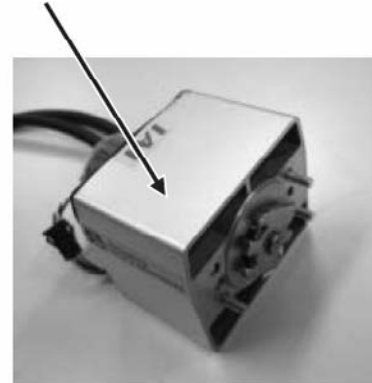

⚠ Caution: When replacing the motor, handle the replacement motor with due care. The actuator has been shipped with the encoder adjusted to an optimal position, so do not crush the encoder unit. It may displace the encoder, thus impairing proper actuator operation.

[Procedure]

- 1) Remove the motor-end cap affixing bolts using an Allen wrench.

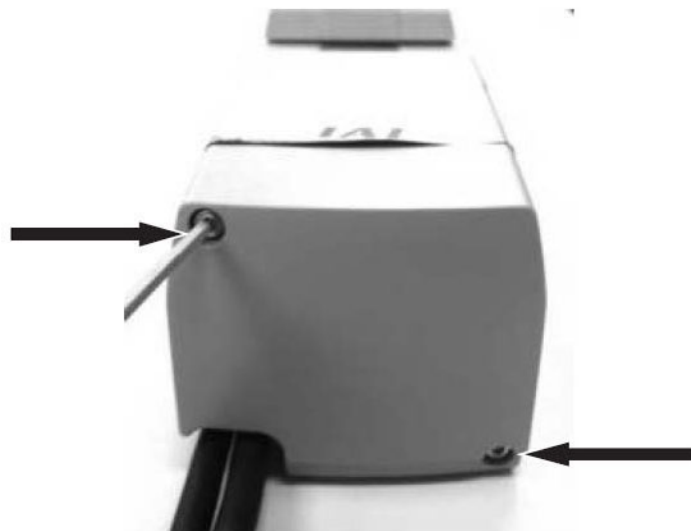

2) Pull out the motor-end cap.

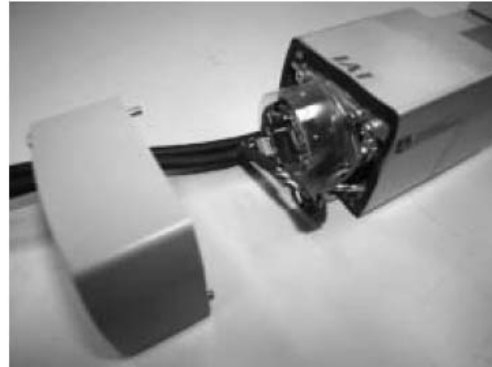
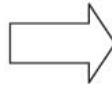

Push in the cable end while pulling out the motor-end cap.

3) Remove the grounding wire using an Allen wrench.

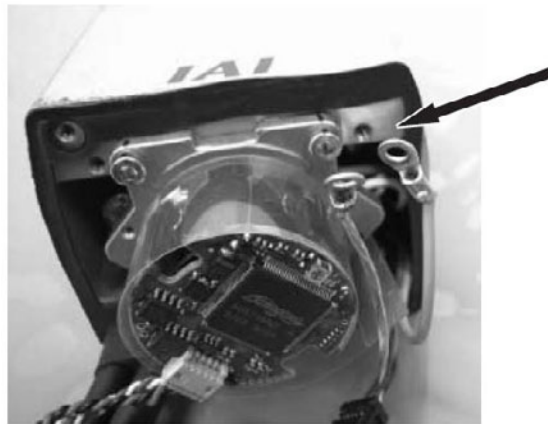

- 4) Remove the motor.
Remove the 4 motor affixing bolts that can be seen in the back using an Allen wrench.

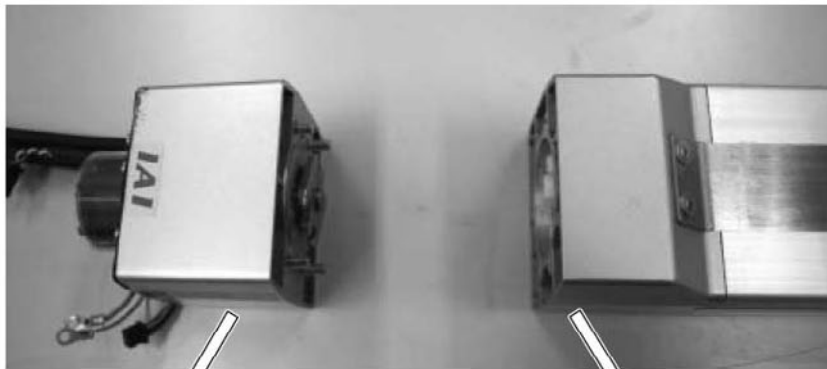
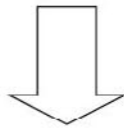
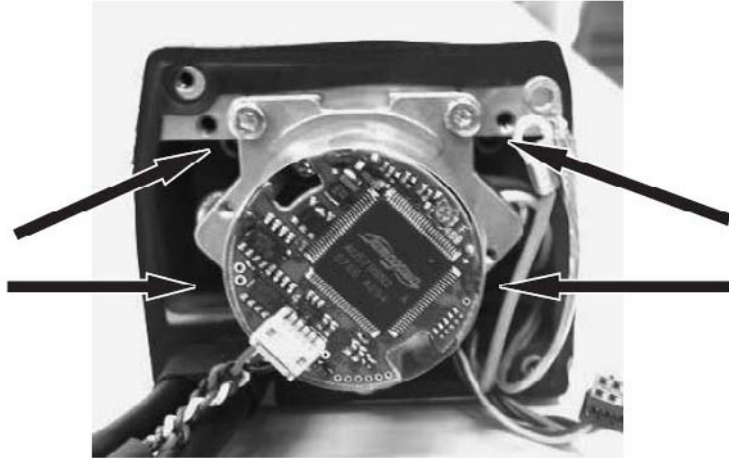

- 5) Apply grease on the coupling side of the actuator.

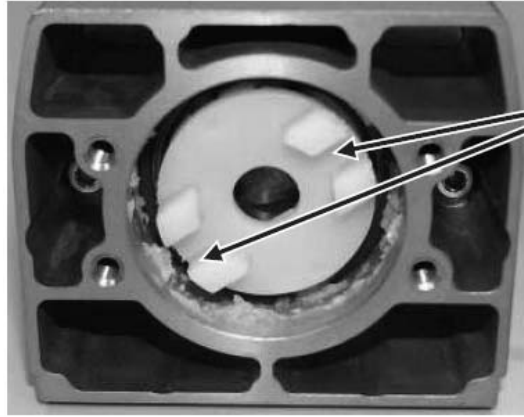

Apply grease on the inside of the coupling.

- 6) Insert the replacement motor coupling by aligning it with the current orientation of the actuator coupling.

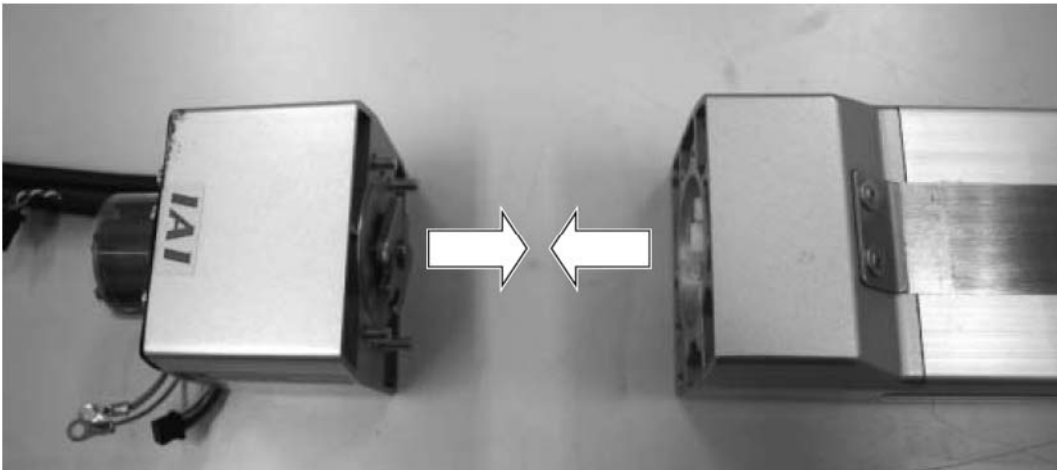

7) Tighten the 4 motor affixing bolts using an Allen wrench.

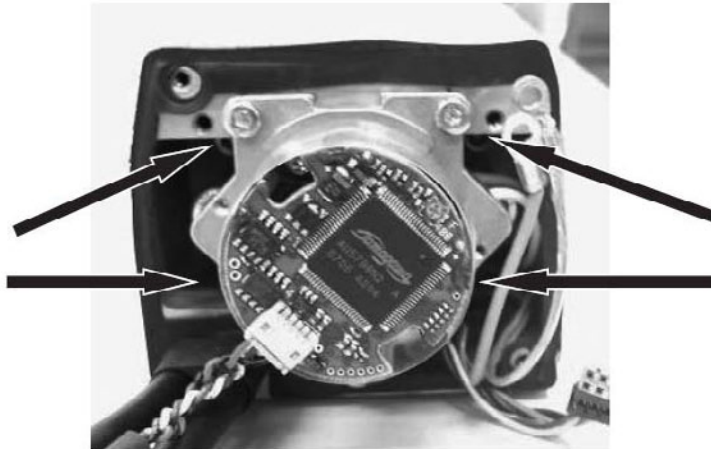

8) Install the grounding wires with screws using an Allen wrench.

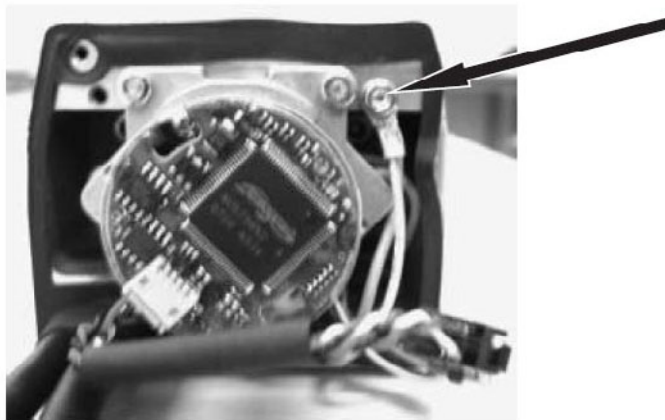

9) Insert the motor-end cap.



10) Tighten the motor-end cap affixing bolts using an Allen wrench.

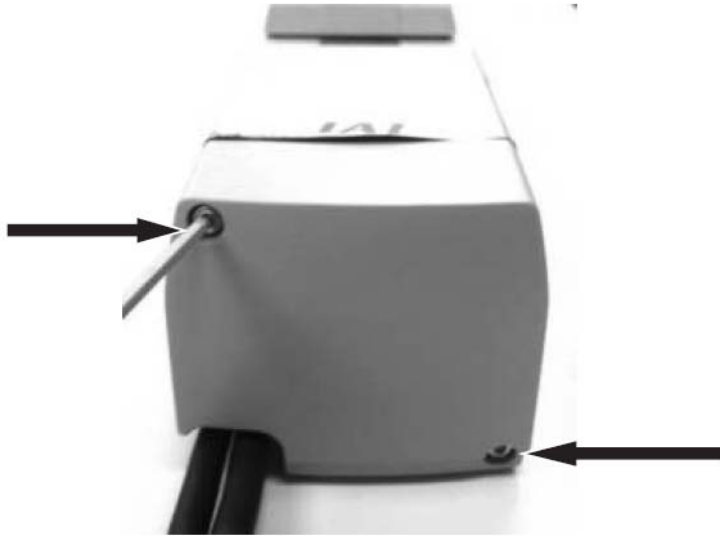

11) Connect a PC or teaching pendant to the controller to perform homing. (If the actuator is of absolute encoder specification, an absolute reset must be performed.)
After performing homing, make corrections using home return offset distance of parameter No. 22 if using the SCON controller so that the width between the mechanical end and the home position will be 3 mm.
If using the SSEL or the X-SEL controller, make corrections using home preset value of axis-specific parameter No. 12.
For the absolute encoder specification, perform Homing and Absolute Reset after changing the parameter.

11.10.4 Replacing the Motor of the Motor Straight Type (Coupling Type) : RCS2-SS7C, SS8C

- SS7C Type

[Items Required for Replacement]

- Replacement motor unit (with a coupling preinstalled on the motor shaft; see the photograph on the right)
- Note: Never remove the coupling.
- Allen wrenches • Scale • Oil-based marker pen



[Procedure]

- 1) Move the slider to a position where Z-phase turns on (reference home position).
On both standard actuators and actuators whose home is set on the opposite side, this position corresponds to 3 mm from the mechanical end.

[Standard specification]

Return the slider 3 mm from the mechanical end.

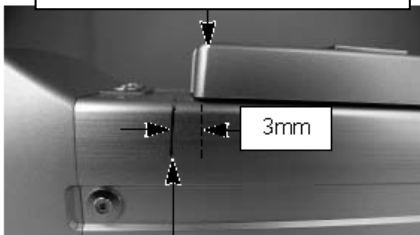

Draw a countermark with the slider contacting the mechanical

[Specification with home set on opposite side]

Return the slider 3 mm from the mechanical end.

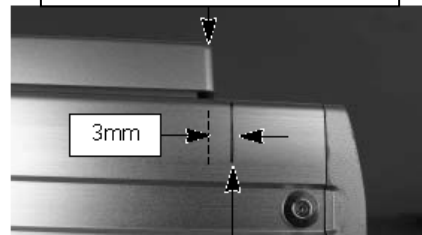

Draw a countermark with the slider contacting the mechanical end on the counter-motor side.

Warning: If the actuator is installed vertically, move it after turning on the controller power and forcibly releasing the brake. At this time, beware of danger as the actuator may drop suddenly.
Always provide a support to brace the actuator hand to prevent sudden drop, so as not to pinch fingers or damage the work part.

- 2) Using an Allen wrench of 2.5 mm across flats, remove the bolts affixing the motor-end cap and attached cables.

Affixing bolts at attached cable end

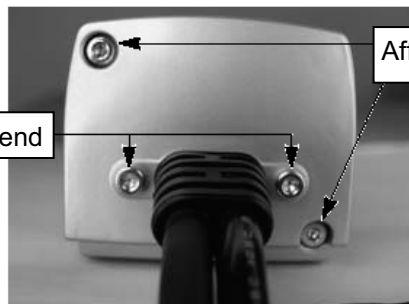

Affixing bolts on motor-end cap

3) Pull out the motor-end cap.

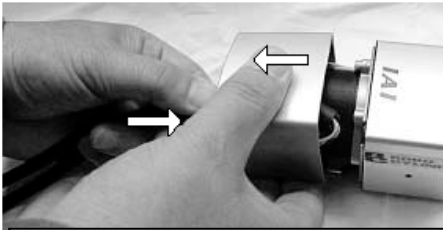

Push in the cable end while pulling out the motor-end cap.



4) Remove the motor.

Remove the two motor affixing bolts using an Allen wrench of 3 mm across flats.

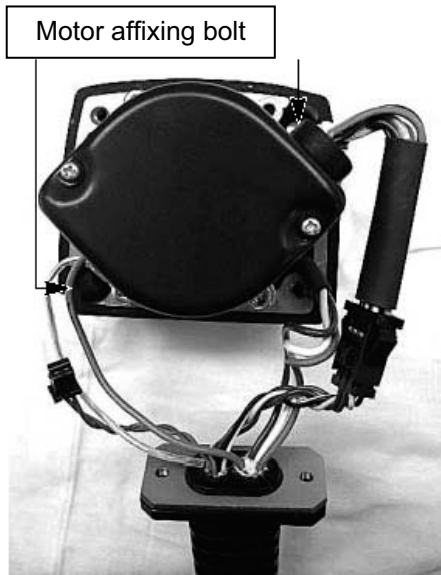

5) Using an Allen wrench of 2.5 mm across flats, remove the bolts affixing the end cap and attached cables on the replacement motor unit.

Affixing bolts at attached cable end

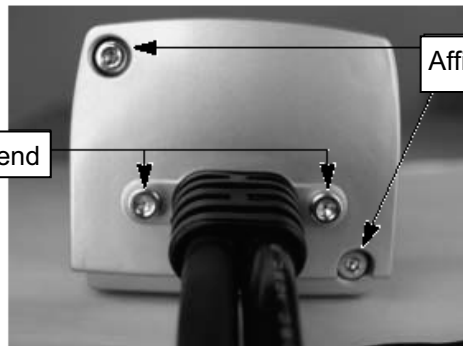

Affixing bolts on motor-end cap

6) Pull out the motor-end cap.

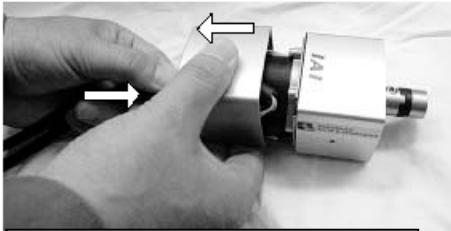

Push in the cable end while pulling out the motor-end cap.



7) Align the coupling position on the actuator side.
Fine-adjust the coupling position until the projection on the coupling lies vertical, with the slit facing left.

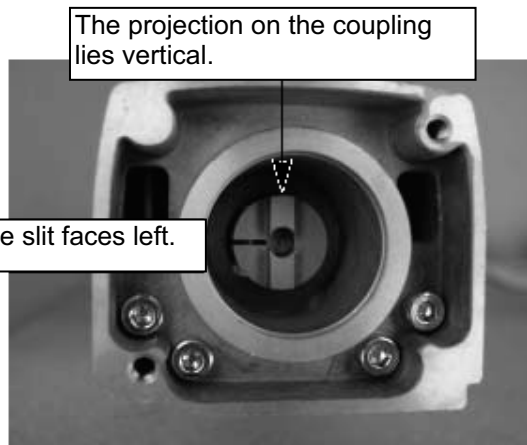

8) Position the new motor so that the slit in the coupling points to the 12 o'clock position, and install the motor in this condition by engaging its coupling with the coupling on the actuator side.



The slit in the coupling should point to the 12 o'clock position.



Using an Allen wrench of 3 mm across flats, uniformly tighten the two hexagon socket-head bolts (M4x25) affixing the motor to secure the motor.
Tightening torque: 176 N·cm (18.0 kgf·cm)

9) Install the motor-end cap.

- Carefully push in the motor-end cap by making sure the cables are not pinched.

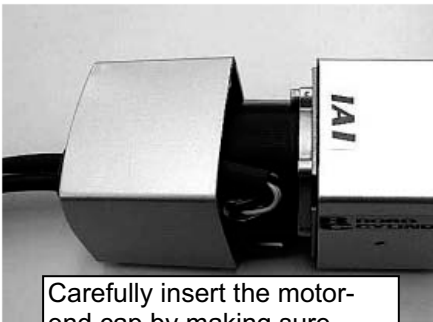

Carefully insert the motor-end cap by making sure cables are not pinched

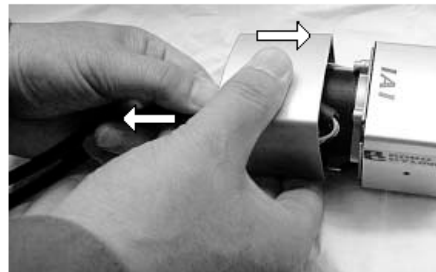

Pull out the cable end while pushing in the motor-end cap.

- Tighten the bolts while securely holding the cable end by hand.

Uniformly tighten the two hexagon socket-head bolts (M3x8) using an Allen wrench of 2.5 mm across flats.

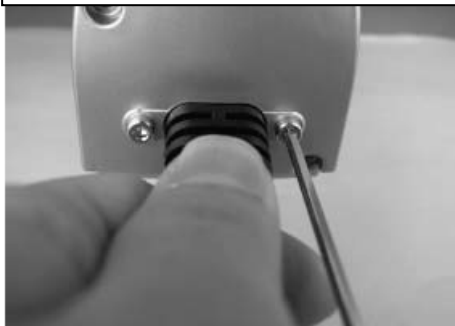

- Affix the motor-end cap.

Uniformly tighten the two hexagon socket-head bolts (M3x50) using an Allen wrench of 2.5 mm across flats.
Tightening torque: 83 N·cm (8.47 kgf·cm)

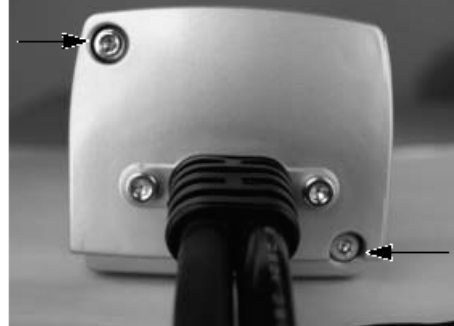

10) Correct the position deviation.

[Incremental encoder]

- [1] Check the home position.
Turn on the controller power.
Use the PC software or teaching pendant to perform homing to check the home position. Repeat homing several times to confirm that the actuator returns to the same position every time.
- [2] Check the amount of position deviation.
The home position may have shifted slightly after the motor replacement.
To check the amount of position deviation, select a desired position number appropriate for checking the deviation after the motor replacement, perform positioning to the selected position, and measure the amount of deviation.
- [3] Correct the deviation.
If there is a deviation from the initial home position when the SCON controller is being used, make corrections using home return offset distance of parameter No. 22. If the SSEL or the X-SEL controller is being used, make corrections using home preset value of the axis-specific parameter No. 12.

[Absolute encoder]

- [1] Check the home position.
Turn on the controller power.
When the controller is turned on for the first time after the motor has been replaced, a battery voltage low alarm should generate. Reset this alarm.
Next, use the PC software or teaching pendant to perform homing, and then perform an absolute reset.
Thereafter, repeat homing several times to confirm that the actuator returns to the same position every time.
- [2] Check the amount of position deviation.
The home position may have shifted slightly after the motor replacement.
To check the amount of position deviation, select a desired position number appropriate for checking the deviation after the motor replacement, perform positioning to the selected position, and measure the amount of deviation.
- [3] Correct the deviation.
If there is a deviation from the initial home position when the SCON controller is being used, make corrections using home return offset distance of parameter No. 22. If the SSEL or the X-SEL controller is being used, make corrections using the home preset value of axis-specific parameter No. 12.
In addition, after changing the parameter, perform homing → absolute reset.

[Home Return Offset Distance (SCON) and Home Preset Value (SSEL and X-SEL) Correction Example]

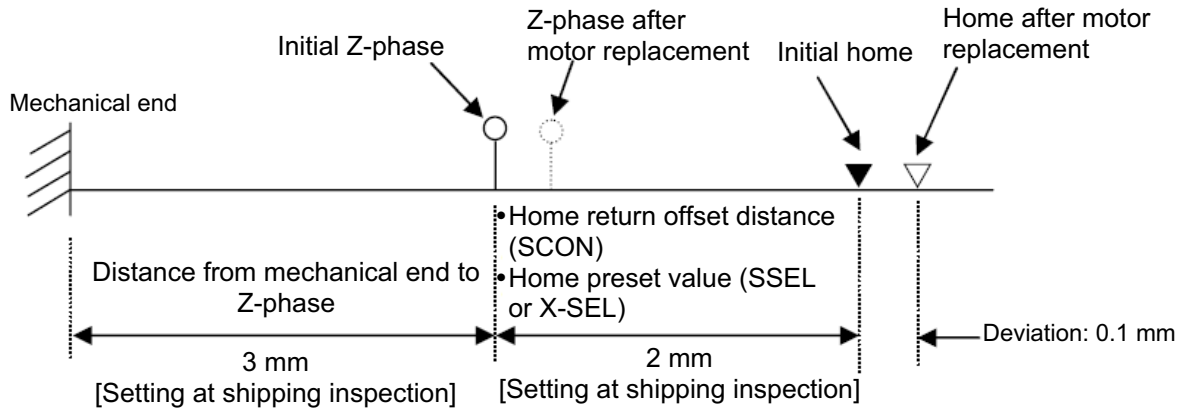

If, after the motor replacement, the home position became deviated by 0.1 mm in the direction of moving away from the mechanical end.

In this case, to align it with the initial home position when the SCON controller is being used, reduce the home return offset distance of parameter No. 22 by 0.1 mm. If the SSEL or the X-SEL controller is being used, reduce the home preset value of axis-specific parameter No. 12 by 0.1 mm.

(Change from 2 mm to 1.9 mm.)

- SS8C Type (For Rigid Coupling Type)

There is a cap attached as shown in the picture below for Rigid Coupling Type.

If there is no cap, it is Oldham's Coupling Type.

Follow the procedures of replacement for Oldham's Coupling Type stated after this instruction.

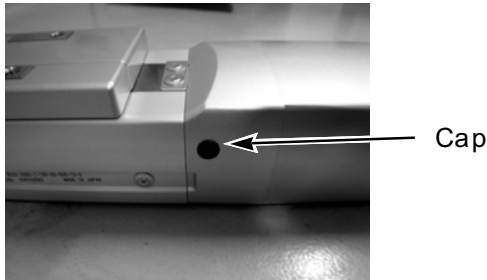

[Items Required for Replacement]

- Replacement motor (with a coupling preinstalled on the motor shaft; see the photograph on the right)
- Note: Never remove the coupling.
- Allen wrenches ● Scale ● Oil-based marker pen



1) Using an Allen wrench of 2.5 mm across flats, remove the bolts affixing the motor-end cap and attached cables.

- Affixing bolts at attached cable end

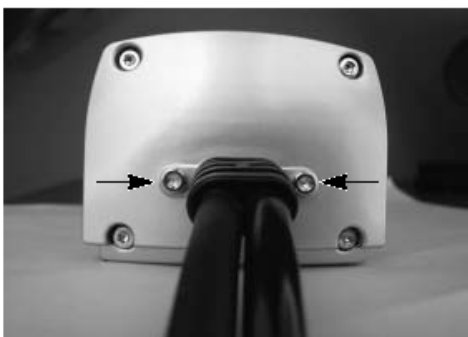

- Affixing bolts on motor-end cap

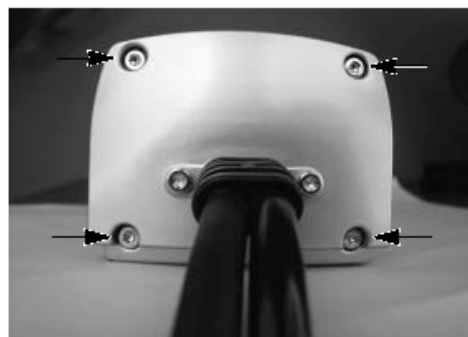

2) Pull out the motor-end cap.

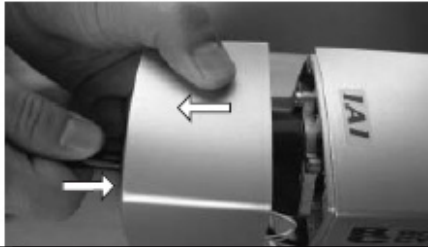

Push in the cable end while pulling out the motor-end cap.



3) Remove the attached cables.

- Pull out the motor connector.



- Pull out the encoder connector.

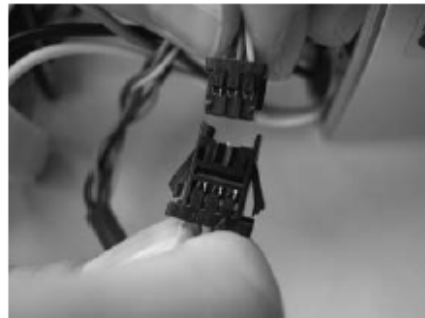

* If the actuator is equipped with a brake, pull out the brake connector.

- Remove the bolts affixing the grounding and shield wires using an Allen wrench of 2.5 mm across flats.

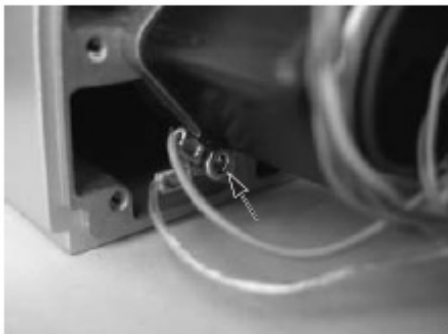

- Remove the attached cables.



- 4) Take out the seal on the motor cover on the bottom so the bolt on the rigid coupling can be loosened.

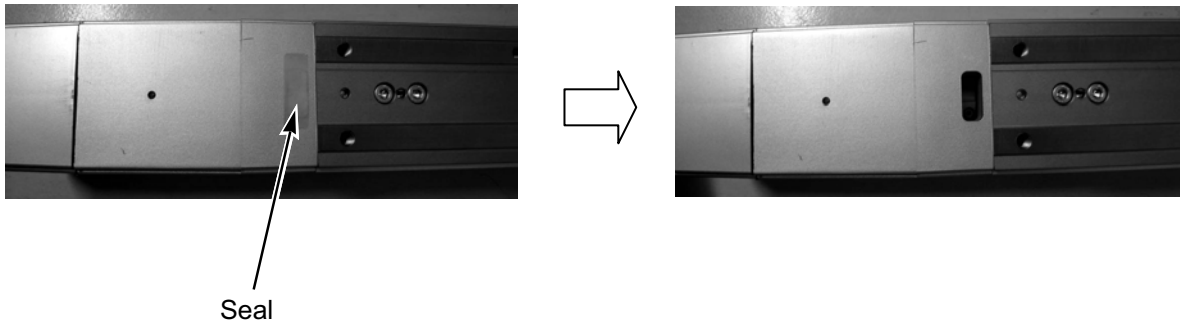

- 5) Move the slider to a point where the bolt can be seen in the hole.
Twist the bolt with using a 2.5mm Allen wrench to loosen it.



- 6) Remove the motor.
Remove the four motor affixing bolts using an Allen wrench of 3 mm across flats.

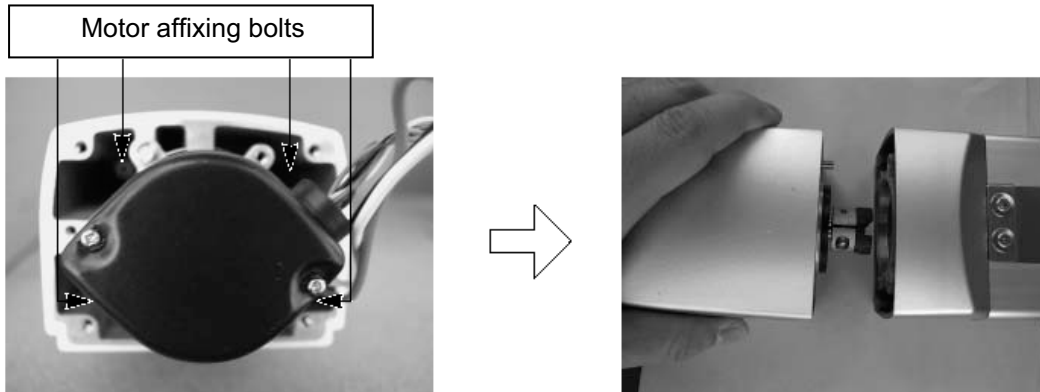

[Structure of 150-watt type]

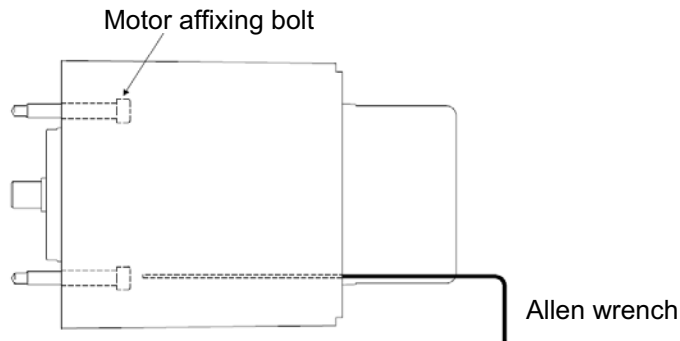

- 7) Move the slider to a position where Z-phase turns ON (reference home position).
On both standard actuators and actuators whose home is set on the opposite side, this position corresponds to 2.5 mm from the mechanical end.

[Standard specification]

Return the slider 2.5 mm from the mechanical end.

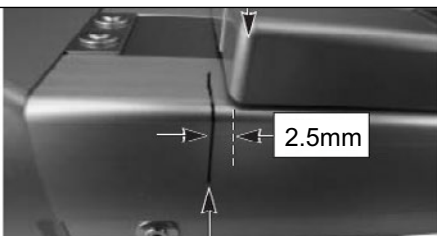

Draw a countermark with the slider contacting the mechanical end.

[Specification with home set on opposite side]

Return the slider 2.5 mm from the mechanical end.

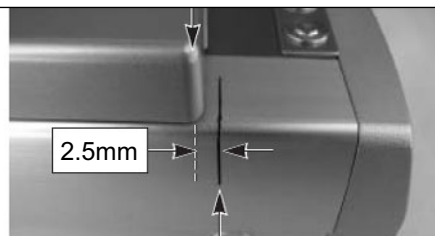

Draw a countermark with the slider contacting the mechanical end on the counter-motor side

Warning: If the actuator is installed vertically, move it after turning on the controller power and forcibly releasing the brake. At this time, beware of danger as the actuator may drop suddenly. Always provide a support to brace the actuator hand to prevent sudden drop, so as not to pinch fingers or damage the work part.

- 8) Position the new motor so that the slit in the coupling points to the 12 o'clock position, and install the motor in this condition by engaging its coupling with the coupling on the actuator side.

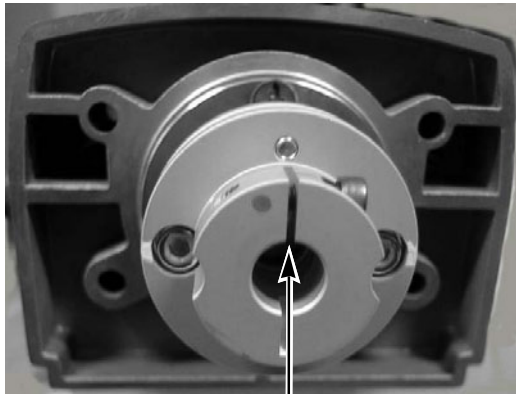

The slit in the coupling should point to the 12 o'clock position.

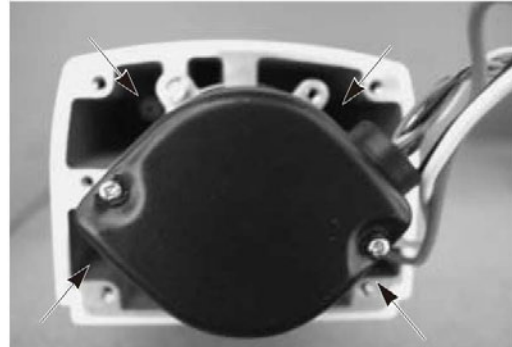

Using an Allen wrench of 3 mm across flats, uniformly tighten the four hexagon socket-head bolts (M4×25) affixing the motor to secure the motor.
Tightening torque: 176 N·cm (18.0 kgf·cm)

- 9) Twist the bolt with using a 2.5mm Allen wrench to tighten it. Stick on the seal after tightening the bolt.

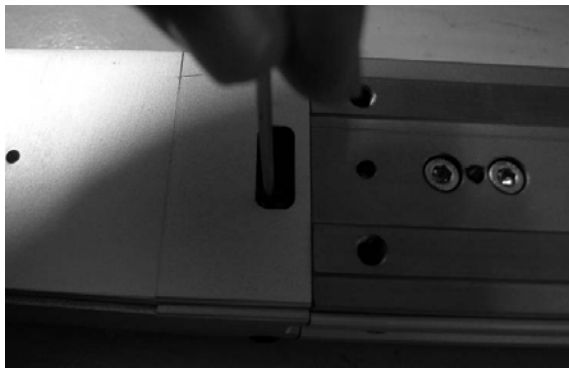

Tightening Torque 200 to 240 N·cm (20.4 to 24.5 kgf·cm)

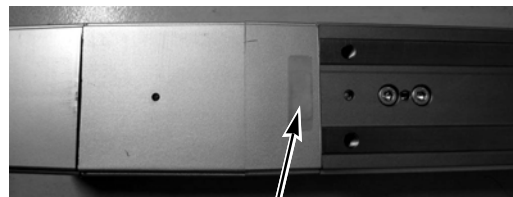
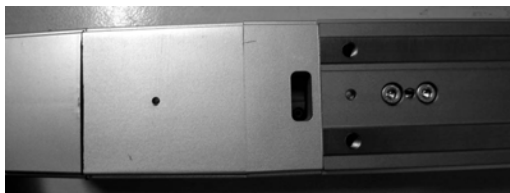

Seal

10) Affix the grounding and shield wires for the attached cables.

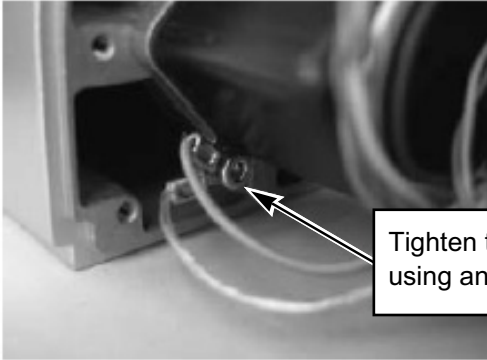

Tighten the hexagon socket head bolt (M3×8) using an Allen wrench of 2.5 mm across flats.

11) Connect the relay connectors (for the motor, encoder and brake).

- Store the motor connector into the space at the rear of the encoder protection cap above the cap.

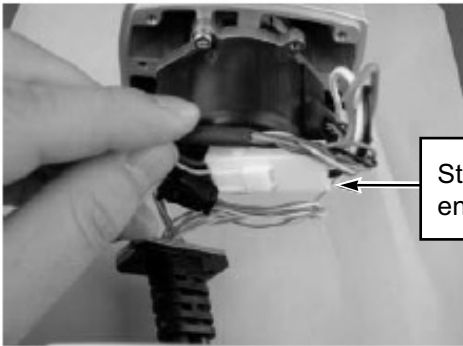

Store the into the space at the rear of the encoder protection cap above the cap.

12) Install the motor-end cap.

- Carefully push in the motor-end cap by making sure the cables are not pinched.

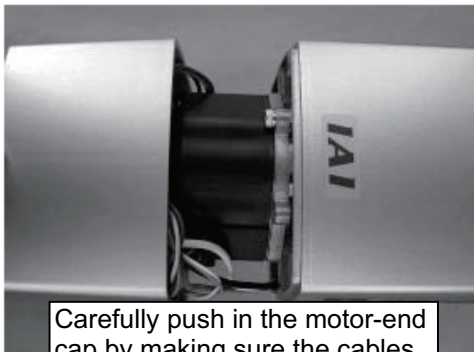

Carefully push in the motor-end cap by making sure the cables are not pinched.

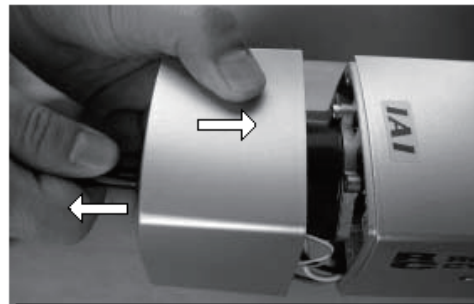

Pull out the cable end while pushing in the motor-end cap.

- Tighten the bolts while securely holding the cable end by hand.

Uniformly tighten the two hexagon socket-head bolts (M3×8) using an Allen wrench of 2.5 mm across flats.

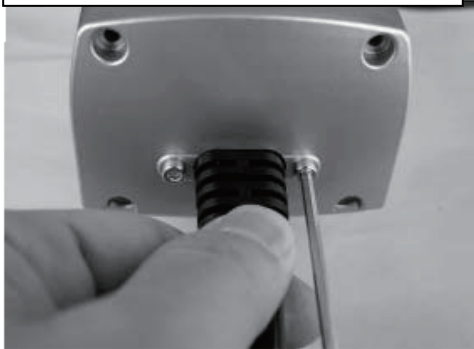

- Affix the motor-end cap.

Uniformly tighten the two hexagon socket-head bolts (M3×50) using an Allen wrench of 2.5 mm across flats.
Tightening torque: 83 N·cm (8.47 kgf·cm)

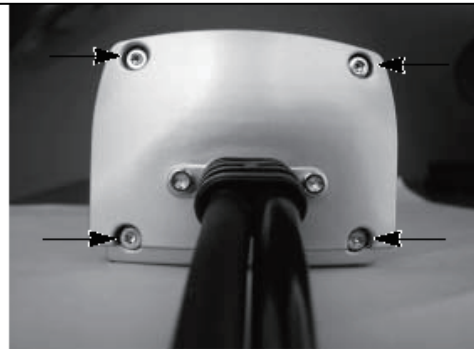

13) Correct the position deviation.

[Incremental encoder]

[1] Check the home position.

Turn on the controller power.

Use the PC software or teaching pendant to perform homing to check the home position. Repeat homing several times to confirm that the actuator returns to the same position every time.

[2] Check the amount of position deviation.

The home position may have shifted slightly after the motor replacement.

To check the amount of position deviation, select a desired position number appropriate for checking the deviation after the motor replacement, perform positioning to the selected position, and measure the amount of deviation.

[3] Correct the deviation.

If there is a deviation from the initial home position when the SCON controller is being used, make corrections using home return offset distance of parameter No. 22. If the SSEL or the X-SEL controller is being used, make corrections using home preset value of the axis-specific parameter No. 12.

[Absolute encoder]

- [1] Check the home position.
Turn on the controller power.
When the controller is turned on for the first time after the motor has been replaced, a battery voltage low alarm should generate. Reset this alarm.
Next, use the PC software or teaching pendant to perform homing, and then perform an absolute reset.
Thereafter, repeat homing several times to confirm that the actuator returns to the same position every time.
- [2] Check the amount of position deviation.
The home position may have shifted slightly after the motor replacement.
To check the amount of position deviation, select a desired position number appropriate for checking the deviation after the motor replacement, perform positioning to the selected position, and measure the amount of deviation.
- [3] Correct the deviation.
If there is a deviation when the SCON controller is being used, use home return offset distance of parameter No. 22 to make corrections. If the SSEL or the X-SEL controller is being used, use home preset value of axis-specific parameter No. 12 to make corrections.
In addition, after changing the parameter, perform homing → absolute reset.

[Home Return Offset Distance (SCON) and Home Preset Value (SSEL and X-SEL) Correction Example]

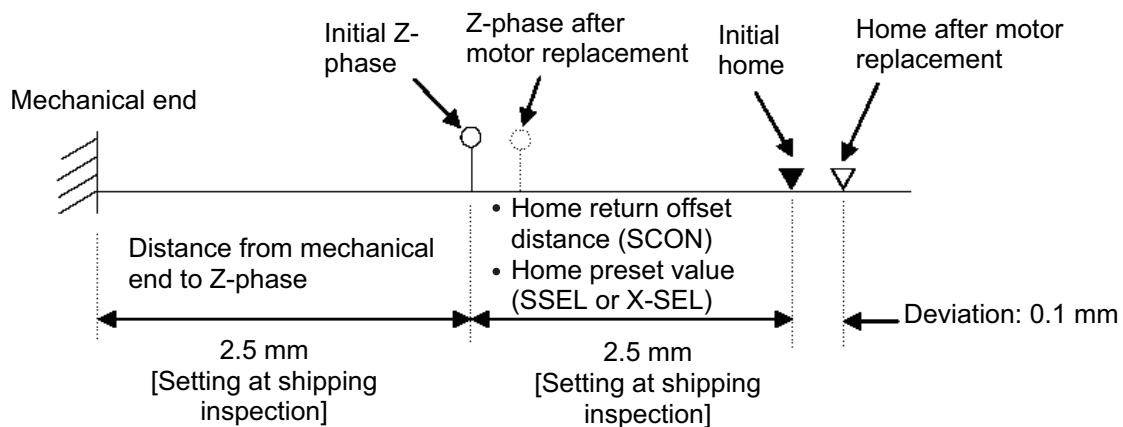

If, after the motor replacement, the home position became deviated by 0.1 mm in the direction of moving away from the mechanical end.

In this case, to align it with the initial home position when the SCON controller is being used, reduce the home return offset distance of parameter No. 22 by 0.1 mm. If the SSEL or the X-SEL controller is being used, reduce the home preset value of axis-specific parameter No. 12 by 0.1 mm.

(Change from 2.5 mm to 2.4 mm.)

- SS8C Type (For Oldham's Coupling Type)

[Items Required for Replacement]

- Replacement motor (with a coupling preinstalled on the motor shaft; see the photograph on the right)
Note: Never remove the coupling.
- Allen wrenches ● Scale ● Oil-based marker pen



[Procedure]

- 1) Move the slider to a position where Z-phase turns on (reference home position).
On both standard actuators and actuators whose home is set on the opposite side, this position corresponds to 2.5 mm from the mechanical end.

[Standard specification]

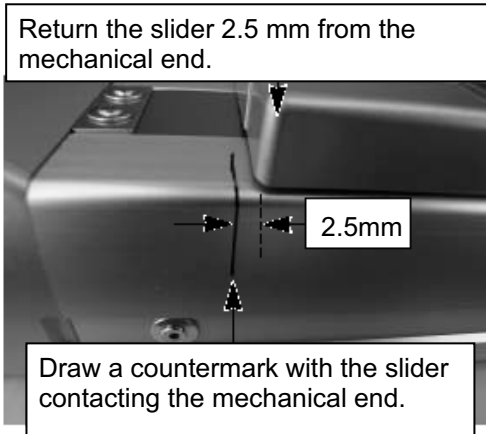

[Specification with home set on opposite side]

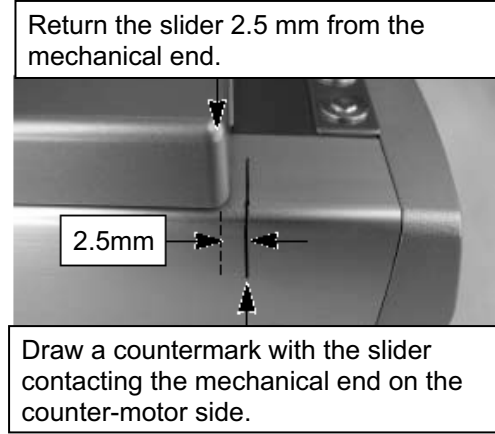

Warning: If the actuator is installed vertically, move it after turning on the controller power and forcibly releasing the brake. At this time, beware of danger as the actuator may drop suddenly. Always provide a support to brace the actuator hand to prevent sudden drop, so as not to pinch fingers or damage the work part.

- 2) Using an Allen wrench of 2.5 mm across flats, remove the bolts affixing the motor-end cap and attached cables.

- Affixing bolts at attached cable end

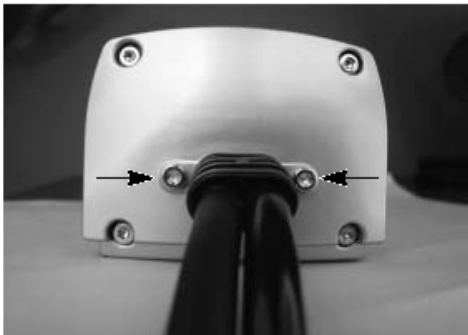

- Affixing bolts on motor-end cap

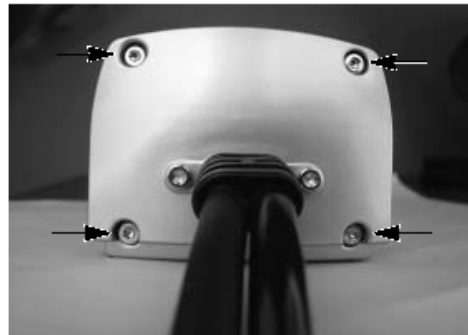

3) Pull out the motor-end cap.

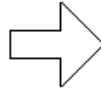
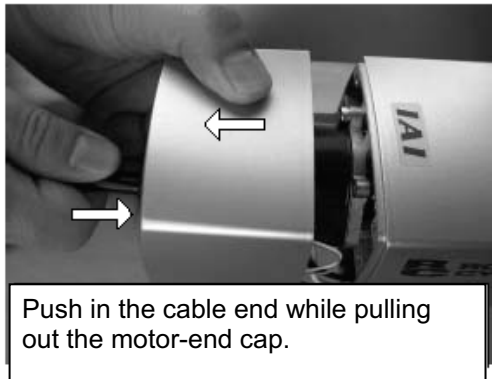

4) Remove the attached cables.

- Pull out the motor connector.



- Pull out the encoder connector.

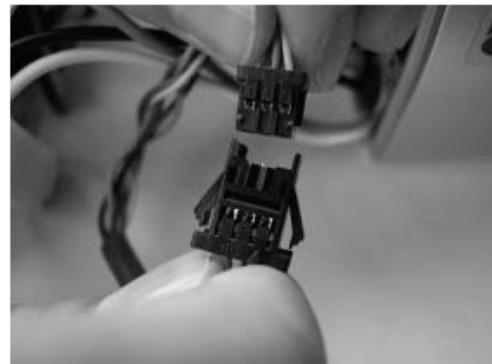

* If the actuator is equipped with a brake, pull out the brake connector.

- Remove the bolts affixing the grounding and shield wires using an Allen wrench of 2.5 mm across flats.

- Remove the attached cables.

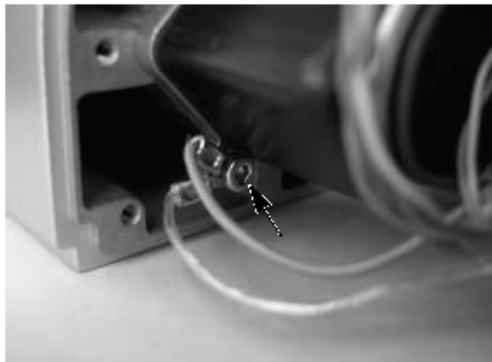

- 5) Remove the motor.
Remove the four motor affixing bolts using an Allen wrench of 3 mm across flats.

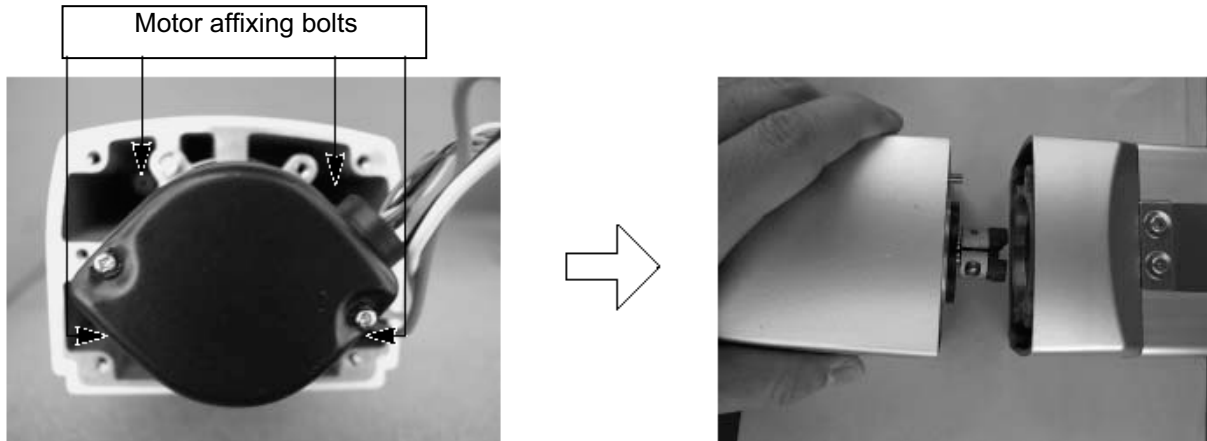

[Structure of 150-watt type]

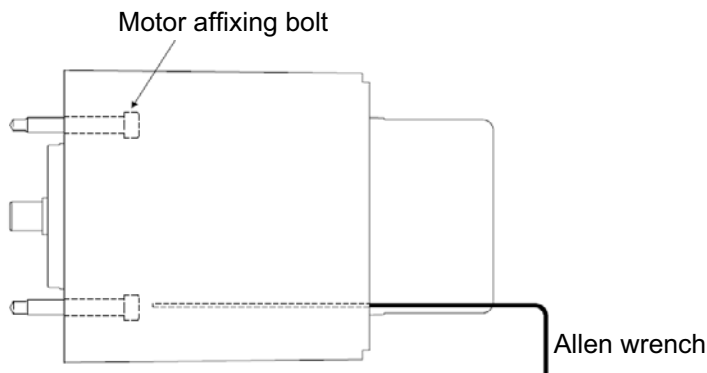

- 6) Align the coupling position on the actuator side.
Fine-adjust the coupling position until the projection on the coupling lies vertical, with the slit facing left.

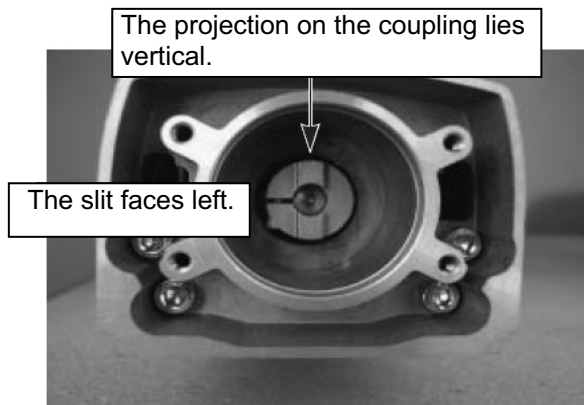

- 7) Position the new motor so that the slit in the coupling points to the 12 o'clock position, and install the motor in this condition by engaging its coupling with the coupling on the actuator side.

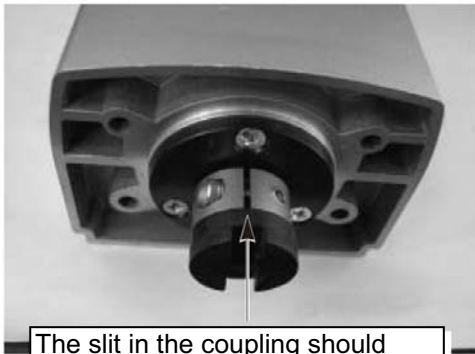

The slit in the coupling should point to the 12 o'clock position.



Using an Allen wrench of 3 mm across flats, uniformly tighten the four hexagon socket-head bolts (M4x25) affixing the motor to secure the motor.
Tightening torque: 176 N-cm (18.0 kgf-cm)

- 8) Affix the grounding and shield wires for the attached cables.

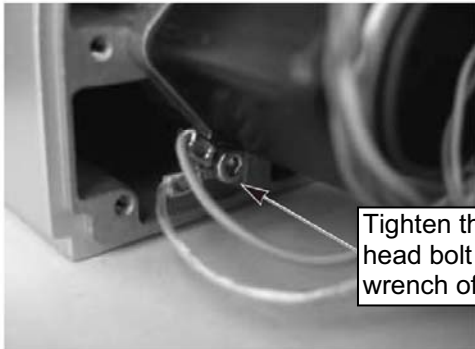

Tighten the hexagon socket-head bolt (M3x8) using an Allen wrench of 2.5 mm across flats.

- 9) Connect the relay connectors (for the motor, encoder and brake).
- Store the motor connector into the space at the rear of the encoder protection cap above the cap.



Store the motor connector into the space at the rear of the encoder protection cap above the cap.

- 10) Install the motor-end cap.
- Carefully push in the motor-end cap by making sure the cables are not pinched.

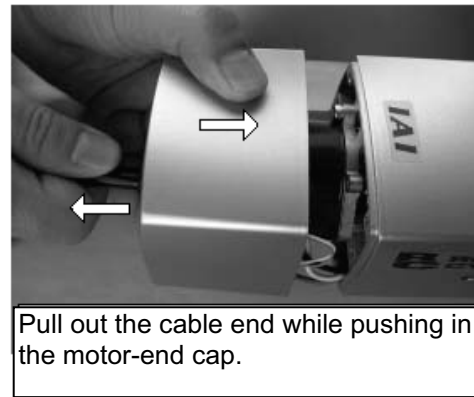
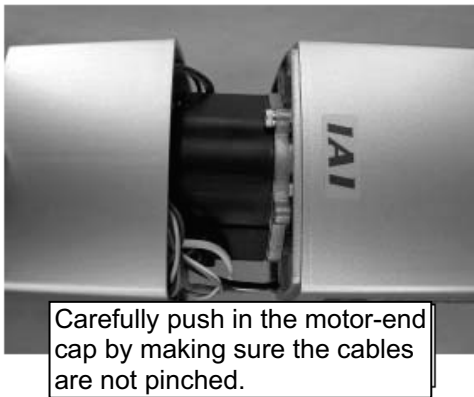

- Tighten the bolts while securely holding the cable end by hand.

Uniformly tighten the two hexagon socket-head bolts (M3x8) using an Allen wrench of 2.5 mm across flats.

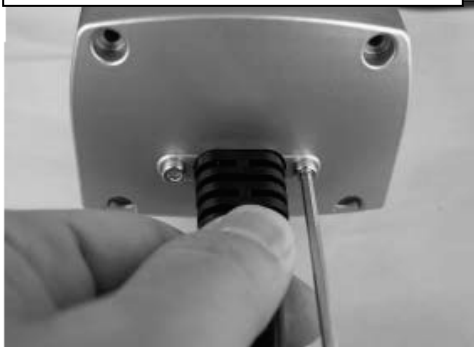

- Affix the motor-end cap.

Uniformly tighten the four hexagon socket-head bolts (M3x50) using an Allen wrench of 2.5 mm across flats.
Tightening torque: 83 N-cm (8.47 kgf-cm)

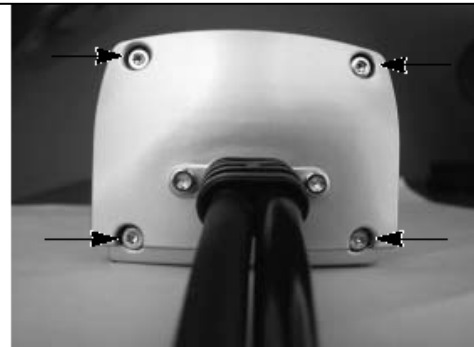

- 11) Correct the position deviation.

[Incremental encoder]

- [1] Check the home position.
Turn on the controller power.
Use the PC software or teaching pendant to perform homing to check the home position. Repeat homing several times to confirm that the actuator returns to the same position every time.
- [2] Check the amount of position deviation.
The home position may have shifted slightly after the motor replacement.
To check the amount of position deviation, select a desired position number appropriate for checking the deviation after the motor replacement, perform positioning to the selected position, and measure the amount of deviation.
- [3] Correct the deviation.
If there is a deviation from the initial home position when the SCON controller is being used, make corrections using home return offset distance of parameter No. 22. If the SSEL or the X-SEL controller is being used, make corrections using home preset value of the axis-specific parameter No. 12.

[Absolute encoder]

- [1] Check the home position.
Turn on the controller power.
When the controller is turned on for the first time after the motor has been replaced, a battery voltage low alarm should generate. Reset this alarm.
Next, use the PC software or teaching pendant to perform homing, and then perform an absolute reset.
Thereafter, repeat homing several times to confirm that the actuator returns to the same position every time.
- [2] Check the amount of position deviation.
The home position may have shifted slightly after the motor replacement.
To check the amount of position deviation, select a desired position number appropriate for checking the deviation after the motor replacement, perform positioning to the selected position, and measure the amount of deviation.
- [3] Correct the deviation.
If there is a deviation when the SCON controller is being used, use home return offset distance of parameter No. 22 to make corrections. If the SSEL or the X-SEL controller is being used, use home preset value of axis-specific parameter No. 12 to make corrections.
In addition, after changing the parameter, perform homing → absolute reset.

[Home Return Offset Distance (SCON) and Home Preset Value (SSEL and X-SEL) Correction Example]

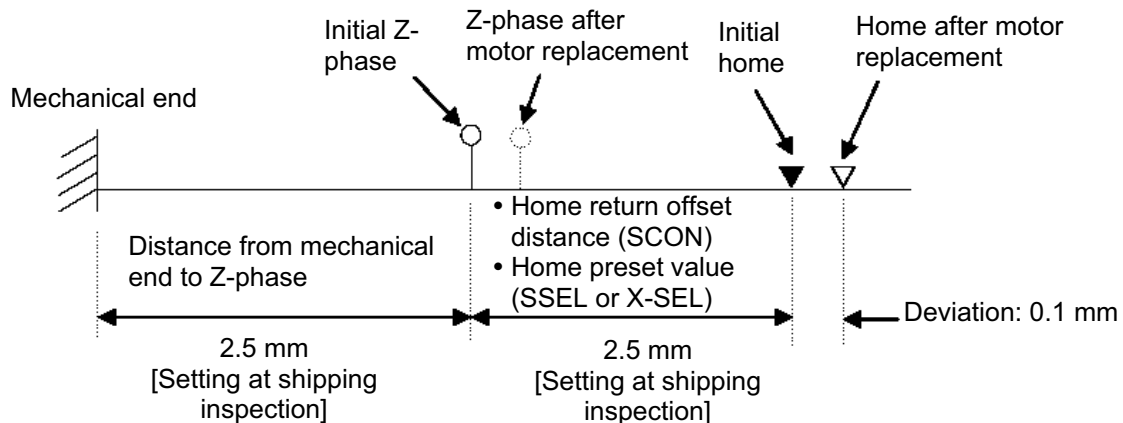

If, after the motor replacement, the home position became deviated by 0.1 mm in the direction of moving away from the mechanical end.
In this case, to align it with the initial home position when the SCON controller is being used, reduce the home return offset distance of parameter No. 22 by 0.1 mm. If the SSEL or the X-SEL controller is being used, reduce the home preset value of axis-specific parameter No. 12 by 0.1 mm.
(Change from 2.5 mm to 2.4 mm.)

11.10.5 Replacing the Motor of the Motor Reversing Type: RCS2-SA4R, SA5R, SA6R

[Items Required for Replacement]

- Replacement motor
- Allen wrenches
- Phillips screwdriver
- Tension gauge (capable of tensioning to 7 kgf or greater)
- Strong string, looped (or long tie-band)
- Scale
- Oil-based marker pen
- PC or teaching pendant

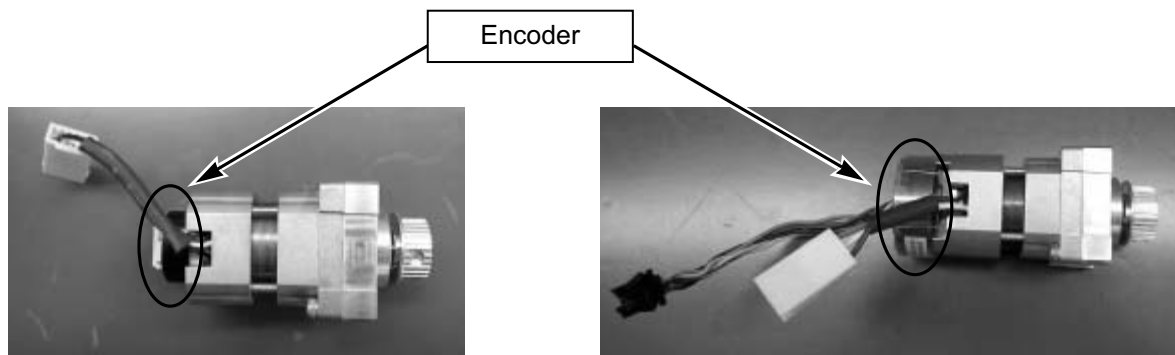

Replacement motor (Encoder by IAI)

Replacement motor (Encoder by Tamagawa)



Caution: When replacing the motor, handle the replacement motor with due care. The actuator has been shipped with the encode adjusted to an optimal position, so do not crush the encoder unit. It may displace the encoder, thus impairing proper actuator operation.

[Overview of Replacement]

- 1) Loosen the motor-unit affixing bolts to remove the belt, and replace the motor.
- 2) Restore the home position.
Affix the slider at a position 2 mm from the mechanical end on the home side, pass the belt, and adjust the belt to the specified tension.
- 3) Perform homing using a PC or teaching pendant and check for deviation from the initial home position. If there is a deviation when the SCON controller is being used, use home return offset distance to make the adjustments. If the SSEL or the X-SEL controller is being used, use home preset value to make the adjustments.

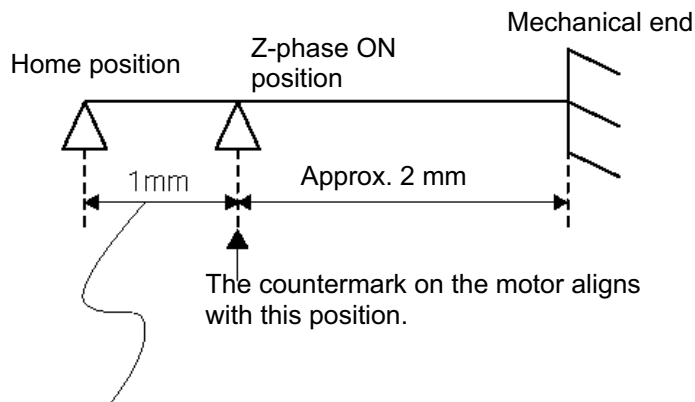

Use Parameter home return offset distance (SCON) or home preset value (SSEL and X-SEL) to specify the settings (The values displayed above are factory default settings).

[Procedure]

1) Remove the pulley cover using a Phillips screwdriver.



Cross recessed screws: M3

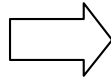

2) Use a Phillips screwdriver to remove the bolts affixing the motor-end cap and attached cables.

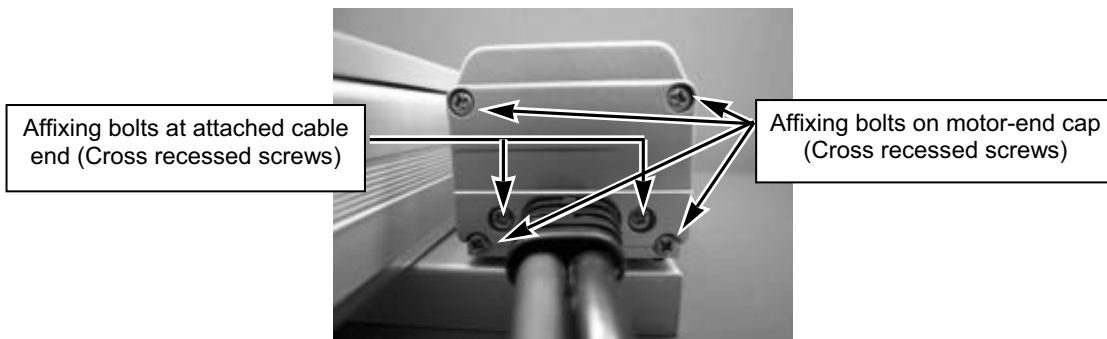

3) Pull out the motor-end cap.



Push in the cable end while pulling out the motor-end cap.



- 4) Pull out the motor-end cover to expose the motor.



- 5) Detach the attached cables.
 - Pull out the motor connector.



- If the actuator has a brake, also detach the brake connector.

- Remove the grounding wire using a Phillips screwdriver.

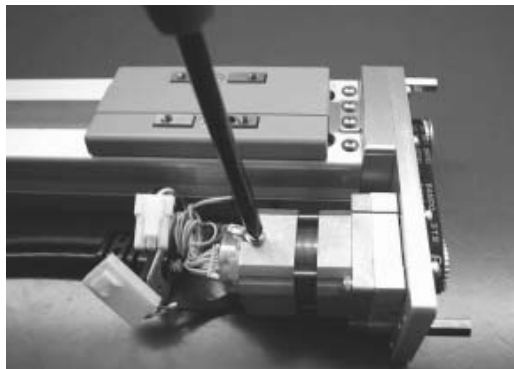

- While holding the motor with one hand, pull out the encoder cable. (The photograph bellow shows the motor (Encoder by IAI).)



- 6) Detach the attached cables.



- 7) Loosen the motor-unit affixing bolts using an Allen wrench of 2.5 mm across flats. Slide the motor, and loosen and remove the belt. After the belt has been removed, remove the motor-unit affixing bolts.

Motor-unit affixing bolts
(Use an Allen wrench of 2.5 mm across flats.)

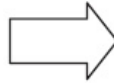
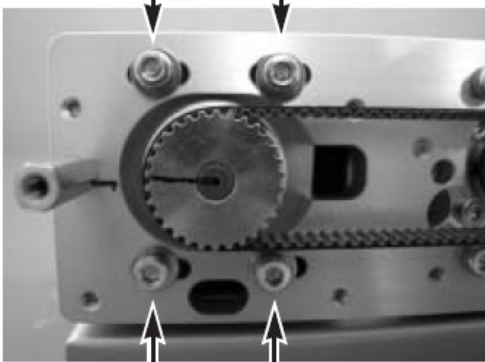

Motor-unit affixing bolts
(Use an Allen wrench of 2.5 mm across flats.)

- 8) Take out the motor.

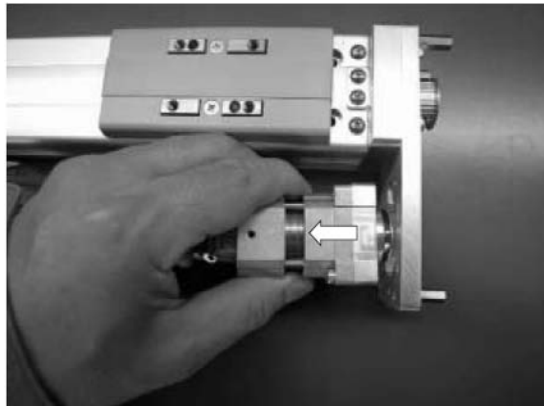

- 9) Install the replacement motor. Loosely tighten the motor-unit affixing bolts.

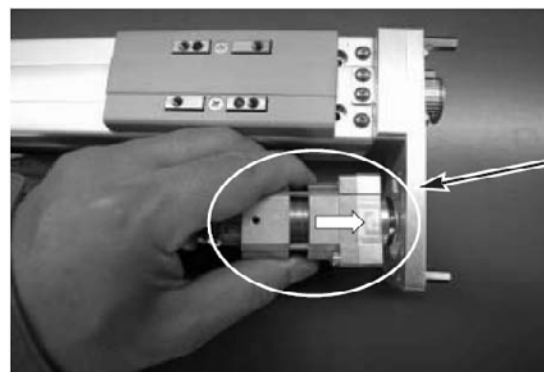

Replacement motor

- 10) Move the slider to a position where Z-phase turns on (home position).
On both standard actuators and actuators whose home is set on the opposite side, this position corresponds to 2 mm from the mechanical end.

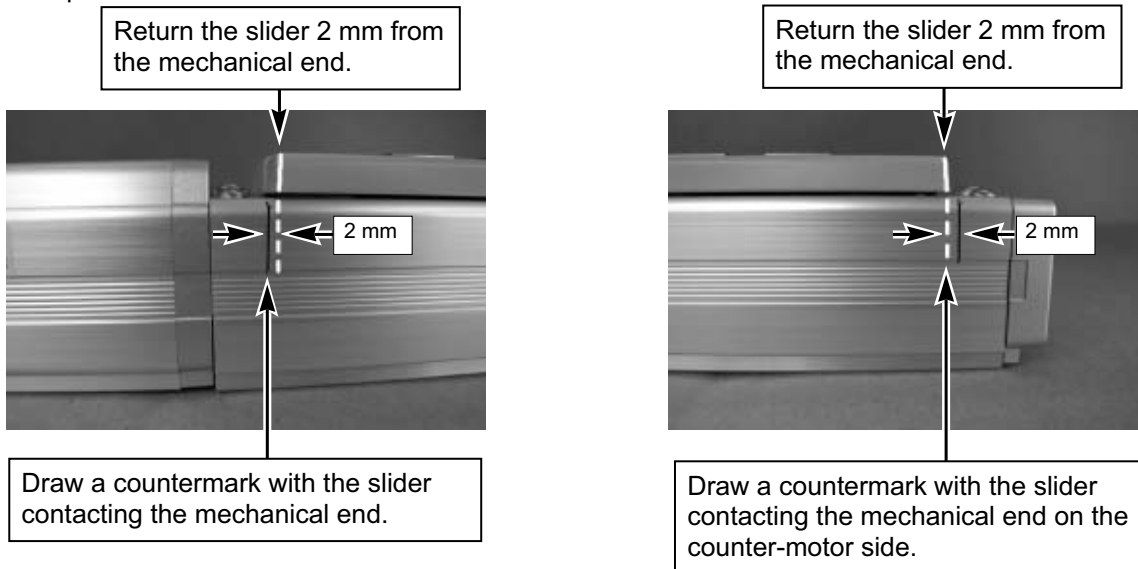

Warning: If the actuator is installed vertically, move it after turning on the controller power and forcibly releasing the brake. At this time, beware of danger as the actuator may drop suddenly. Always provide a support to brace the actuator hand to prevent sudden drop, so as not to pinch fingers or damage the work part.

- 11) Check the following points before restoring the home position:
- The motor side should be aligned with the initial countermark.
 - The ball-screw side should be in a location corresponding to the slide position of 2 mm away from the mechanical end.
- After the check, attach a new belt while holding the pulleys on both sides in position.

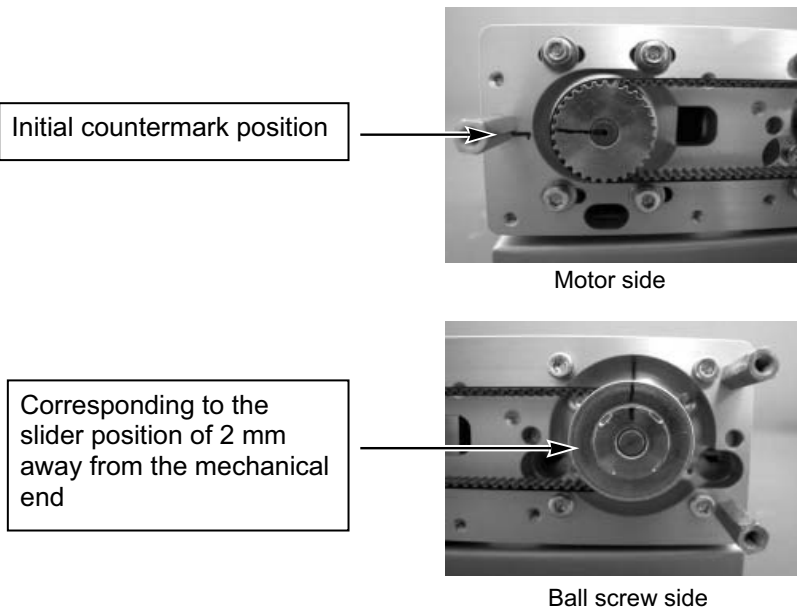

- 12) Adjust the belt tension.
Pass a looped strong string (or long tie-band) around the motor cover and pull it with a tension gauge to the specified tension. In this condition, uniformly tighten the motor-unit affixing bolts.

[Recommended tightening torque for adjustment bolts]
162 N·cm (16.5 kgf·cm)

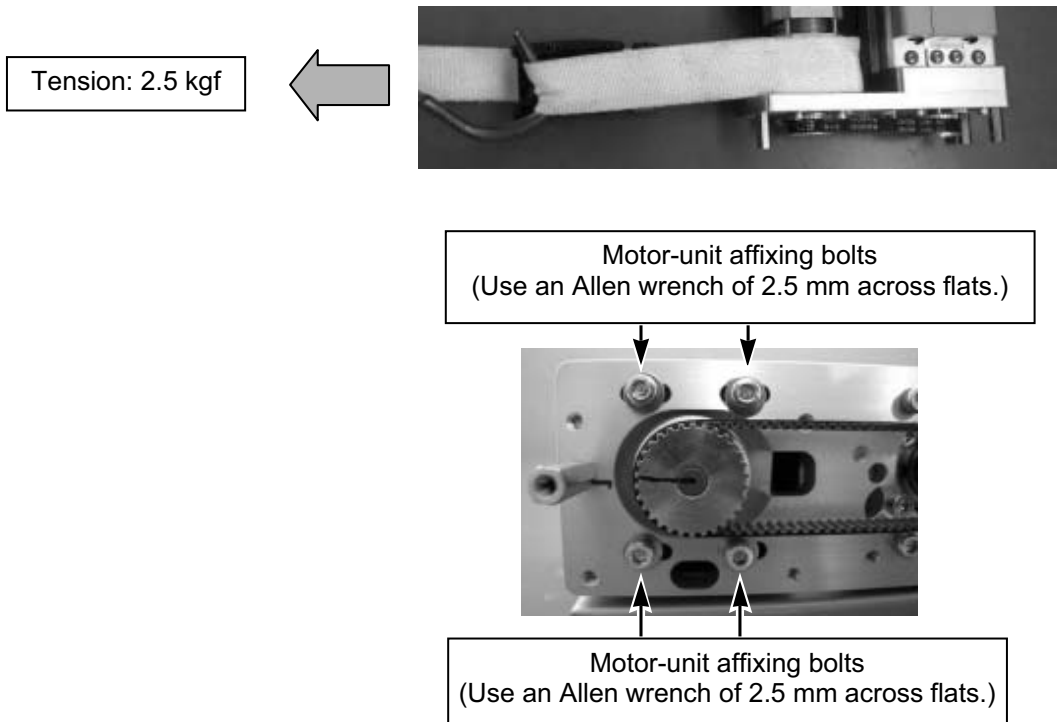

13) Install the attached cables.

- While holding the motor with one hand, insert the encoder cable. (The photograph bellow shows the motor (Encoder by IAI).)



- Install a grounding wire using a Phillips driver.

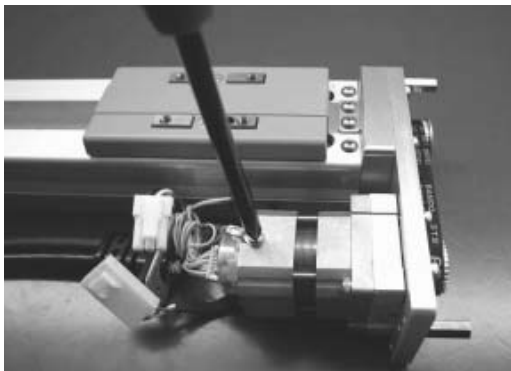

- Plug the cables into the motor.



- If the actuator has a brake, also plug in the brake connector.

- 14) Insert the motor-end cover and cap.



Pull out the cable end while pushing in the motor-end cap.

- 15) Use a Phillips screwdriver to securely tighten the affixing bolts for motor-end cap and attached cables.

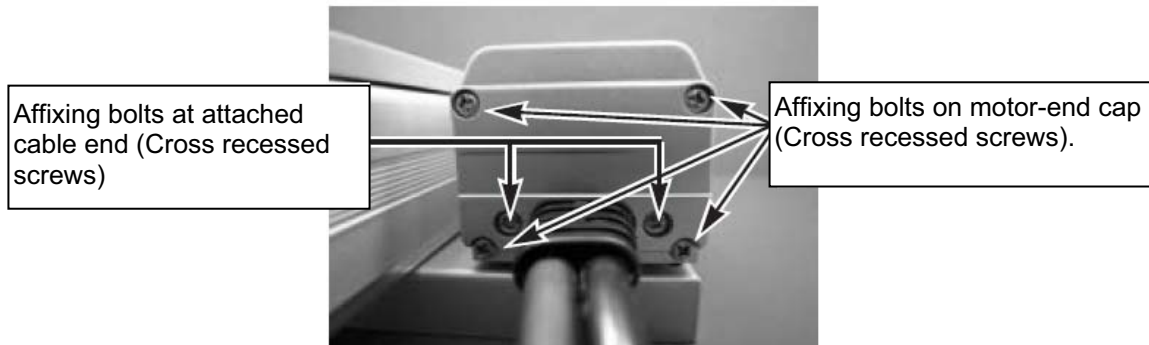

- 16) Use a Phillips screwdriver to securely tighten the affixing bolts for pulley cover.



Cross recessed screws: M3

- 17) Connect a PC or teaching pendant to the controller to perform homing. (If the actuator is of absolute encoder specification, an absolute reset must be performed.)
Check for deviation from the initial home position.
If there is a deviation when the SCON controller is being used, use home return offset distance of parameter No. 22 to make corrections. If the SSEL or the X-SEL controller is being used, use home preset value of axis-specific parameter No. 12 to make corrections.
For the absolute encoder specification, perform homing → absolute reset after changing the parameter.

11.10.6 Replacing the Motor of the Motor Reversing Type: RCS2-SA7R

[Items Required for Replacement]

- Replacement motor with pulley (See the photograph on the right) (Confirm that the motor has a countermark.)
- PC or teaching pendant
- Tension gauge (capable of tensioning to 8 kgf or greater)
- Strong string, looped (or long tie-band)
- Allen wrenches
- Phillips screwdrivers
- 5.5-mm spanner wrench or needle-nose pliers



[Overview of Replacement]

- 1) Remove the belt and replace the motor.
- 2) Restore the home position.
Press the slider against the mechanical end on the home side, and move the motor shaft away from the countermark by the specified distance. With the slider and motor shaft affixed in these positions, adjust the belt to the specified tension.
- 3) Perform homing using a PC or teaching pendant and check for deviation from the initial home position. If there is a deviation when the SCON controller is being used, use home return offset distance to make the adjustments. If the SSEL or the X-SEL controller is being used, use home preset value to make the adjustments.

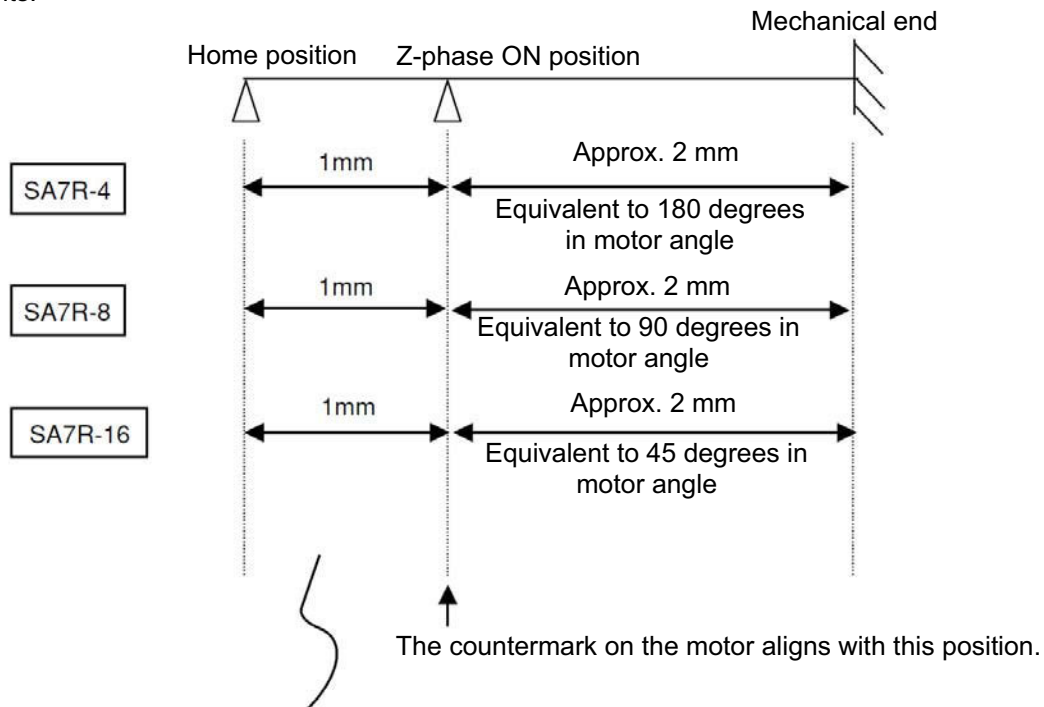

Use Parameter home return offset distance (SCON) or home preset value (SSEL and X-SEL) to specify the settings (The values displayed above are factory default settings).

[Procedure]

- 1) Move the slider from the home position toward the mechanical end and check the rotating direction of the motor. (This check is necessary, because the rotating direction of the motor is different on actuators whose home is set on the opposite side.)
 - Remove the pulley cover.
(Remove the four thin-head mounting screws using an Allen wrench.)

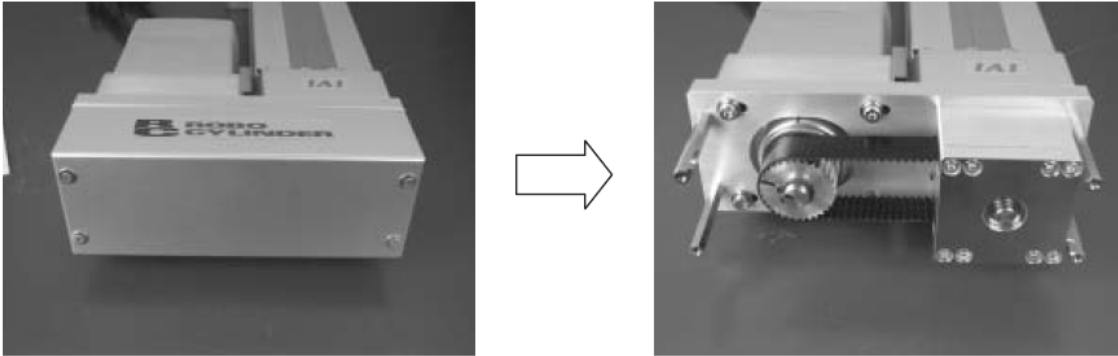

- 2) Loosen the four tension adjustment bolts and move the motor bracket to slack the belt.

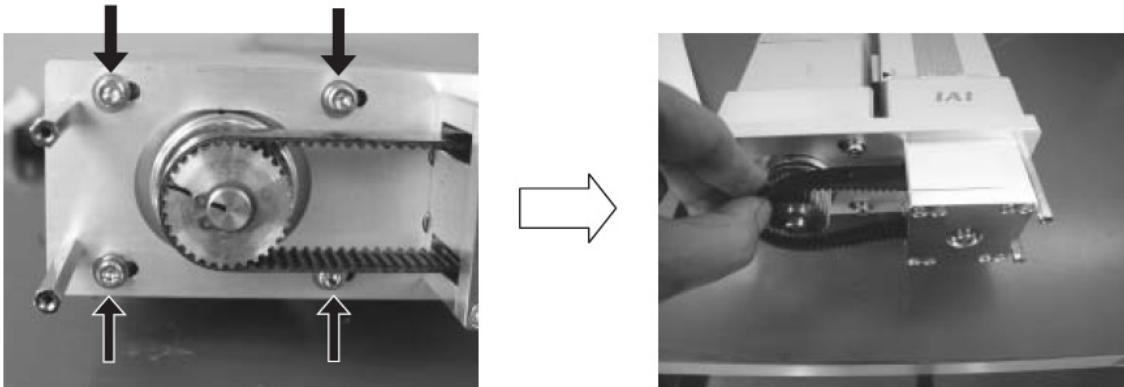

- 3) Remove the affixing the pulley cap and pulley housing, and remove the belt.

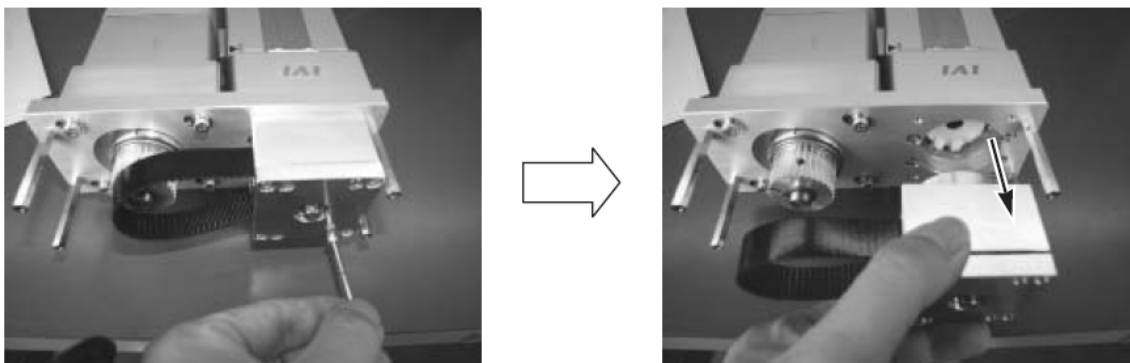

- 4) Remove the motor.
Remove the four hexagon socket-head bolts using an Allen wrench.

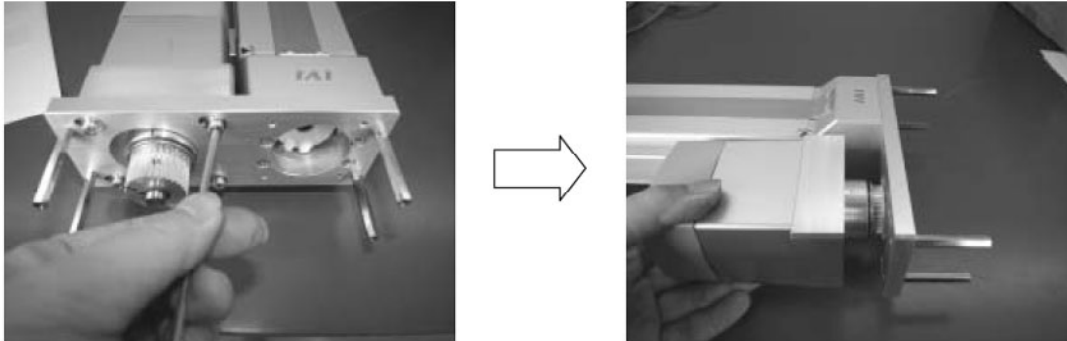

- 5) Install the new motor.
Loosely affix the four hexagon socket-head bolts (M4x20) using an Allen wrench of 3 mm across flats.

- 6) Install the pulley housing.
(Install the pulley housing by making sure the angle of the projection on the coupling matches the angle of the mating hole.)

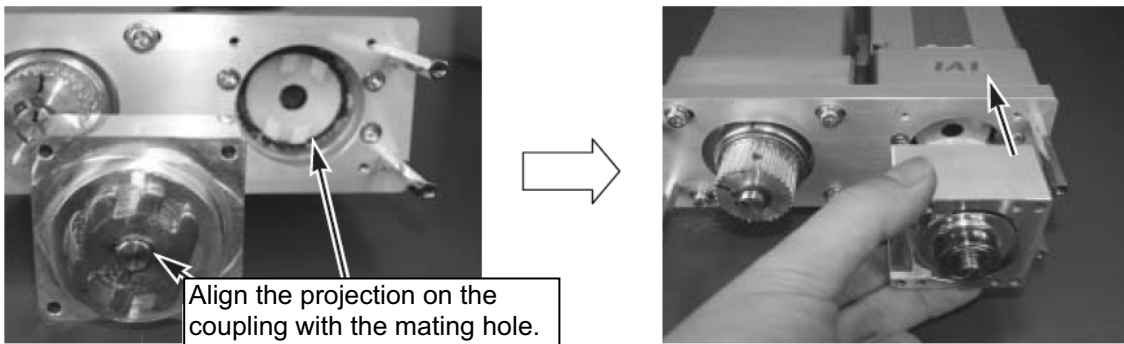

- 7) Make the adjustment to restore the home position.
- Press the slider against the mechanical end on the home side and affix the slider in this position.
 - Turn the motor shaft in the direction of returning to the mechanical end (direction of initial check) by the applicable amount, as specified in the table "Return Angle from Countermark Position," from the initial countermark position.

Example: When the return angle is 90 degrees

Initial countermark position

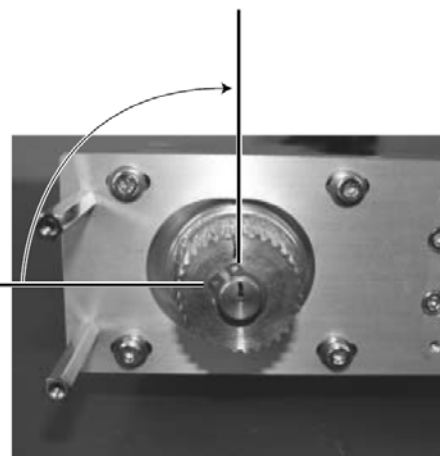

Type	Return angle from countermark position
SA7R-4	180 degrees
SA7R-8	90 degrees
SA7R-16	45 degrees

- 8) Adjust the belt tension.
Pass a looped strong string (or long tie-band) around the motor cover and pull it with a tension gauge to the specified tension. In this condition, uniformly tighten the adjustment bolts.

[Recommended tightening torque for adjustment bolts] (M4) 377 N·cm (38 kgf·cm)

Caution: Carefully tighten them to the specified torque by making sure the pulleys on both sides do not move.

Tension: $8 \text{ kgf} \pm 0.3 \text{ kgf}$ ←

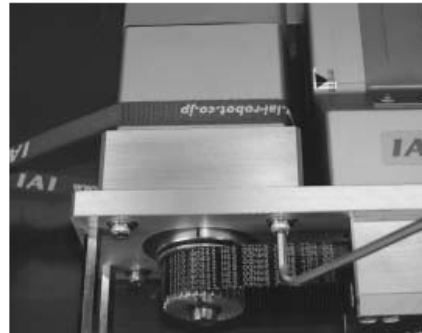

- 9) Install the pulley cover.
Tighten the four thin-head screws (M3x6) using an Allen wrench of 1.5 mm across flats.
- 10) Perform homing using a PC or teaching pendant.
(If the actuator is of absolute encoder specification, an absolute reset must be performed.)
Check for deviation from the initial home position.
If there is a deviation when the SCON controller is being used, use home return offset distance of parameter No. 22 to make corrections. If the SSEL or the X-SEL controller is being used, use home preset value of axis-specific parameter No. 12 to make corrections.
For the absolute encoder specification, perform homing → absolute reset after changing the parameter.

11.10.7 Replacing the Motor of the Motor Reversing Type: RCS3 (P)- SA8R, SS8R

[Items Required for Replacement]

- Replacement motor unit
- Allen wrenches
- Phillips screwdriver
- Sound-wave tension gauge or tension gauge (capable of withstanding at least 15 kg of tension)
- Long tie-band (thin string)
- Measuring tape
- Oil-based marker pen
- PC or teaching pendant

[Overview of Replacement]

- 1) Loosen the bolts securing the motor unit and replace the motor.
- 2) Restore the home position.
Fix the slider at a position 2 mm from the mechanical end on home side, pass the belt, and adjust the belt to the specified tension.
- 3) Perform homing using a PC or teaching pendant and check for deviation from the initial home position. If there is a deviation when the SCON controller is being used, use home return offset distance to make the adjustments. If the SSEL or the X-SEL controller is being used, use home preset value to make the adjustments.

[Procedure]

- 1) Remove the pulley cover.
Applicable wrench : 2 mm across flats
Applicable bolt : Hexagonal socket head bolt _M3 x 5 (SUS), 4 pcs



- 2) Remove the motor unit.
Applicable wrench : 3 mm across flats
Applicable bolt : Hexagonal socket head bolt _M4 x 16, 4 pcs

Washer : M4 flat washer, M4 spring washer #2

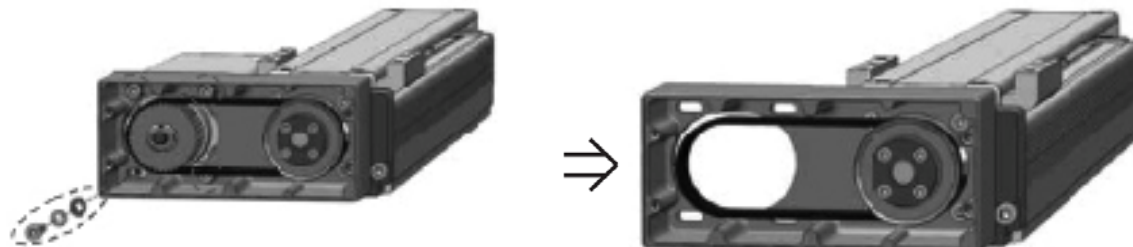

- 3) Mark the side cover at the "0 point (Z-phase ON)" position using the marker pen.
Press the slider against the mechanical end on home side and mark the side cover at the corresponding position using the marker pen.
From this position, move the actuator by 2 mm in the direction opposite home and mark again with the marker pen in the same manner.

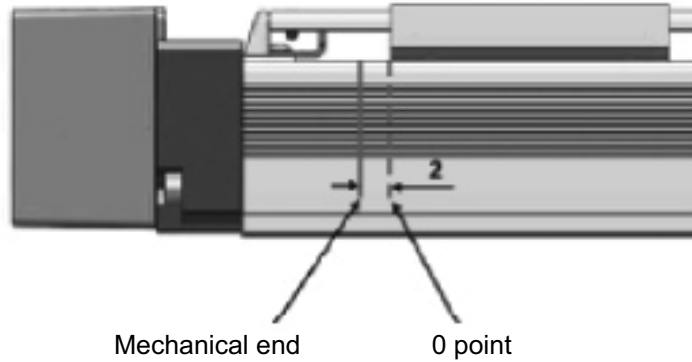

- 4) Loosen the bolts securing the power lock.
Applicable wrench : 2.5 mm across flats
Applicable bolt : Hexagonal socket head bolt M3 x 12. 4 pcs



After loosening the bolts, turn the pulleys by hand to move the slider toward the home until the slider contacts the mechanical end, and then turn the pulleys further to release the power lock on the pulleys and ball screws. (Now the slider should not move even when the pulleys are turned.)

- 5) Install the new motor unit.
Applicable wrench, bolt : Use the bolts and washers removed in 2).
- [1] Bring the slider to the 0 point you have marked earlier on the side cover.
[2] Align the countermarks on the pulley on motor unit side and the flange surface and pass the belt by guiding it through the oblong holes in the bracket.
(Turn the pulley on actuator side to adjust the angle until the pulley on motor unit side engages with the belt properly. When turning the pulley on actuator side, confirm that the slider is not moving.)
[3] Using the bolts and washers removed in 2), loosely secure the motor unit to the bracket.
[4] Actuate the power lock. Tighten the bolts at the four corners of the pressurization sleeve uniformly in a proper sequence until the gaps become uniform all around. [Tightening torque: 154 N·cm (15.8 kgf·cm)]

Try turning this pulley to the left and right to see if the motor unit slides.

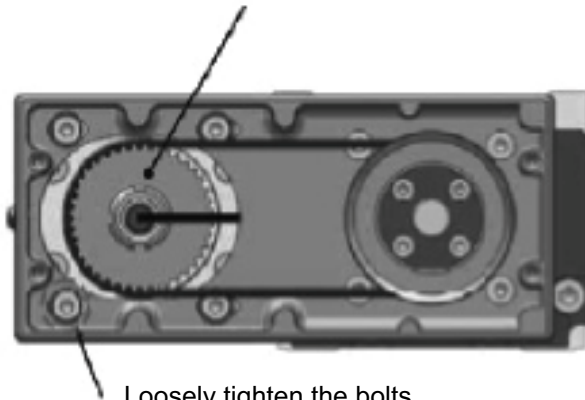

Loosely tighten the bolts.
Note: Tighten the bolts just enough to cause the surfaces to come in contact with each other as the motor unit slides.

6) Tension the belt.

- ◆ Here, two ways to tension the belts are explained: one using a sound-wave tension gauge (= tension method) and the other using a tension gauge (= pull method).
If the actuator is of the high-precision specification or used with the high acceleration/deceleration option, use of the tension method is recommended because the tension can be adjusted more accurately.

6)-1 Tension method

- [1] Remove the screw on the side face of the bracket on the motor reversing side.
Applicable screwdriver : Phillips (+)
Applicable screw : Crosshair socket pan-head machine screw M4 x 4 (SUS)

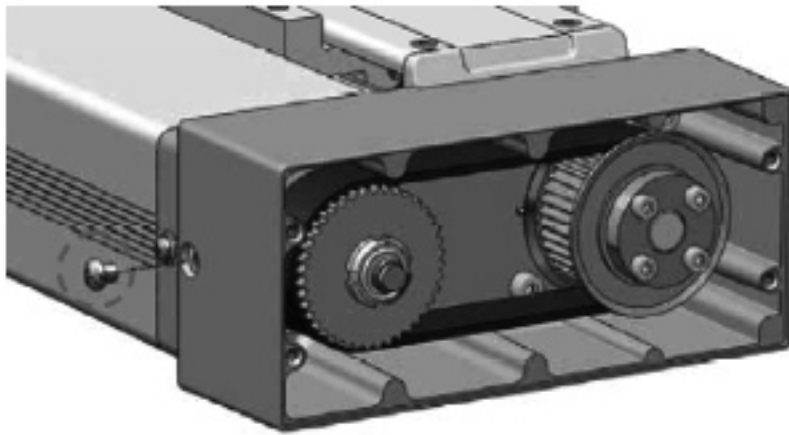

- [2] Have a hexagonal socket head bolt M3 x 15 ready as the tension bolt.
If no hexagonal socket head bolt M3 x 15 is available, remove one bolt of this size from the removed motor unit and use it as the tension bolt. (See the figure below.)

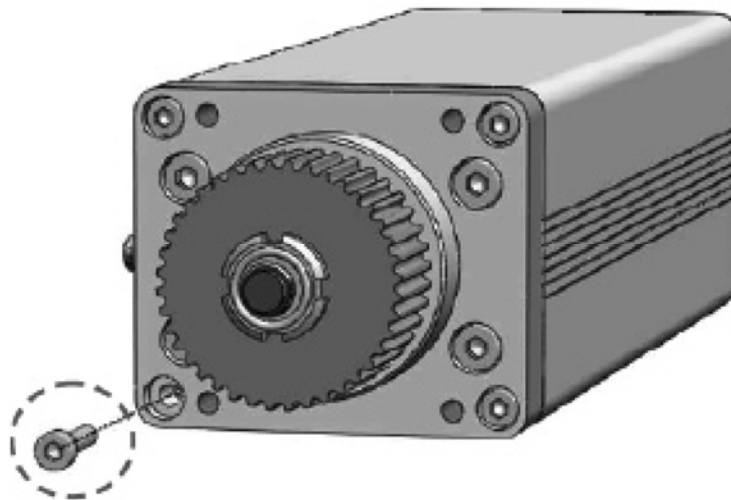

- [3] Guide the hexagonal socket head bolt M3 x 15 through the hole left by the screw in [1] until it engages with the tapped hole in the motor unit flange.

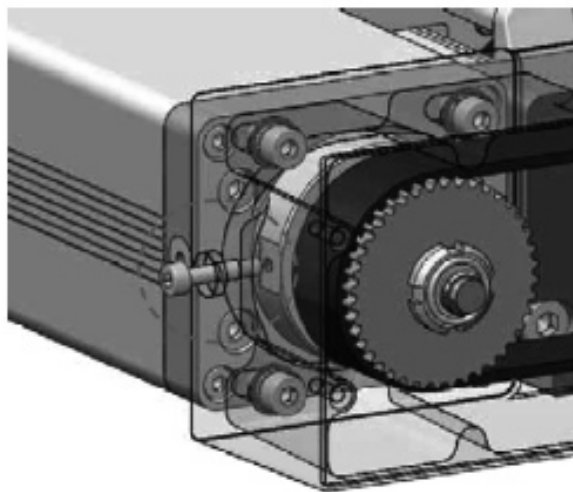

- [4] Turn the tension bolt to gradually apply tension. Once the gap between the motor unit and actuator becomes approx. 3 mm, measure the tension at the center of the belt span.

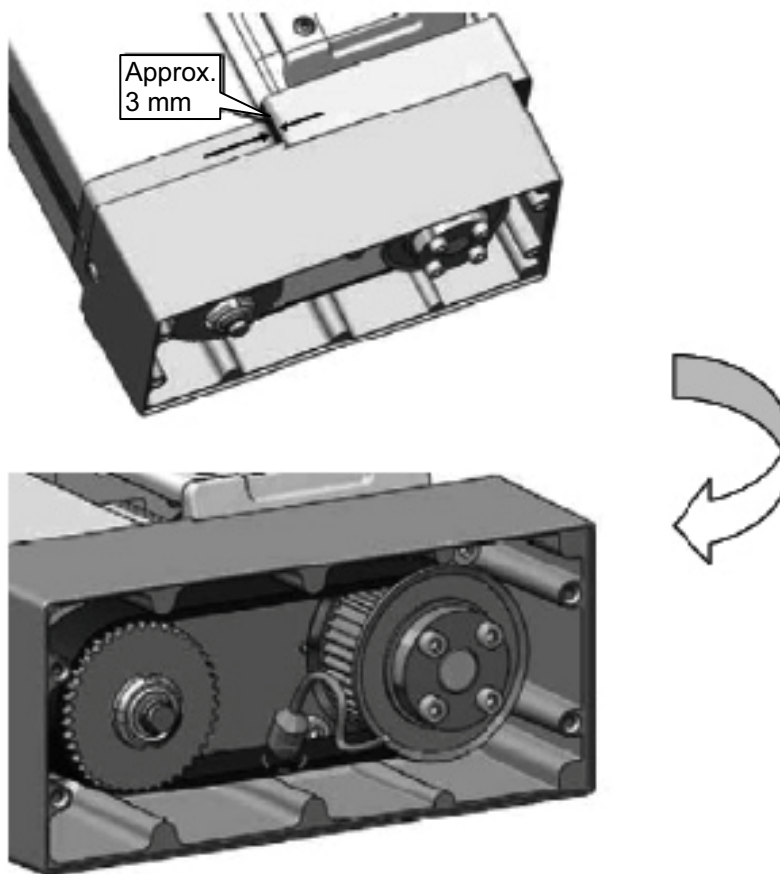

- * Set the sound-wave tension gauge according to the operation manual for the applicable gauge.
Setting items:

Belt unit mass = 1.8 [g/mm]
Belt width = 15 [mm]
Span = 74 [mm]

Tension: 55 to 60 [N]

- [5] Securely tighten the motor unit bolts.
Tightening torque: 176 N·cm (18 kgf·cm)
 - [6] Pull out the tension bolt and put the original screw back in to plug the hole.
- 6)-2 Pull method
- [1] Pass a long tie-band (thin string) over the motor unit and pull it with the tension gauge by applying the specified load.

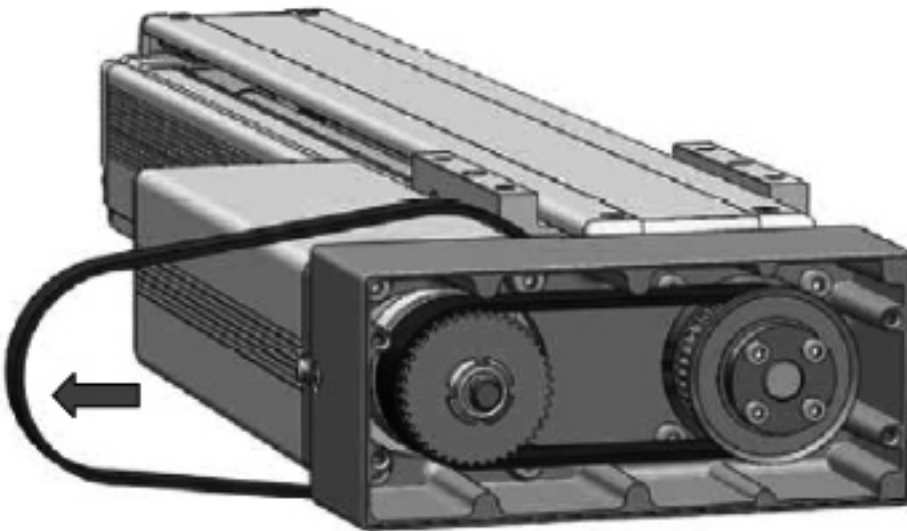

* Pulling load: 114 ± 5 [N]

- [2] Securely tighten the motor unit bolts.
Tightening torque: 176 N·cm (18 kgf·cm)
- 7) Secure the pulley cover in place. The motor has been replaced.

11.10.8 Replacing the Motor of the Motor Reversing Type: RCS2-SS7R, SS8R

[Items Required for Replacement]

- Replacement motor with pulley (See the photograph on the right) (Confirm that the motor has a countermark.)
- PC or teaching pendant
- Tension gauge (capable of tensioning to 7 kgf or greater)
- Strong string, looped (or long tie-band)
- Allen wrenches
- Phillips screwdrivers
- 5.5-mm spanner wrench or needle-nose pliers

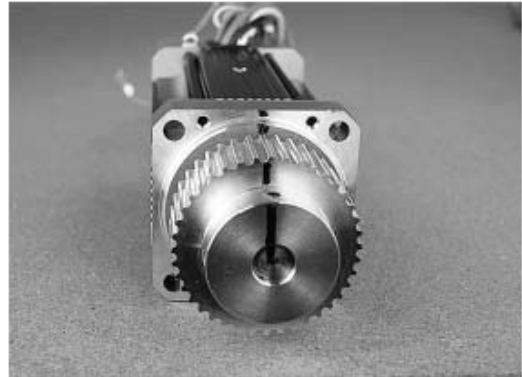

[Overview of Replacement]

- 1) Remove the belt and replace the motor.
- 2) Restore the home position.

Press the slider against the mechanical end on the home side, and move the motor shaft away from the countermark by the specified distance. With the slider and motor shaft affixed in these positions, adjust the belt to the specified tension.

- 3) Perform homing using a PC or teaching pendant and check for deviation from the initial home position. If there is a deviation when the SCON controller is being used, use home return offset distance to make the adjustments. If the SSEL or the X-SEL controller is being used, use home preset value to make the adjustments.

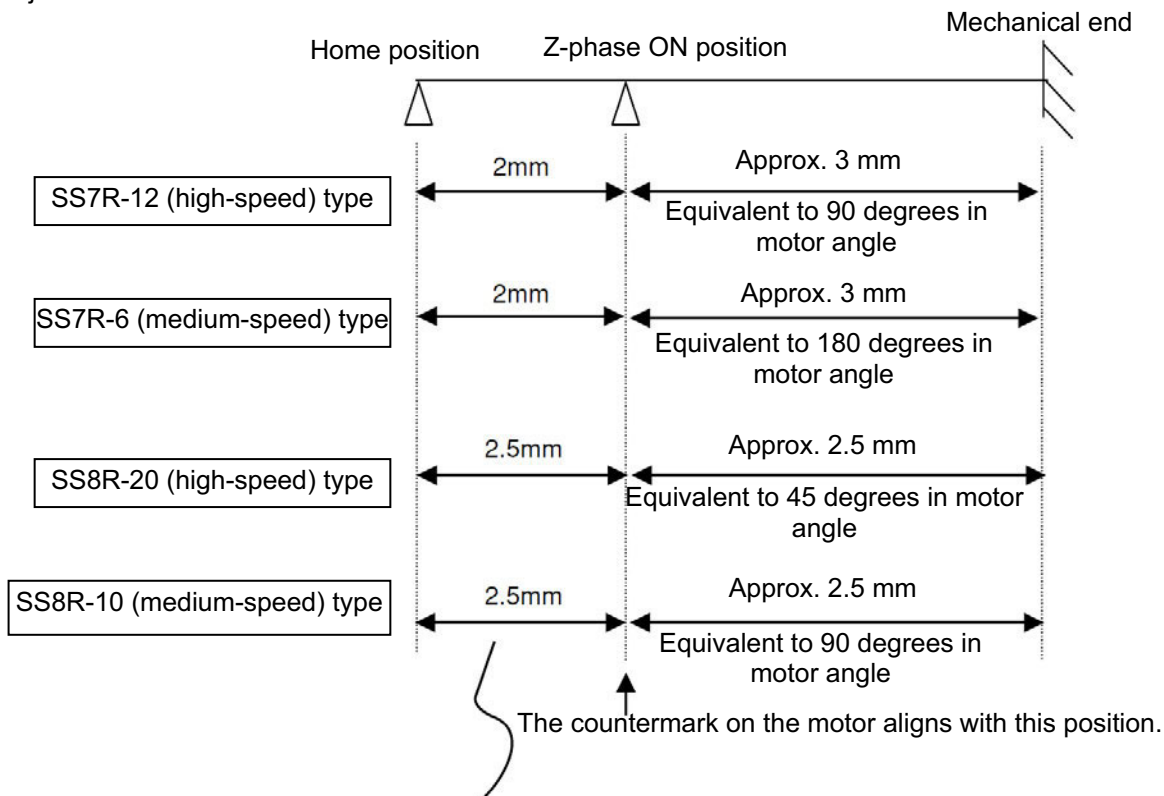

Use Parameter home return offset distance (SCON) or home preset value (SSEL and X-SEL) to specify the settings (The values displayed above are factory default settings).

[Procedure]

1) Move the slider from the home position toward the mechanical end and check the rotating direction of the motor. (This check is necessary, because the rotating direction of the motor is different on actuators whose home is set on the opposite side.)

- Remove the pulley cover. (Remove the three thin-head mounting screws using an Allen wrench of 1.5 mm across flats for SS7R and of 2 mm across flats for SS8R.)
- Check the rotating direction of the motor shaft.

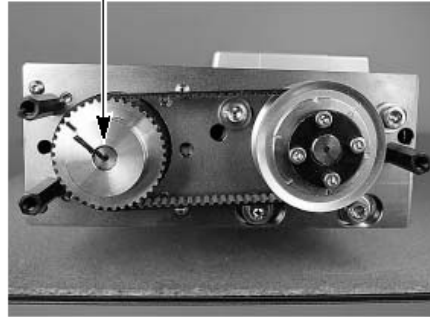

2) Loosen the tension adjustment bolts and move the motor bracket to slack and remove the belt.

Tension adjustment bolts
(Use an Allen wrench of 3 mm across flats for SS7R and of 4 mm across flats for SS8R.)

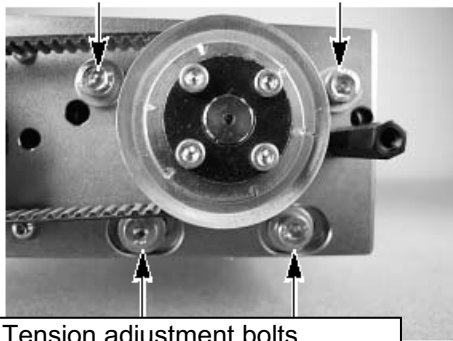

Tension adjustment bolts
(Use an Allen wrench of 3 mm across flats.)

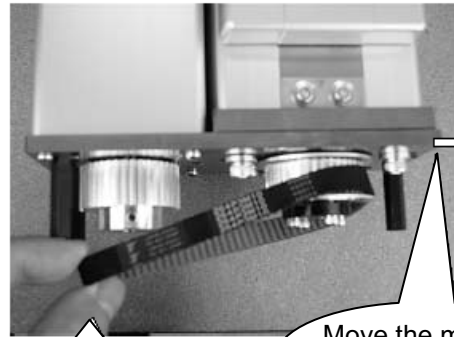

Remove by hand.

Move the motor bracket.

3) Remove the motor-end cap.
(Remove the four thin-head screws using an Allen wrench of 1.5 mm across flats.)

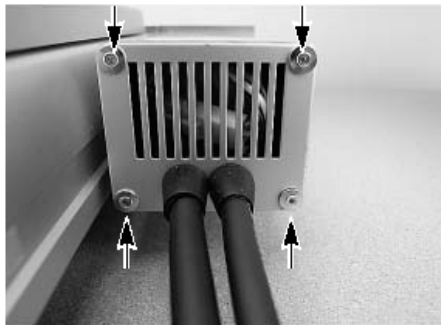

4) Pull out the relay connectors for the attached cables.

- Motor connector
- Encoder connector



- If the actuator is equipped with a brake, also remove the brake connector.

5) Remove the grounding and shield wires, and separate the attached cables.

- Loosen the nut using a Phillips screwdriver and a 5.5-mm spanner wrench (or needle-nose pliers).

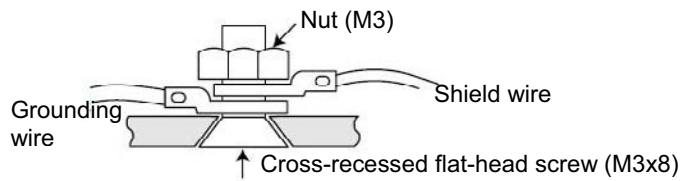
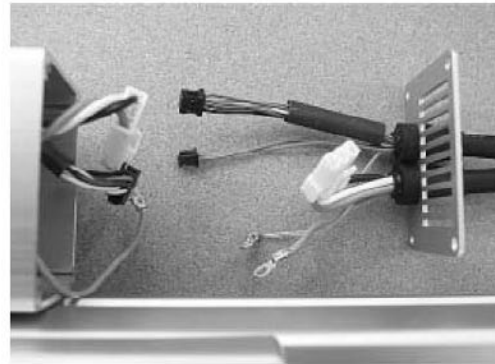
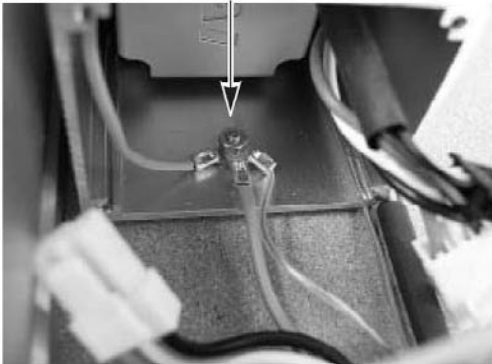

6) Remove the motor cover.

Remove the four hexagon socket-head button bolts using an Allen wrench of 2 mm across flats.

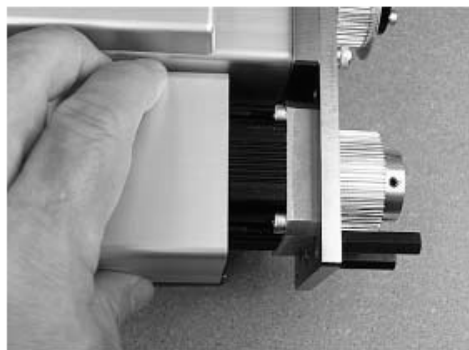
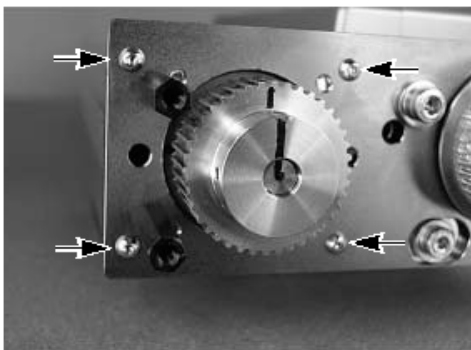

- 7) Remove the motor.
Remove the four hexagon socket-head bolts using an Allen wrench of 3 mm across flats.

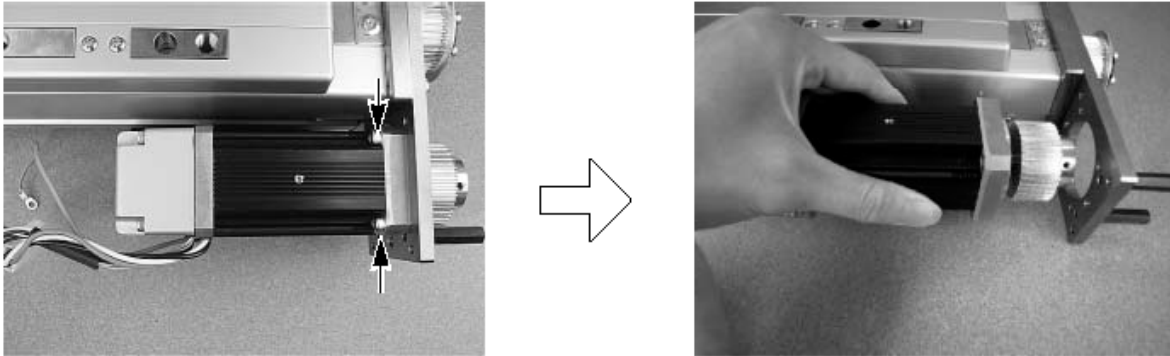

- 8) Install the new motor.
Tighten the four hexagon socket-head bolts (M4x15) uniformly using an Allen wrench of 3 mm across flats.
Recommended tightening torque: 176 N·m (18 kgf·cm)

- 9) Install the motor cover.
Tighten the four hexagon socket-head button bolts (M3x12) using an Allen wrench of 2 mm across flats.
- 10) Connect the relay connectors for the attached cables, grounding wires etc., back to their original conditions.
- Affix the two grounding wires and one shield wire using the flat-head screw and nut.
 - Connect the relay connectors.

- 11) Install the motor-end cap.
Tighten the four thin-head screws (M3x6) using an Allen wrench of 1.5 mm across flats.
Caution: Check the storage of cables carefully to make sure the cables are not pinched.

- 12) Make the adjustment to restore the home position.
- Press the slider against the mechanical end on the home side and affix the slider in this position.
 - Turn the motor shaft in the direction of returning to the mechanical end (direction of initial check) by the applicable amount, as specified in the table “Return Angle from Countermark Position,” from the initial countermark position.
- Example for SS7R-12/SS8R-10 types:
Turn 90 degrees in the direction of returning to the mechanical end (standard home specification).

Initial countermark position

Type	Return angle from countermark position
SS7R-12 (high speed)	90 degrees
SS7R-6 (medium speed)	180 degrees
SS8R-20 (high speed)	45 degrees
SS8R-10 (medium speed)	90 degrees

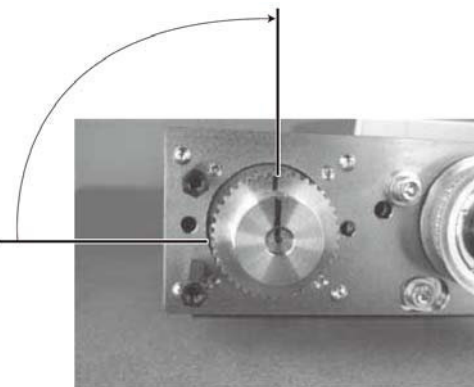

- Pass the new belt by making sure the pulleys on both sides do not move.

- 13) Adjust the belt tension.
Pass a looped strong string (or long tie-band) around the motor cover and pull it with a tension gauge to the specified tension. In this condition, uniformly tighten the adjustment bolts.
Recommended tightening torque for adjustment bolts
SS7R: 2 upper bolts (M4) 377 N·cm (38 kgf·cm) SS8R: 2 upper bolts (M5) 763 N·cm (78 kgf·cm)
 2 lower bolts (M4) 377 N·cm (38 kgf·cm) 2 lower bolts (M4) 763 N·cm (78 kgf·cm)

Caution: Carefully tighten them to the specified torque by making sure the pulleys on both sides do not move.

Tension: SSR: 6.7 kgf
 SMR: 6.9 kgf



- 14) Install the pulley cover.
With SS7R, tighten the three thin-head screws (M3x6) using an Allen wrench of 1.5 mm across flats. With SS8R, tighten the three thin-head screws (M4x6) using an Allen wrench of 2 mm across flats.
- 15) Perform homing using a PC or teaching pendant.
(If the actuator is of absolute encoder specification, an absolute reset must be performed.)
Check for deviation from the initial home position.
If there is a deviation when the SCON controller is being used, use home return offset distance of parameter No. 22 to make corrections. If the SSEL or the X-SEL controller is being used, use home preset value of axis-specific parameter No. 12 to make corrections.
For the absolute encoder specification, perform homing → absolute reset after changing the parameter.

11.10.9 Replacing the Motor of the Motor Straight Type (Coupling Type) : RCS3 (P)-SA8C, RCS3 (P) CR-SA8C

[Items Required for Replacement]

- Replacement motor
- Allen wrenches
- Phillips screwdriver
- Scale
- Oil-based marker pen
- PC or teaching pendant

Replacement motor



Caution: When replacing the motor, handle the replacement motor with due care. The actuator has been shipped with the encode adjusted to an optimal position, so do not crush the encoder unit. It may displace the encoder, thus impairing proper actuator operation.

[Overview of Replacement]

- 1) Move the slider to a position where Z-phase turns on (home position) (2 mm from the mechanical end). Replace the motor in this position.
- 2) Perform homing using a PC or teaching pendant and check for deviation from the initial home position. If there is a deviation when the SCON controller is being used, use home return offset distance to make the adjustments. If the SSEL or the X-SEL controller is being used, use home preset value to make the adjustments.

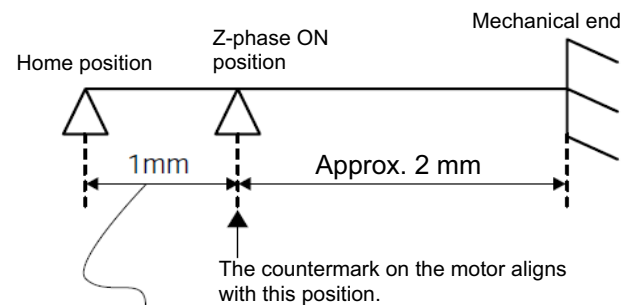

Use Parameter home return offset distance (SCON) or home preset value (SSEL and X-SEL) to specify the settings
(The values displayed above are factory default settings).

[Procedure]

- 1) Use an Allen wrench of 2 mm across flats to remove the screws and take out the cover.

[RCS3-SA8C]

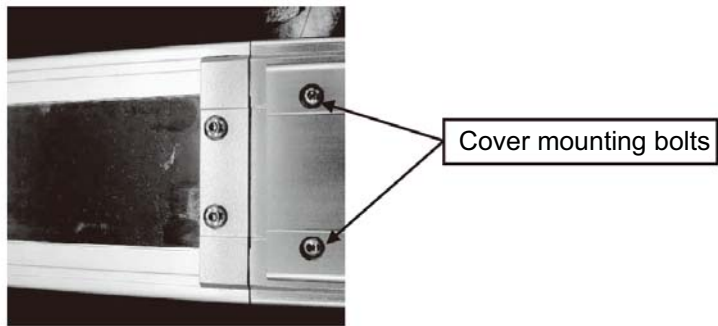
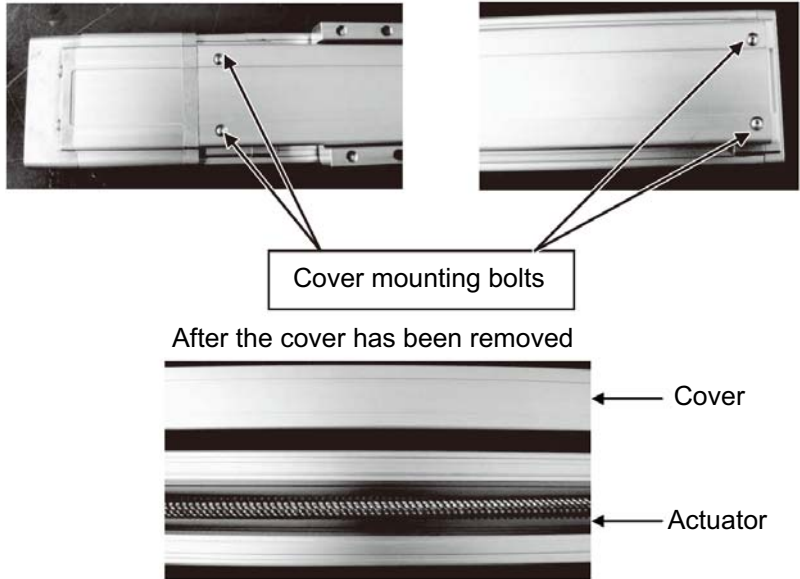

After the cover has been removed



- 2) Move the slider to a position where Z-phase turns on (home position).
On both standard actuators and actuators whose home is set on the opposite side, this position corresponds to 2 mm from the mechanical end.

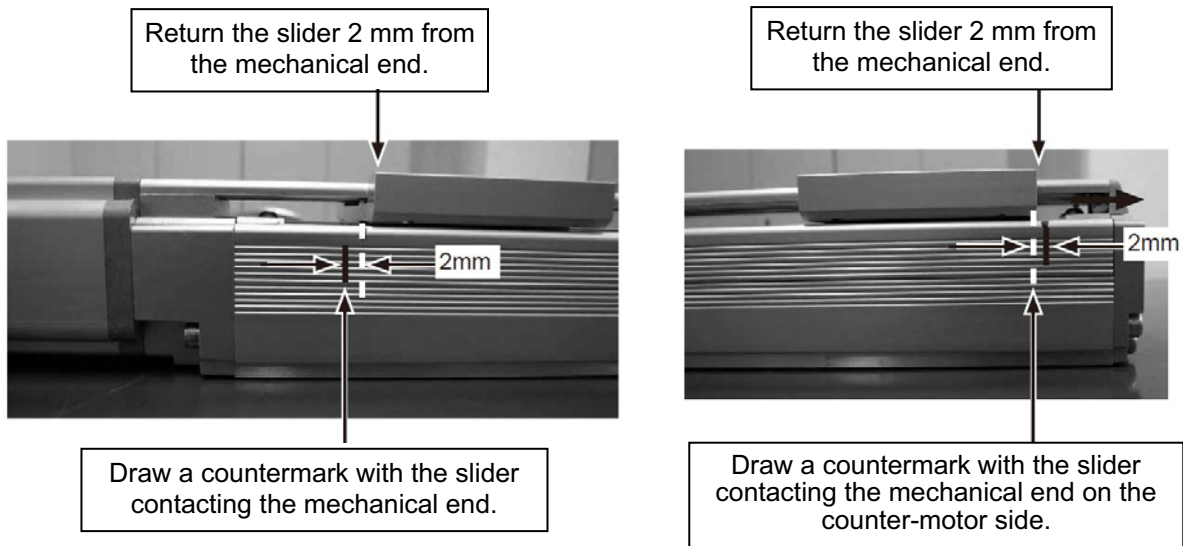

Warning: If the actuator is installed vertically, move it after turning on the controller power and forcibly releasing the brake. At this time, beware of danger as the actuator may drop suddenly. Always provide a support to brace the actuator hand to prevent sudden drop, so as not to pinch fingers or damage the work part.

- 3) Use an Allen wrench of 2.5 mm across flats to remove the bolts affixing the motor end cap. Use a screwdriver to remove the ground terminal bolt.

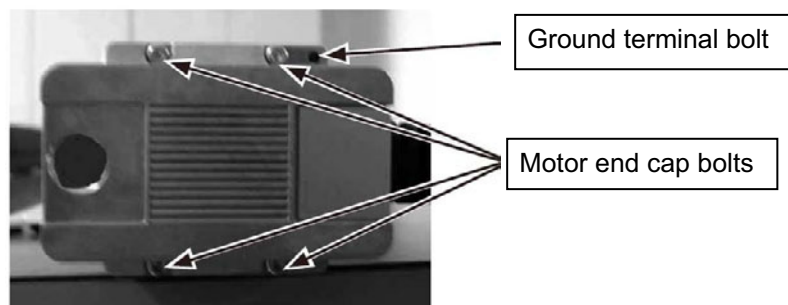

4) Pull out the motor-end cap.

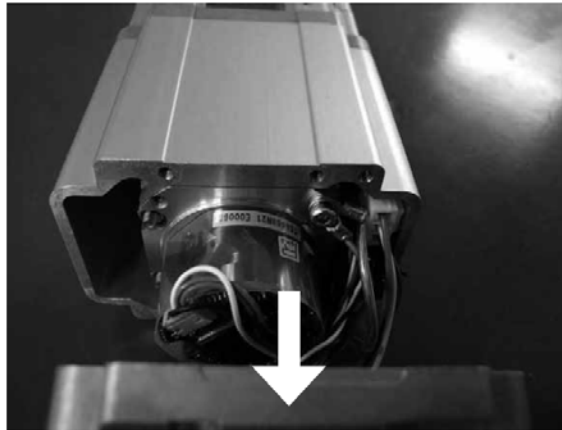

5) Pull out the motor-end cover to expose the motor.



 Caution: Caution: Never touch the encoder. Doing so may cause the encoder position to shift, in which case the encoder will no longer operate properly.

- 6) Detach the attached cables.
Use an Allen wrench of 2.5 mm across flats to disconnect the ground wire.

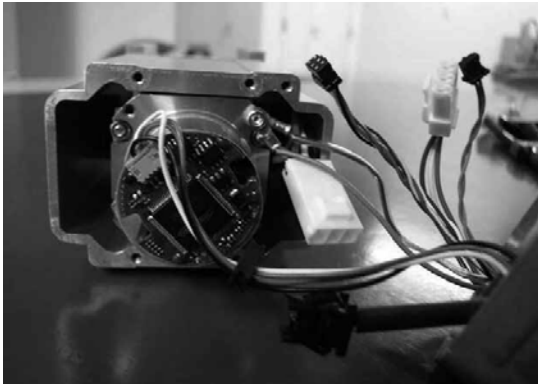

- 7) Use an Allen wrench of 2.5 mm across flats to loosen the coupling screws on the motor end.

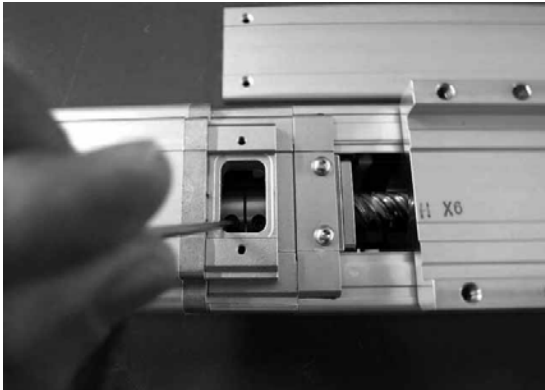

- 8) Use an Allen wrench of 3.0 mm across flats to remove the motor screws.

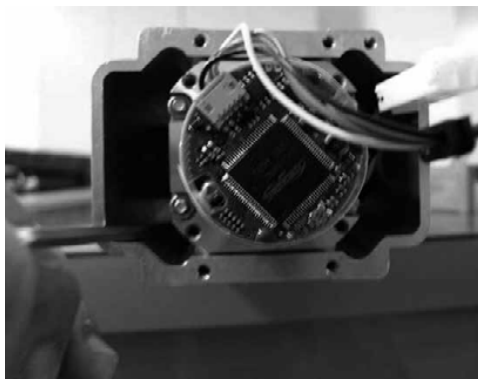

9) Take out the motor.

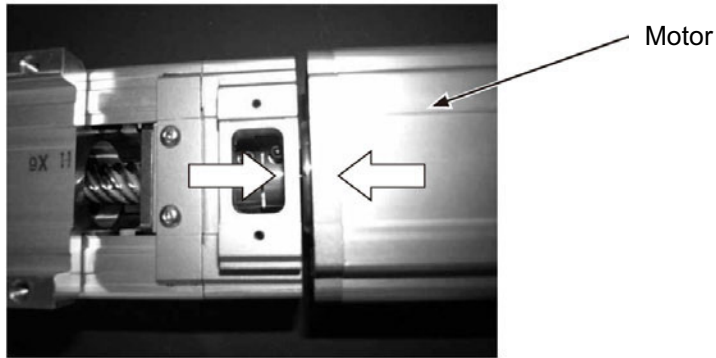

10) Check if the countermarks are aligned on the replacement motor. If not, align the countermarks.

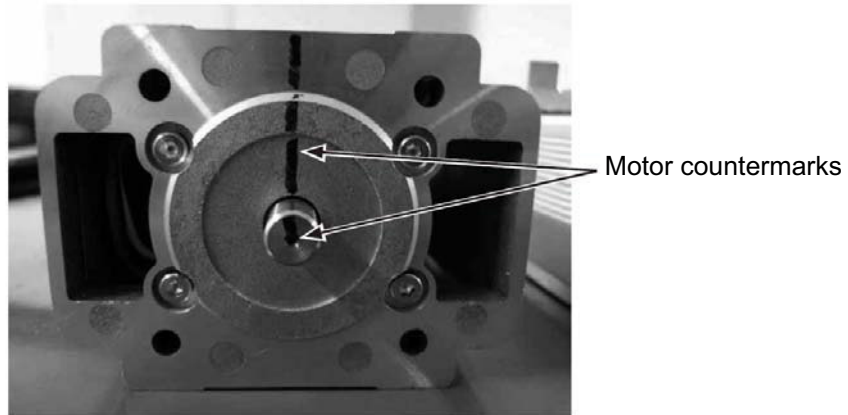

11) Pull out the end cap of the replacement motor.

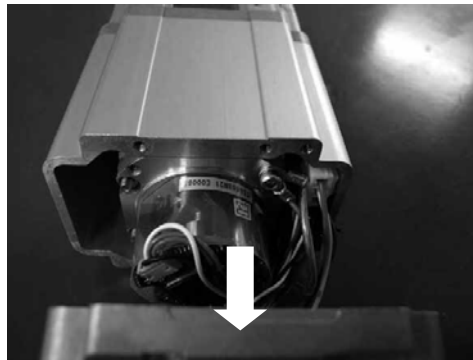

- 12) Once the end cap of the replacement motor has been pulled out, the motor is exposed.

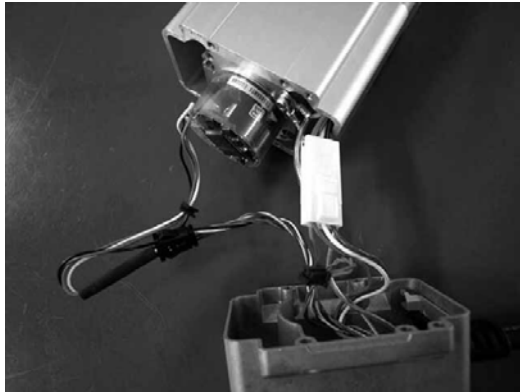

 **Caution:** Caution: Never touch the encoder. Doing so may cause the encoder position to shift, in which case the encoder will no longer operate properly.

- 13) Remove the supplied cable of the replacement motor.
Use an Allen wrench of 2.5 mm across flats to disconnect the ground wire.

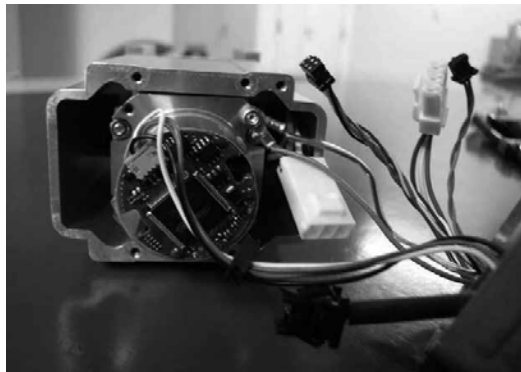

- 14) Install the replacement motor by aligning the cable direction.

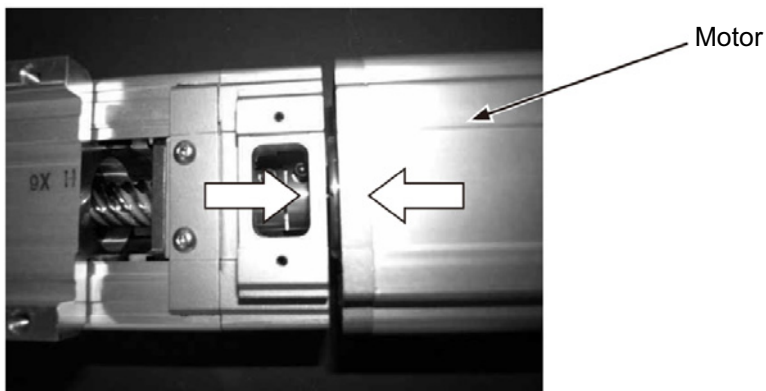

- 15) Use an Allen wrench of 3.0 mm across flats to loosely tighten the motor screws. (Tighten the screws by hand until they are roughly secured.)

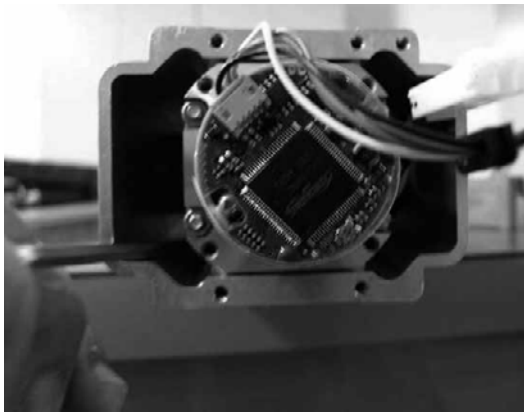

- 16) With the motor loosely secured, use an Allen wrench of 2.5 mm across flats to tighten the coupling screws on the motor end.

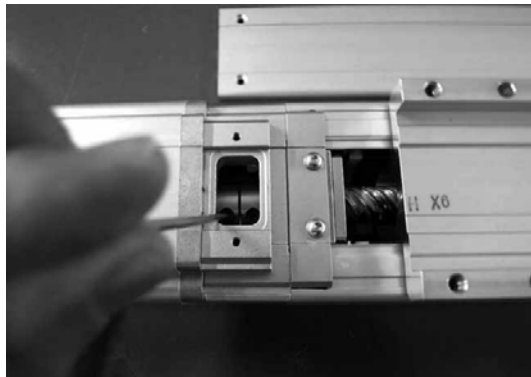

Tightening Torque : 150N · cm (15.3kgf · cm)

- 17) Loosen the screws you have only loosely tightened, move the slider back and forth 3 to 4 times by hand (over as long an operation stroke as possible), move the slider to near the mechanical end on the motor side, and once the slider is at a position where the motor vibration becomes the smallest, securely tighten the screws on the motor unit.

Use an Allen wrench of 3.0 mm across flats to tighten the motor screws.

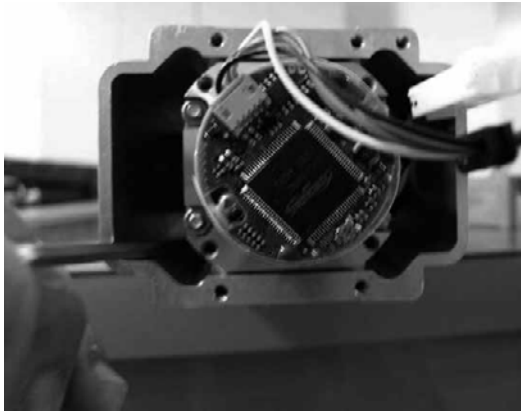

Tightening Torque : 176N · cm (18.0kgf · cm)

- * If the actuator has a brake, connect the encoder cable, plug in only the connector on the brake lead wire, and turn on the controller power. Next, release the brake and move the slider. To ensure safety, secure the motor unit before canceling the break release switch, and then turn off the controller power and unplug the connector on the encoder cable.

- 18) Use an Allen wrench of 2.5 mm across flats to connect the ground wire. Plug in the connector.



Tightening Torque : 83N · cm (8.47kgf · cm)

19) Install the motor end cap of the replacement motor.

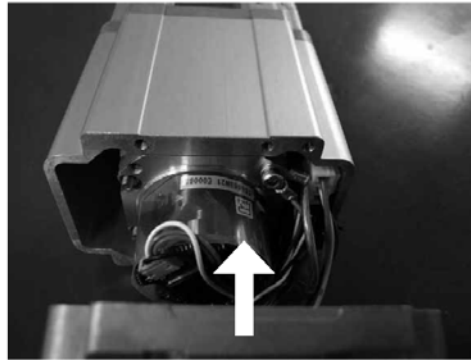

20) Use an Allen wrench of 2 mm across flats to tighten the motor end cap bolts.
Use a screwdriver to tighten the ground terminal bolt.

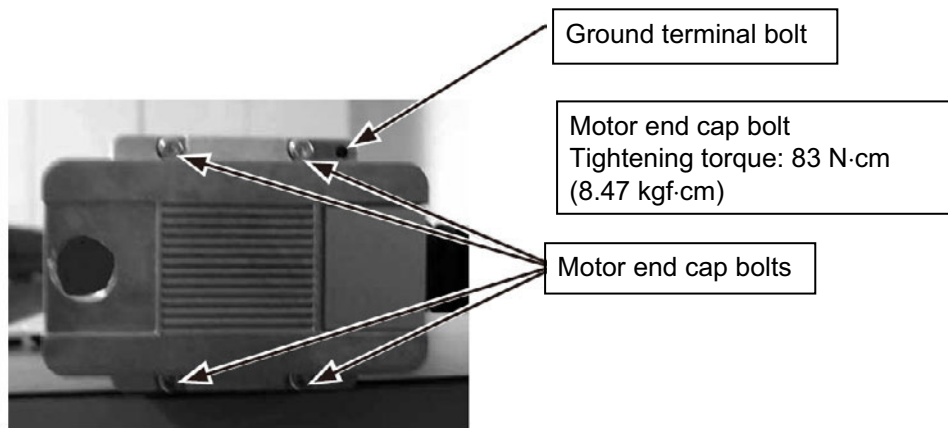

21) Use an Allen wrench of 2 mm across flats to tighten the screws and install the cover.

[RCS3-SA8C]

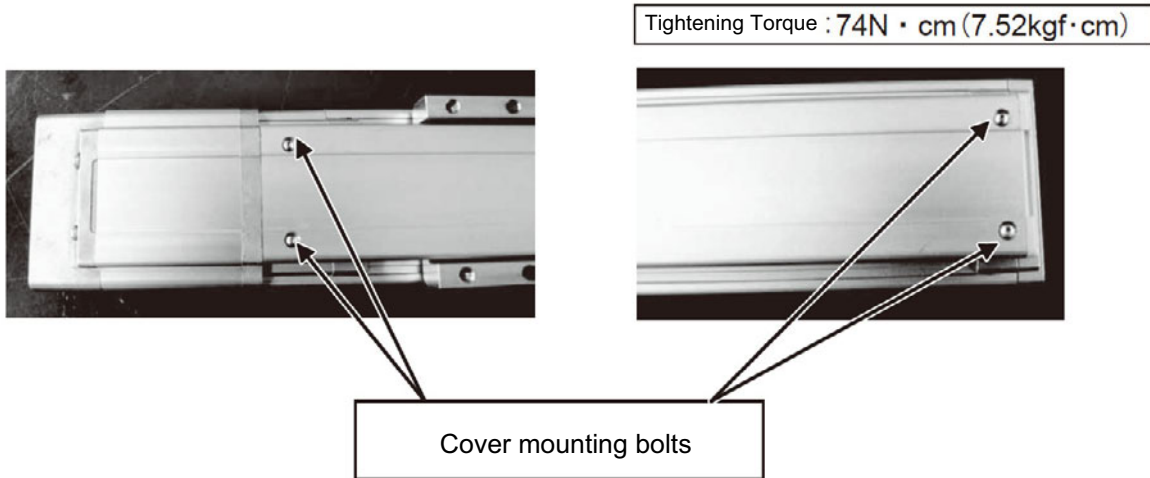

[RCS3CR-SA8A]

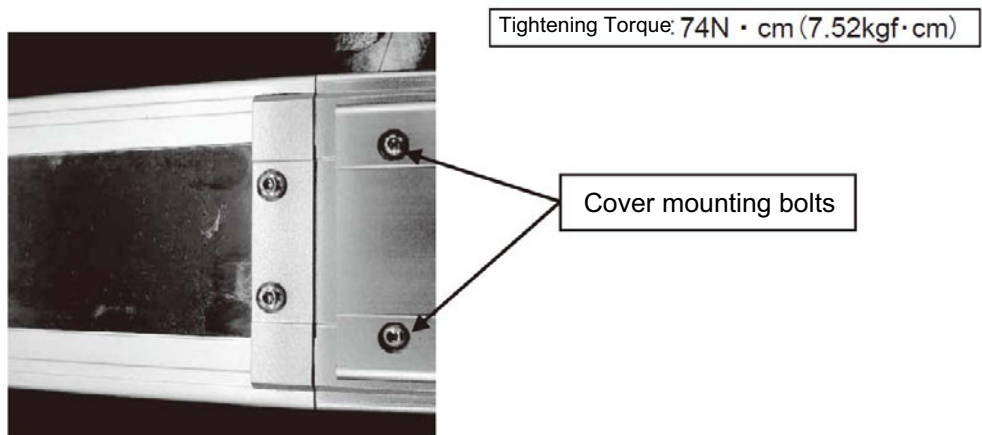

11.10.10 Replacing the Motor of the Motor Straight Type (Coupling Type) : RCS3 (P)-SS8C

[Items Required for Replacement]

- Replacement motor
- Allen wrenches
- Phillips screwdriver
- Scale
- Oil-based marker pen
- PC or teaching pendant

Replacement motor



Caution: When replacing the motor, handle the replacement motor with due care. The actuator has been shipped with the encode adjusted to an optimal position, so do not crush the encoder unit. It may displace the encoder, thus impairing proper actuator operation.

[Overview of Replacement]

- 1) Move the slider to a position where Z-phase turns on (home position) (2 mm from the mechanical end). Replace the motor in this position.
- 2) Perform homing using a PC or teaching pendant and check for deviation from the initial home position. If there is a deviation when the SCON controller is being used, use home return offset distance to make the adjustments. If the SSEL or the X-SEL controller is being used, use home preset value to make the adjustments.

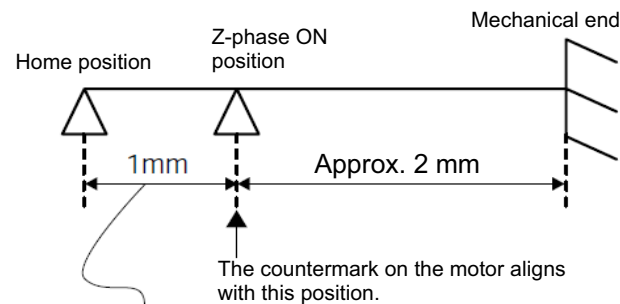

Use Parameter home return offset distance (SCON) or home preset value (SSEL and X-SEL) to specify the settings
(The values displayed above are factory default settings).

[Procedure]

- 1) Remove the screws and take out the slider cover.
After the slider cover has been removed

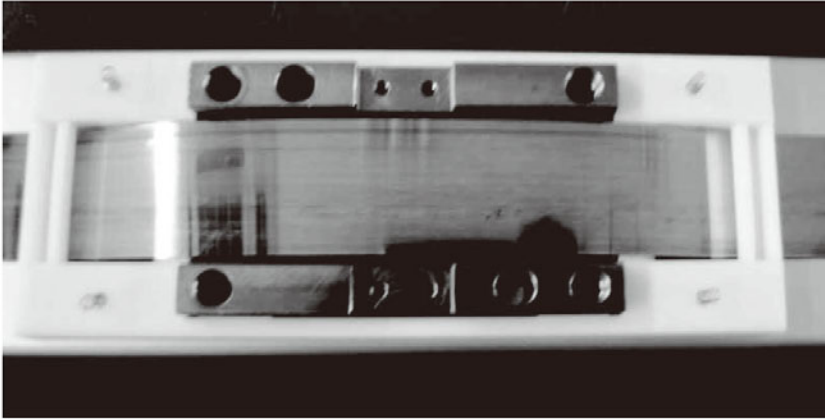

- 2) Use an Allen wrench of 2 mm across flats to remove the two screws and take out the stainless sheet on the motor end.

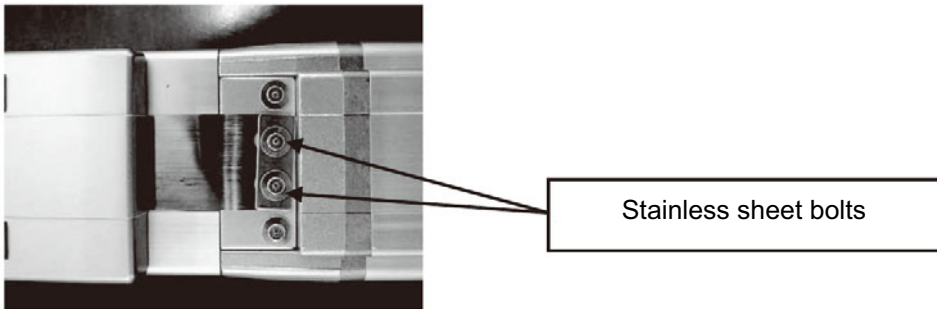

- 3) Remove the sheet slider from the slider, and then loop the stainless sheet and secure one side with tape, etc.

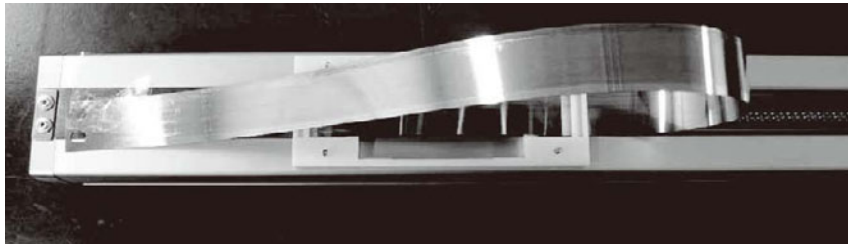

- 4) Move the slider to a position where the sensor at Z-phase, which defines the home, turns ON. With both the standard specification and reversed-home specification, this is where the slider has been returned by 2 mm from the mechanical end.

Return the slider by 2 mm from the mechanical end.

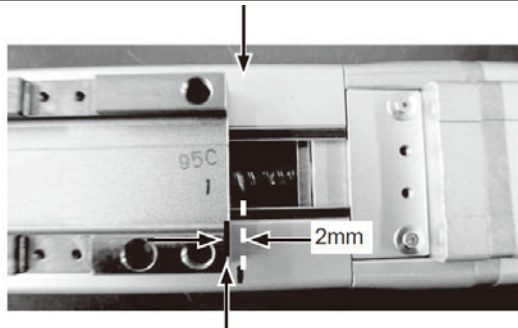

Press the slider against the mechanical end and draw countermarks.



Warning: In the case of a vertical axis, turn on the controller power and then forcibly release the brake to move the actuator. Take note, however, that the actuator may drop suddenly as the brake is released, in which case a dangerous situation may result.

Be sure to provide a base to support the robot hand and take other appropriate measures to prevent it from dropping suddenly, to keep your hands from getting pinched or work part from damaged.

- 5) Use an Allen wrench of 2 mm across flats to remove the two screws and take out the cover so that the motor coupling is exposed.



Cover mounting bolts

After the cover has been removed

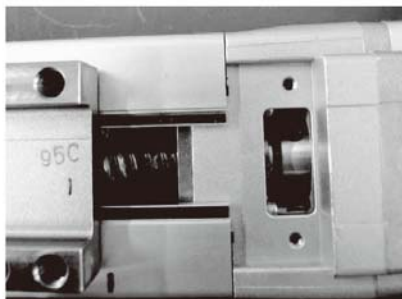

- 6) Use an Allen wrench of 2.5 mm across flats to remove the motor end cap bolts.
Use a screwdriver to remove the ground terminal bolt.

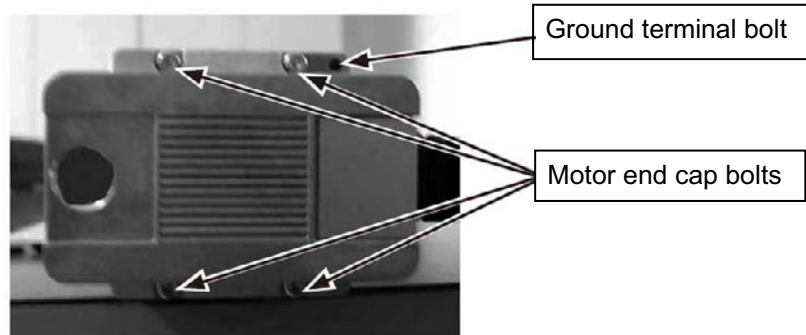

- 7) Pull out the motor-end cap.

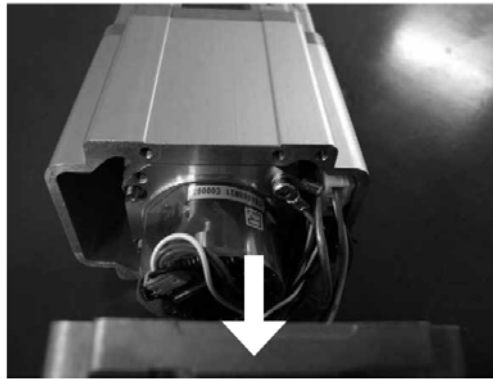

- 8) Pull out the motor-end cover to expose the motor.

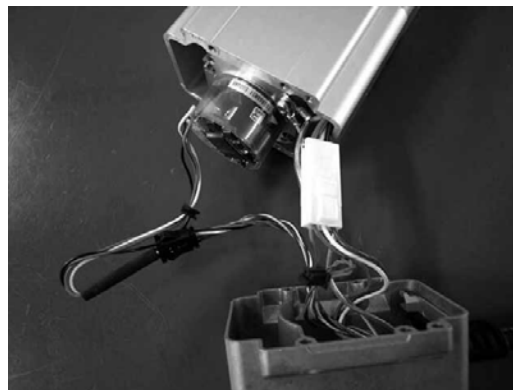

Caution: Caution: Never touch the encoder. Doing so may cause the encoder position to shift, in which case the encoder will no longer operate properly.

- 9) Detach the attached cables.
Use an Allen wench of 2.5 mm across flats to disconnect the ground wire.

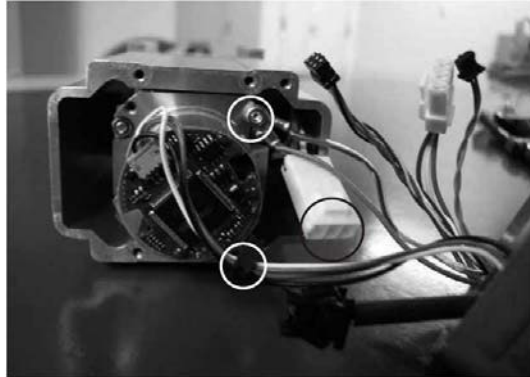

- 10) Use an Allen wench of 2.5 mm across flats to loosen the coupling screws on the ball screw end.

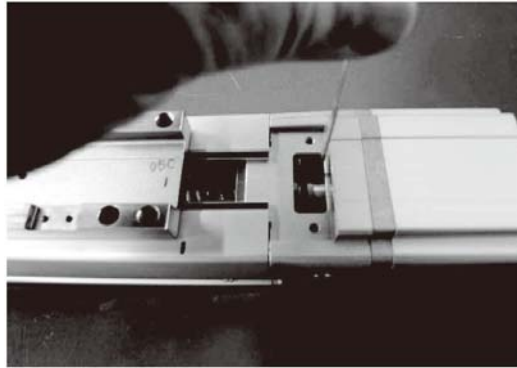

- 11) Use an Allen wench of 3.0 mm across flats to remove the motor screws.

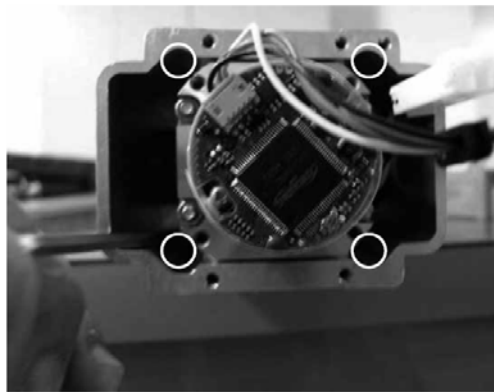

12) Detach the attached cables.

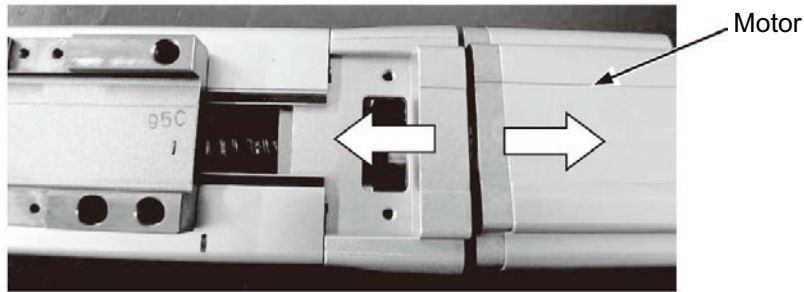

13) Check if the countermarks are aligned on the replacement motor. If not, align the countermarks.

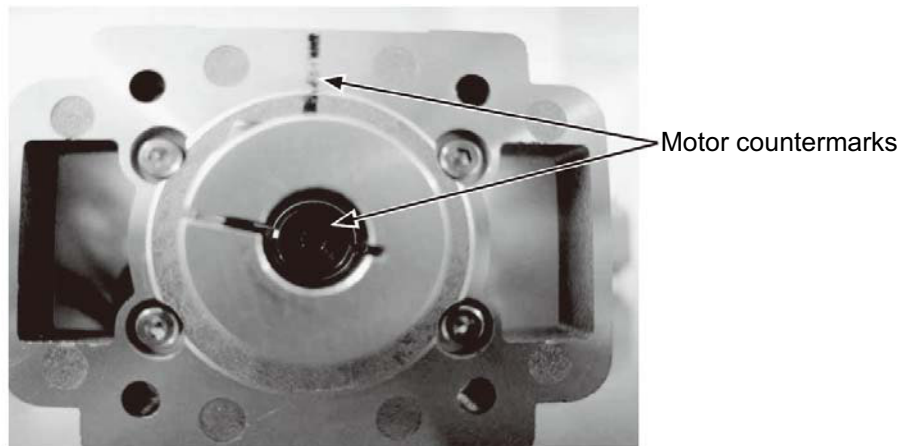

14) Pull out the end cap of the replacement motor.

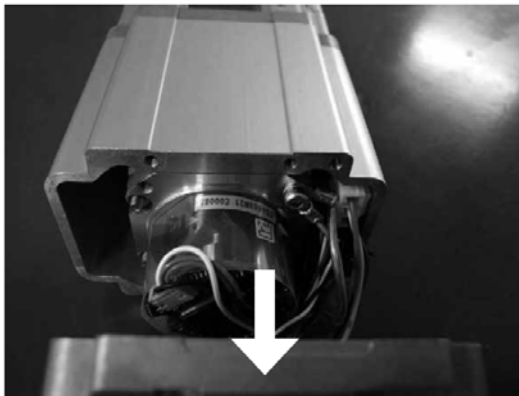

15) Once the end cap of the replacement motor has been pulled out, the motor is exposed.

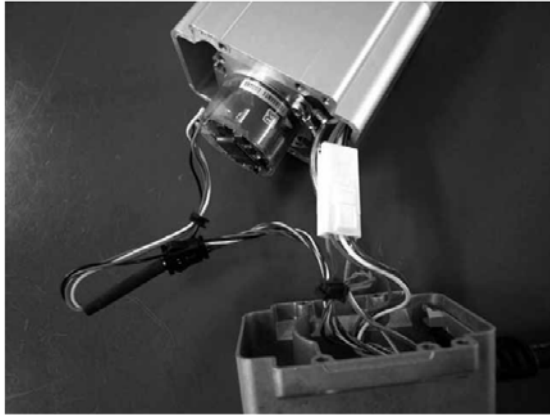

 Caution: Caution: Never touch the encoder. Doing so may cause the encoder position to shift, in which case the encoder will no longer operate properly.

16) Remove the supplied cable of the replacement motor.
Use an Allen wrench of 2.5 mm across flats to disconnect the ground wire.

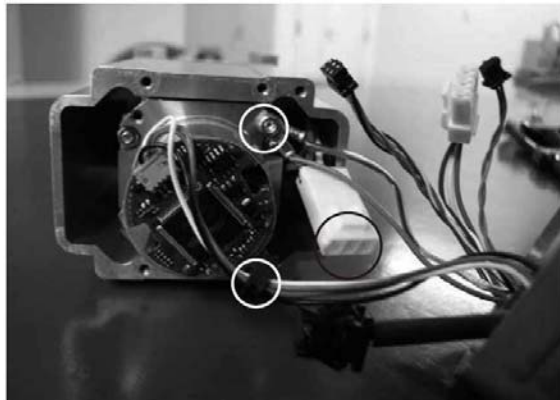

17) Install the replacement motor by aligning the cable direction.

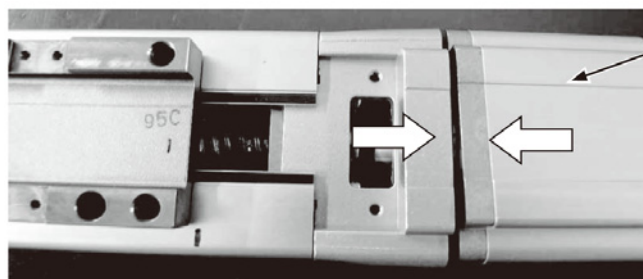

Replacement motor

- 18) Use an Allen wrench of 3.0 mm across flats to loosely tighten the motor screws. (Tighten the screws by hand until they are roughly secured.)

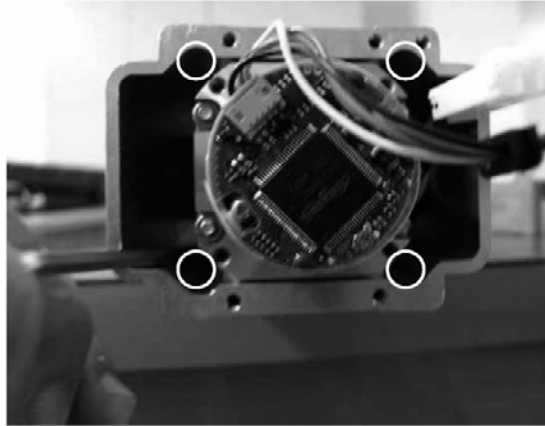

- 19) With the motor loosely secured, use an Allen wrench of 2.5 mm across flats to tighten the coupling screws on the motor end.

Tightening Torque : 150N · cm (15.3kgf · cm)

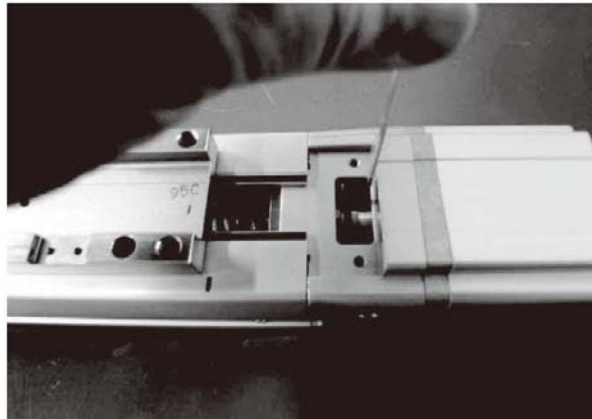

- 20) Loosen the screws you have only loosely tightened, move the slider back and forth 3 to 4 times by hand (over as long an operation stroke as possible), move the slider to near the mechanical end on the motor side, and once the slider is at a position where the motor vibration becomes the smallest, securely tighten the screws on the motor unit.

Use an Allen wrench of 3.0 mm across flats to tighten the motor screws.

Tightening Torque: 176N · cm (18.0kgf · cm)

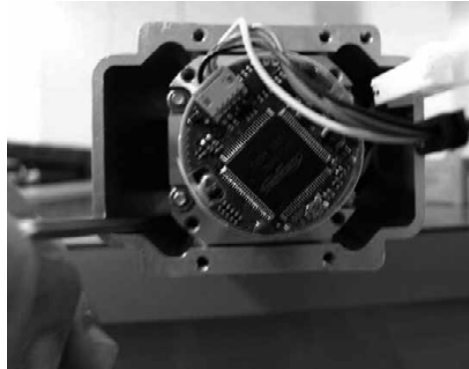

- * If the actuator has a brake, connect the encoder cable, plug in only the connector on the brake lead wire, and turn on the controller power. Next, release the brake and move the slider. To ensure safety, secure the motor unit before canceling the brake release switch, and then turn off the controller power and unplug the connector on the encoder cable.

- 21) Use an Allen wrench of 2.5 mm across flats to connect the ground wire. Plug in the connector.

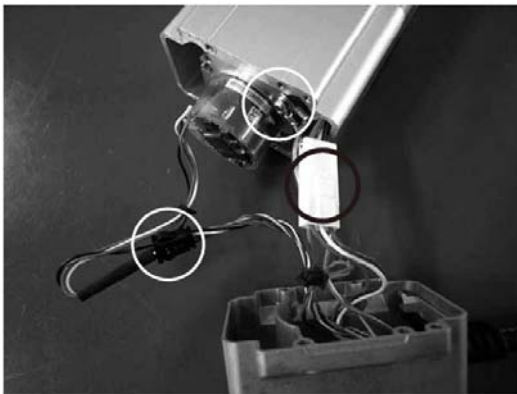

Tightening Torque : 83N · cm (8.47kgf · cm)

- 22) Install the motor rear cover of the replacement motor.

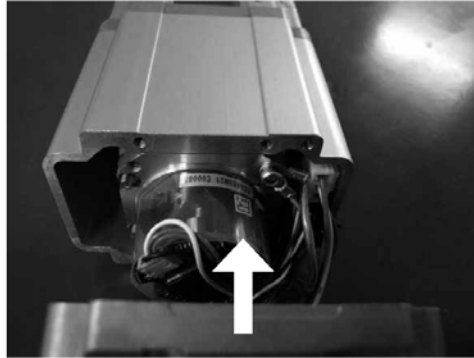

- 23) Use an Allen wrench of 2 mm across flats to tighten the motor end cap bolts.
Use a screwdriver to tighten the ground terminal bolt.

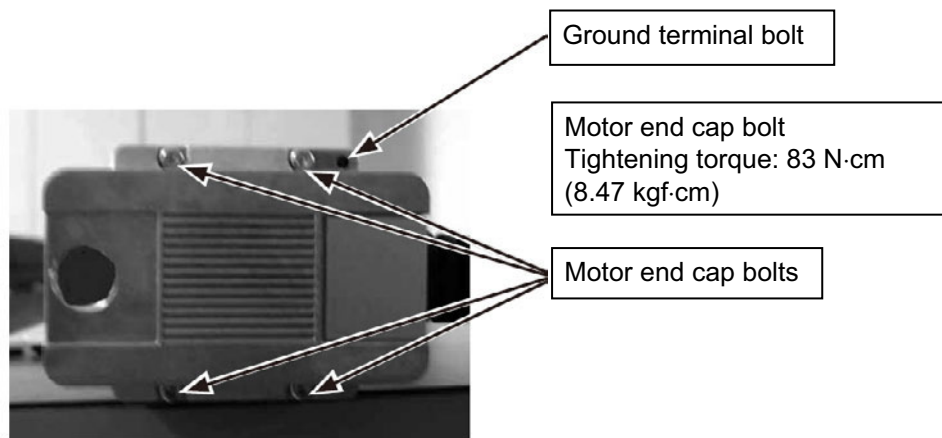

- 24) Use an Allen wrench of 2 mm across flats to tighten the screws and install the cover.

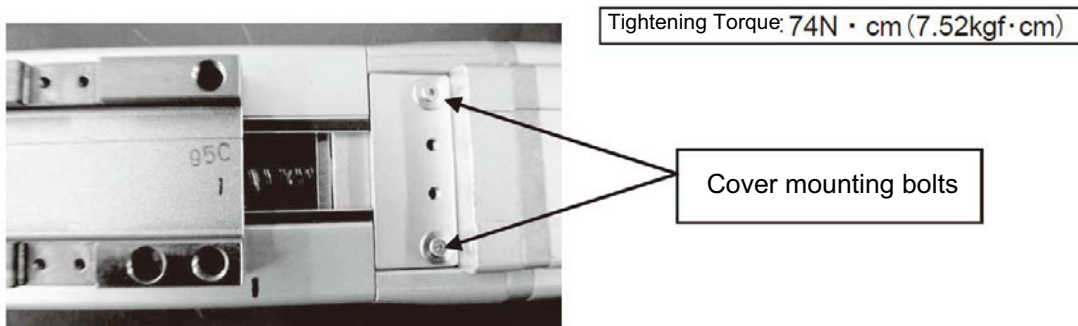

25) Use an Allen wrench of 2 mm across flats to tighten the two screws to install the stainless sheet.

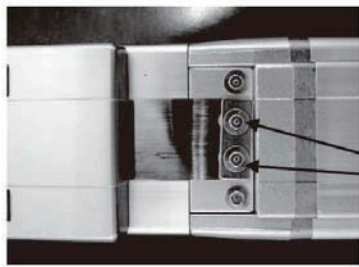

Tightening Torque: 74N · cm (7.52kgf · cm)

Stainless sheet bolts

26) Install the clearance check jig to adjust the stainless sheet.

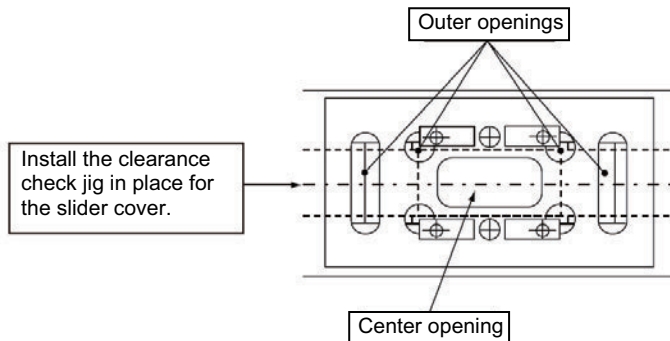

27) Adjust the tension of the stainless sheet.

[1] While looking through the center opening in the clearance-checking tool, move the stainless sheet on the loose end in the directions of arrows until the clearance between the top face of the stainless sheet and the back of the clearance-checking tool falls within the specified range.

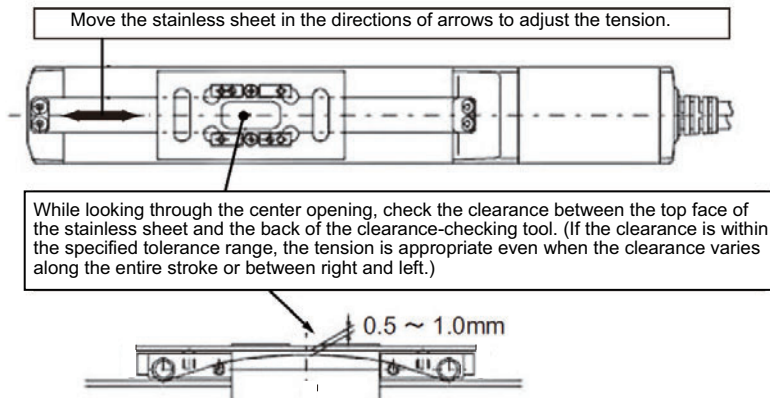

[2] When the stainless sheet has been properly positioned, tighten the screws on the loose end to a level that the stainless sheet no longer moves.

[3] Move the slider and check the tension of the stainless sheet along the entire stroke.

Checkpoint 1:

Check if the clearance between the top face of the stainless sheet and the back of the clearance-checking tool falls within the specified range along the entire stroke.

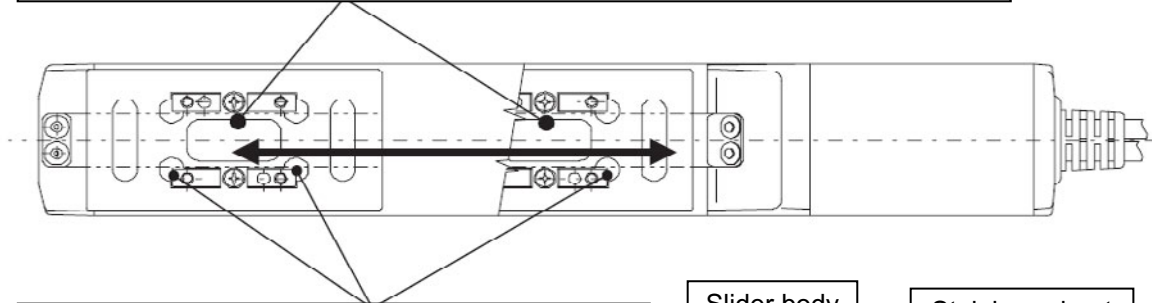

Checkpoint 2:

Look through the peripheral openings and confirm that the stainless sheet edges do not contact the slider body. Move the slider back and forth at least three times over the entire stroke to ensure the edges do not contact the slider. The sheet may move during the slider strokes, but slight movement is acceptable as long as the offset does not increase and the sheet does not contact the slider. If the stainless sheet contacts the slider, repeat the adjustment from [1].

The stainless sheet is not perfectly straight, but it bends to right and left slightly. It is impossible to adjust the right and left clearances perfectly uniform. Slight variation in clearance in the stroke direction or between right and left is acceptable, as long as the stainless sheet edges do not contact the slider body over the entire stroke.

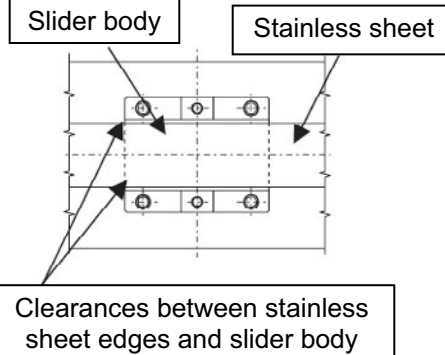

If the conditions in Checkpoints 1 and 2 are not satisfied, loosen the screws and readjust the position and tension of the stainless sheet again from [1].

Note) If the condition in Checkpoint 2 cannot be met after the readjustment, try installing the stainless sheet in the reverse direction or placing it upside down. If the stainless sheet is still not adjusted properly, replace it with a new sheet.

[4] When proper clearances are obtained between the slider body and stainless sheet and an absence of contact between the two is confirmed, tighten the two screws on the loose end alternately, and then finally tighten all screws to a uniform torque to securely affix the stainless sheet. If the screws are not tightened uniformly, the sheet may meander or lift.

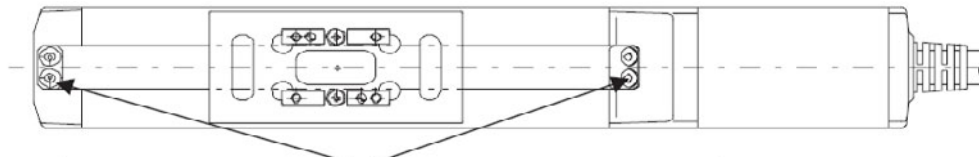

Apply additional torque to the screws on both ends until the stainless sheet no longer moves.
Tightening torque: 87.2 N-cm (8.90 kgf-cm) [Reference value]

[5] Remove the clearance-checking tool and install the slider covers.

Note) Again, pay attention not to lose the coil springs and spacers.

11.10.11 Replacing the Motor of the Motor Straight Type (Built-in Type)

The motors of built-in type actuators cannot be replaced by the customer. If you need to replace the motor of any such actuator, please consult IAI.

12. Appendix

12.1 External Dimensions

12.1.1 RCS2-SA4C

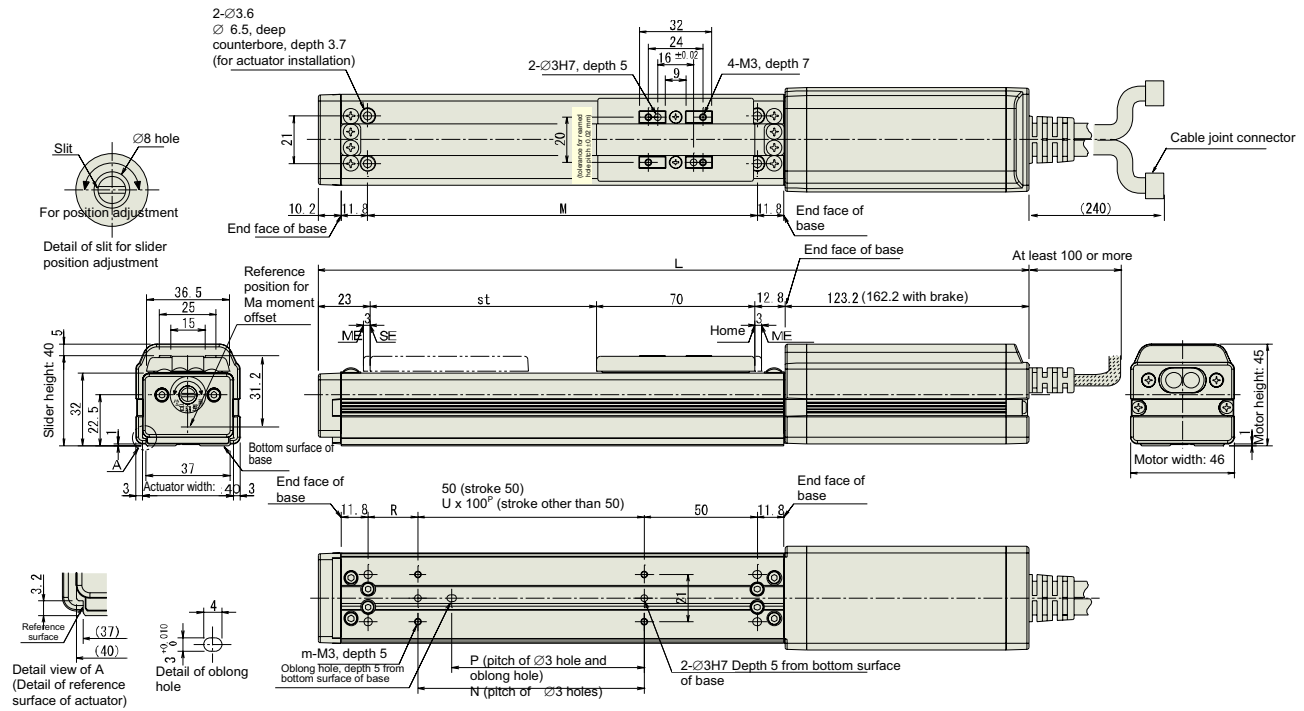

	Stroke	50	100	150	200	250	300	350	400
L	without brake	279	329	379	429	479	529	579	629
	with brake	318	368	418	468	518	568	618	668
	M	122	172	222	272	322	372	422	472
	N	50	100	100	200	200	300	300	400
	P	35	85	85	185	185	285	285	385
	R	22	22	72	22	72	22	72	22
	U	-	1	1	2	2	3	3	4
	m	4	4	4	6	6	8	8	10
Weight [kg]	without brake	0.7	0.8	0.9	1.0	1.1	1.2	1.3	1.4
	with brake	1.0	1.1	1.2	1.3	1.4	1.5	1.6	1.7

12.1.2 RCS2-SA5C

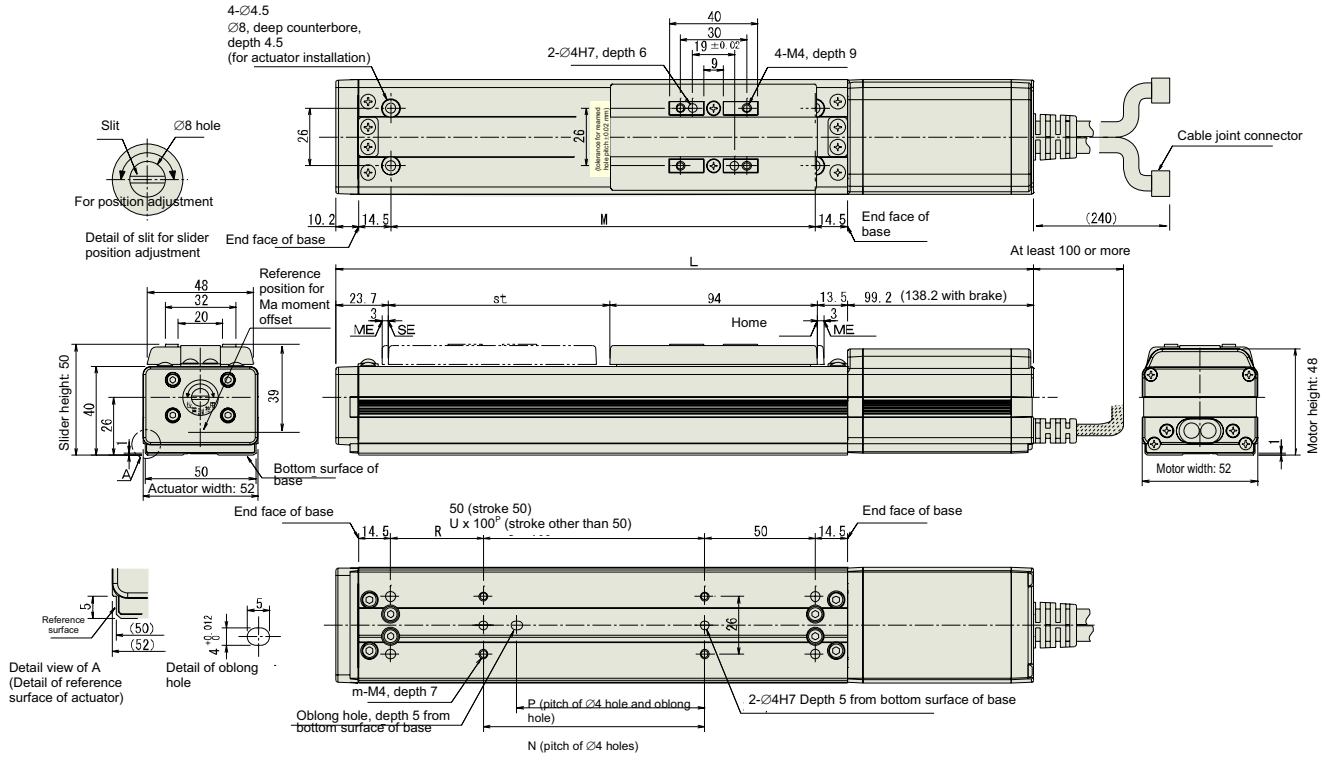

	Stroke	50	100	150	200	250	300	350	400	450	500
L	without brake	280.4	330.4	380.4	430.4	480.4	530.4	580.4	630.4	680.4	730.4
	with brake	319.4	369.4	419.4	469.4	519.4	569.4	619.4	669.4	719.4	769.4
M		142	192	242	292	342	392	442	492	542	592
N		50	100	100	200	200	300	300	400	400	500
P		35	85	85	185	185	285	285	385	385	485
R		42	42	92	42	92	42	92	42	92	42
U		-	1	1	2	2	3	3	4	4	5
m		4	4	4	6	6	8	8	10	10	12
Weight [kg]	without brake	1.3	1.4	1.5	1.6	1.7	1.8	1.9	2.0	2.1	2.2
	with brake	1.6	1.7	1.8	1.9	2.0	2.1	2.2	2.3	2.4	2.5

12.1.3 RCS2-SA6C

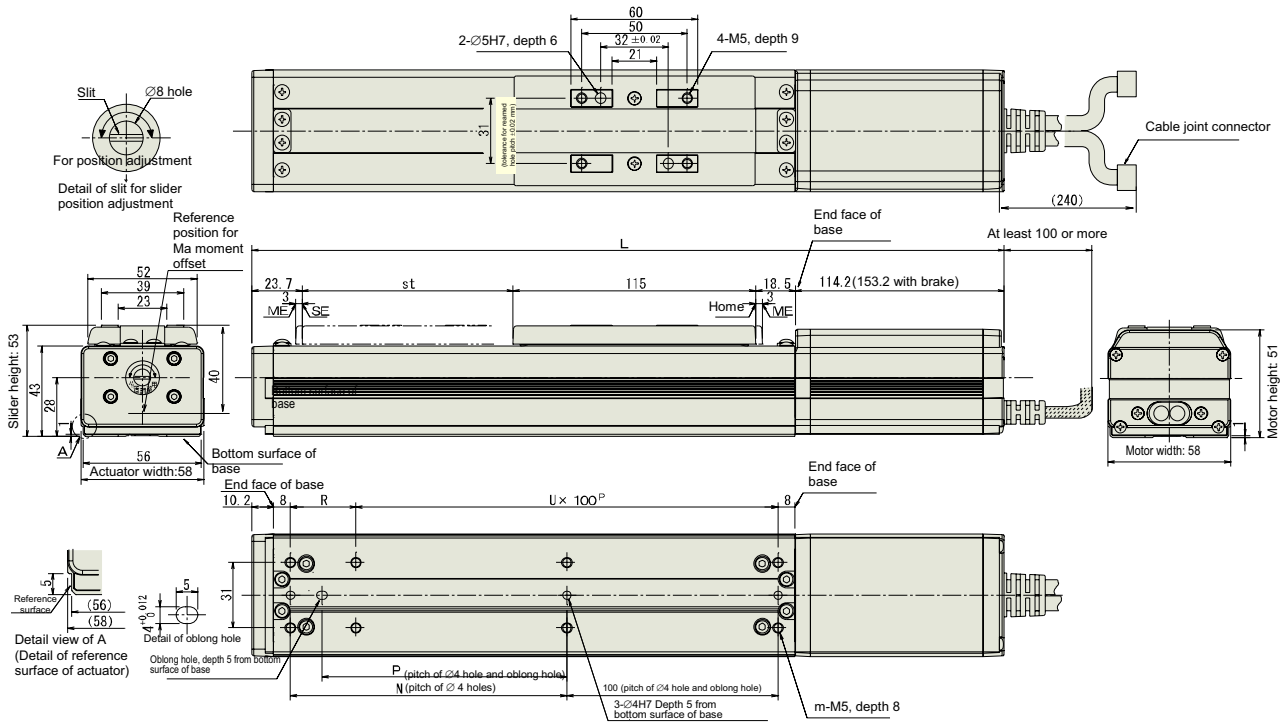

Stroke		50	100	150	200	250	300	350	400	450	500	550	600
L	without brake	321.4	371.4	421.4	471.4	521.4	571.4	621.4	671.4	721.4	771.4	821.4	871.4
	with brake	360.4	410.4	460.4	510.4	560.4	610.4	660.4	710.4	760.4	810.4	860.4	910.4
N		81	131	181	231	281	331	381	431	481	531	581	631
P		66	116	166	216	266	316	366	416	466	516	566	616
R		81	31	81	31	81	31	81	31	81	31	81	31
U		1	2	2	3	3	4	4	5	5	6	6	7
m		6	8	8	10	10	12	12	14	14	16	16	18
Weight [kg]	without brake	1.4	1.6	1.8	2.0	2.2	2.4	2.6	2.8	3.0	3.2	3.4	3.6
	with brake	1.7	1.9	2.1	2.3	2.5	2.7	2.9	3.1	3.3	3.5	3.7	3.9

12.1.4 RCS2-SA7C

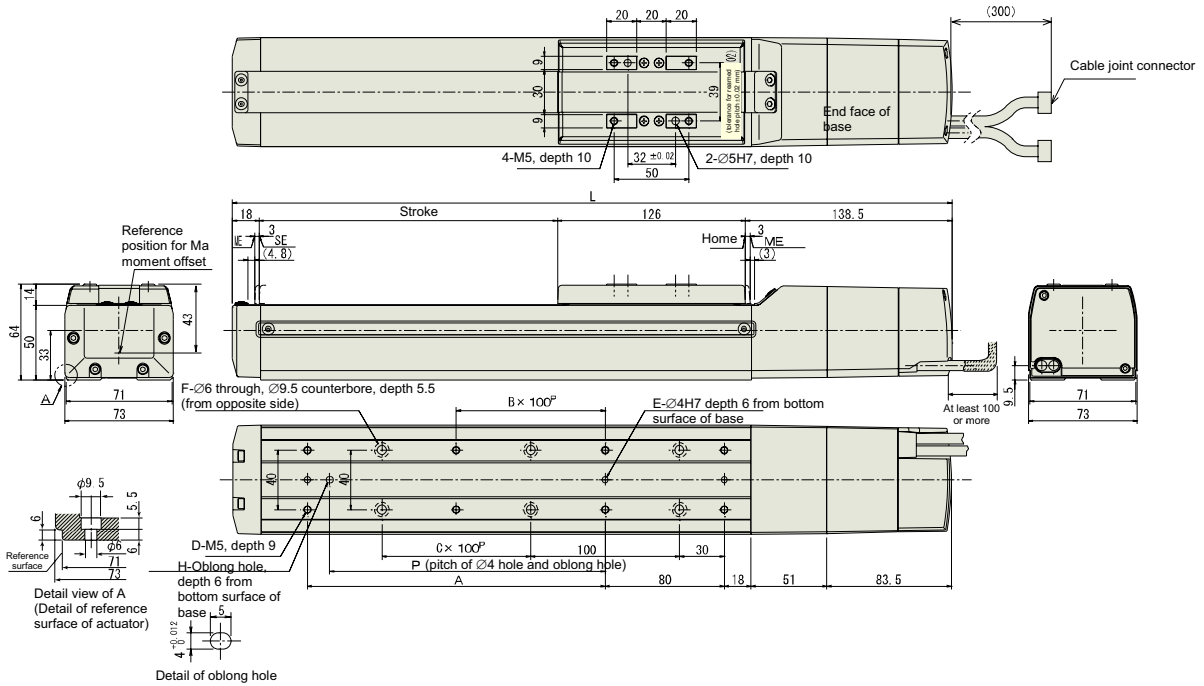

Brake Dimensions

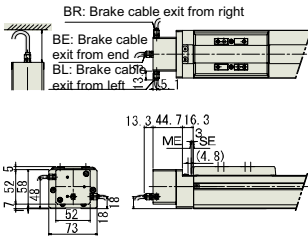

Stroke	50	100	150	200	250	300	350	400	450	500	550	600	650	700	750	800
L	332.5	382.5	432.5	482.5	532.5	582.5	632.5	682.5	732.5	782.5	832.5	882.5	932.5	982.5	1032.5	1082.5
A	0	100	100	200	200	300	300	400	400	500	500	600	600	700	700	800
B	0	0	0	1	1	2	2	3	3	4	4	5	5	6	6	7
C	0	0	1	1	2	2	3	3	4	4	5	5	6	6	7	7
D	4	6	6	8	8	10	10	12	12	14	14	16	16	18	18	20
E	2	3	3	3	3	3	3	3	3	3	3	3	3	3	3	3
F	4	4	6	6	8	8	10	10	12	12	14	14	16	16	18	18
H	0	1	1	1	1	1	1	1	1	1	1	1	1	1	1	1
P	0	85	85	185	185	285	285	385	385	485	485	585	585	685	685	785
Weight [kg]	without brake	2.4	2.6	2.8	3.0	3.3	3.5	3.7	3.9	4.2	4.4	4.6	4.8	5.1	5.3	5.5
	with brake	3.0	3.2	3.4	3.6	3.9	4.1	4.3	4.5	4.8	5.0	5.2	5.4	5.7	5.9	6.1

12.1.5 RCS2-SS7C

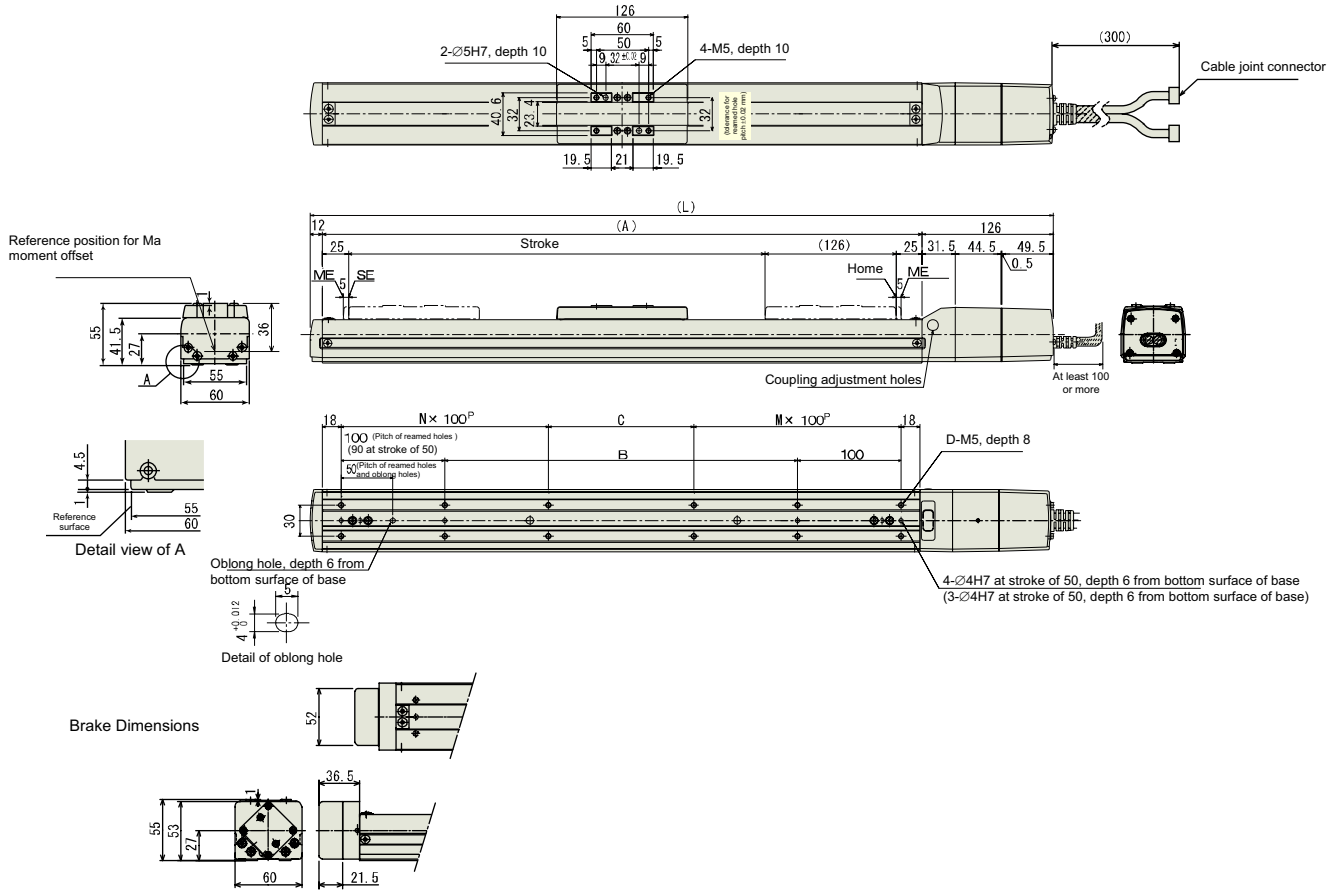

Stroke	50	100	150	200	250	300	350	400	450	500	550	600	
L	364	414	464	514	564	614	664	714	764	814	864	914	
A	226	276	326	376	426	476	526	576	626	676	726	776	
B	0	40	90	140	190	240	290	340	390	440	490	540	
C	90	40	90	140	190	40	90	140	190	40	90	140	
D	6	8	8	8	8	12	12	12	12	16	16	16	
M	1	1	1	1	1	2	2	2	2	3	3	3	
N	0	1	1	1	1	2	2	2	2	3	3	3	
Weight [kg]	without brake	2.9	3.2	3.5	3.8	4.2	4.5	4.8	5.1	5.5	5.8	6.1	6.4
	with brake	3.2	3.5	3.8	4.1	4.5	4.8	5.1	5.4	5.8	6.1	6.4	6.7

12.1.6 RCS2-SS8C

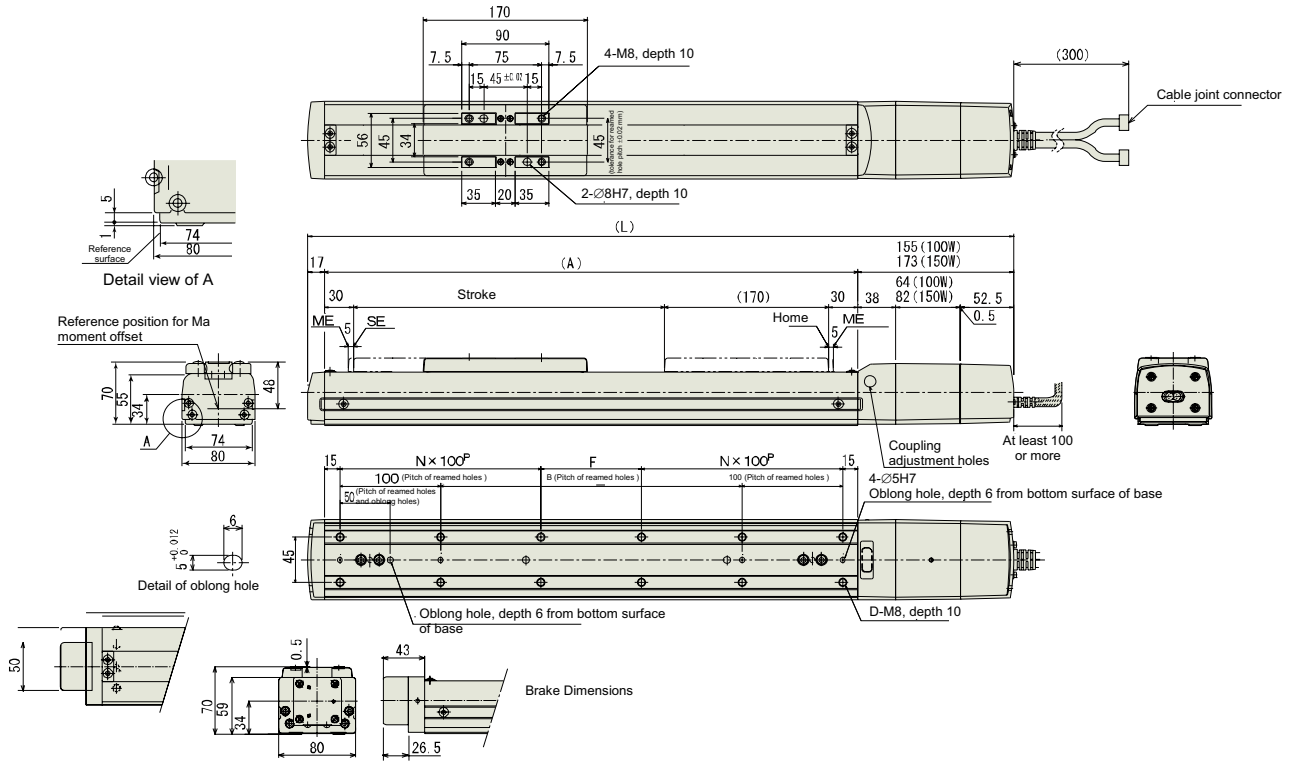

Stroke	50	100	150	200	250	300	350	400	450	500	550	600	650	700	
L (100W)	452	502	552	602	652	702	752	802	852	902	952	1002	1052	1102	
L (150W)	470	520	570	620	670	720	770	820	870	920	970	1020	1070	1120	
A	280	330	380	430	480	530	580	630	680	730	780	830	880	930	
B	50	100	150	200	250	300	350	400	450	500	550	600	650	700	
D	8	8	8	10	12	12	12	14	16	16	16	18	20	20	
F	50	100	150	0	50	100	150	0	50	100	150	0	50	100	
N	1	1	1	2	2	2	2	3	3	3	3	4	4	4	
Weight [kg]	without brake	6.0	6.5	7.1	7.6	8.2	8.7	9.3	9.8	10.4	10.9	11.5	12.0	12.6	13.1
	with brake	6.5	7.0	7.6	8.1	8.7	9.2	9.8	10.3	10.9	11.4	12.0	12.5	13.1	13.6

Stroke	750	800	850	900	950	1000	
L (100W)	1152	1202	1252	1302	1352	1402	
L (150W)	1170	1220	1270	1320	1370	1420	
A	980	1030	1080	1130	1180	1230	
B	750	800	850	900	950	1000	
D	20	22	24	24	24	26	
F	150	0	50	100	150	0	
N	4	5	5	5	5	6	
Weight [kg]	without brake	13.7	14.2	14.8	15.3	15.9	16.4
	with brake	14.2	14.7	15.3	15.8	16.4	16.9

12.1.7 RCS2-SA4D

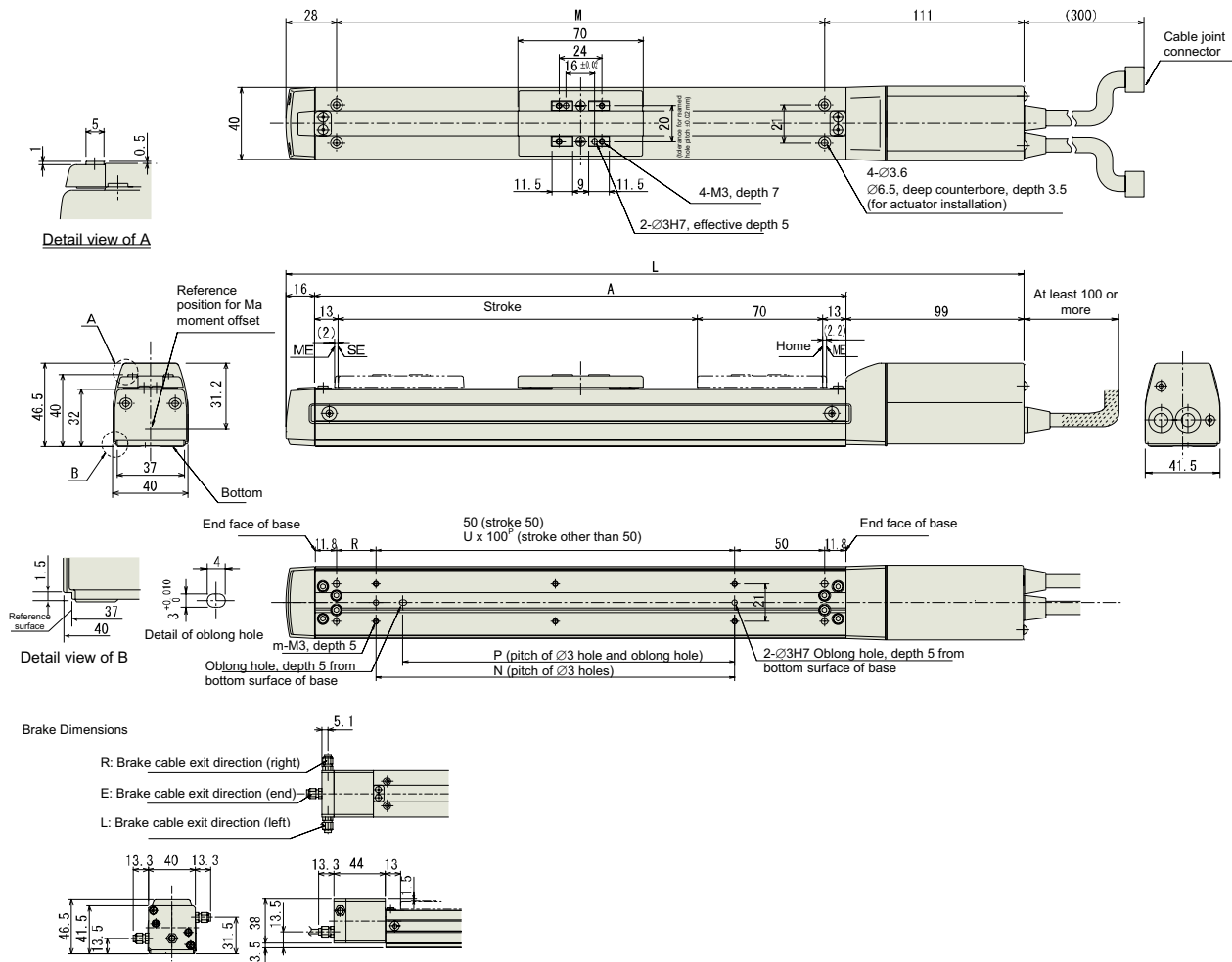

Stroke	50	100	150	200	250	300	
L	261	311	361	411	461	511	
A	146	196	246	296	346	396	
M	122	172	222	272	322	372	
N	50	100	100	200	200	300	
P	35	85	85	185	185	285	
R	22	22	72	22	72	22	
U	-	1	1	2	2	3	
m	4	4	4	6	6	8	
Weight [kg]	without brake	0.8	0.9	1.0	1.1	1.2	1.3
	with brake	1.0	1.1	1.2	1.3	1.4	1.5

12.1.8 RCS2-SA5D

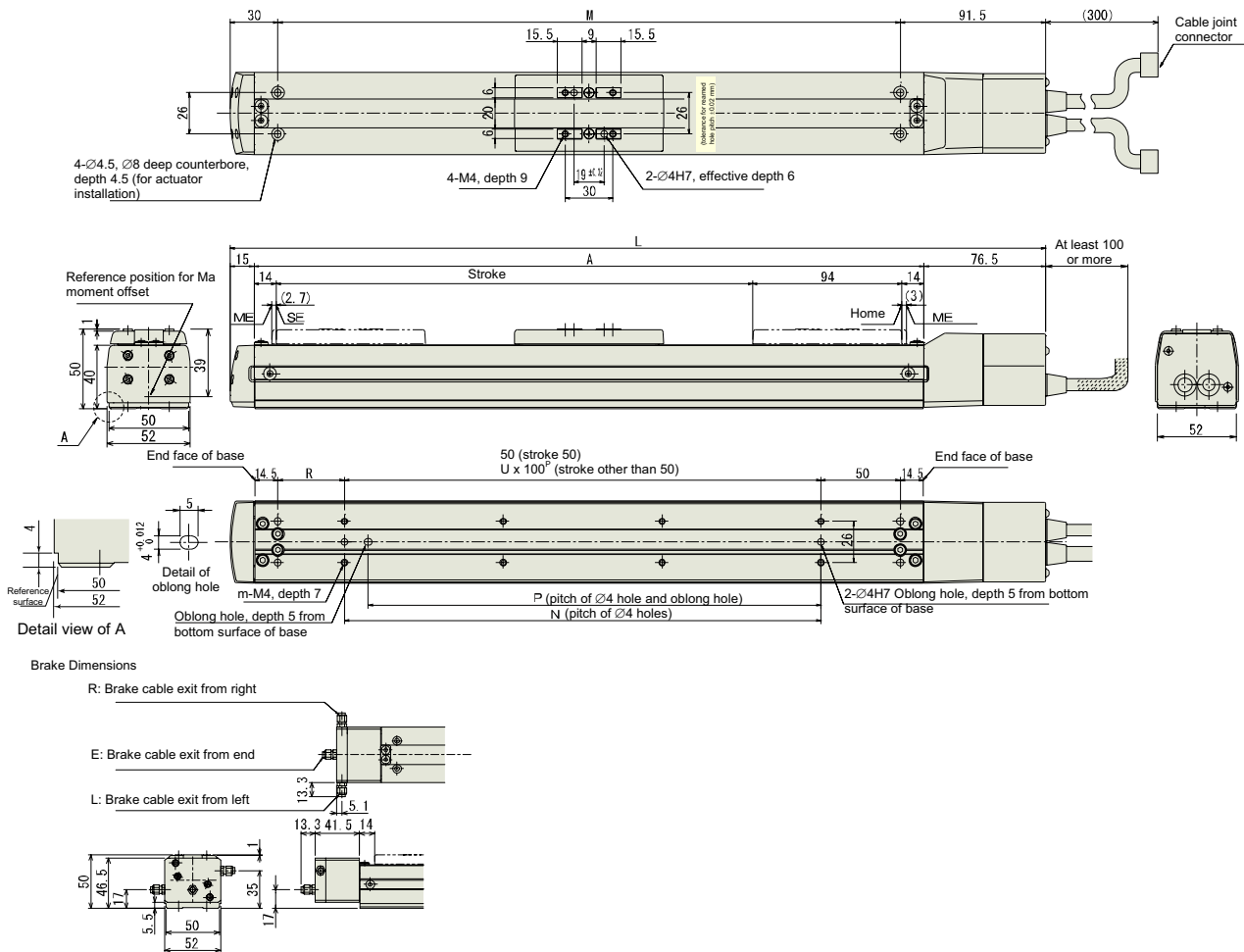

Stroke	50	100	150	200	250	300	350	400	450	500	
L	263.5	313.5	363.5	413.5	463.5	513.5	563.5	613.5	663.5	713.5	
A	172	222	272	322	372	422	472	522	572	622	
M	142	192	242	292	342	392	442	492	542	592	
N	50	100	100	200	200	300	300	400	400	500	
P	30	85	85	185	185	285	285	385	385	485	
R	42	42	92	42	92	42	92	42	92	42	
U	-	1	1	2	2	3	3	4	4	5	
m	4	4	4	6	6	8	8	10	10	12	
Weight [kg]	without brake	1.4	1.5	1.6	1.7	1.8	1.9	2.0	2.1	2.2	2.3
	with brake	1.7	1.8	1.9	2.0	2.1	2.2	2.3	2.4	2.5	2.6

12.1.9 RCS2-SA6D

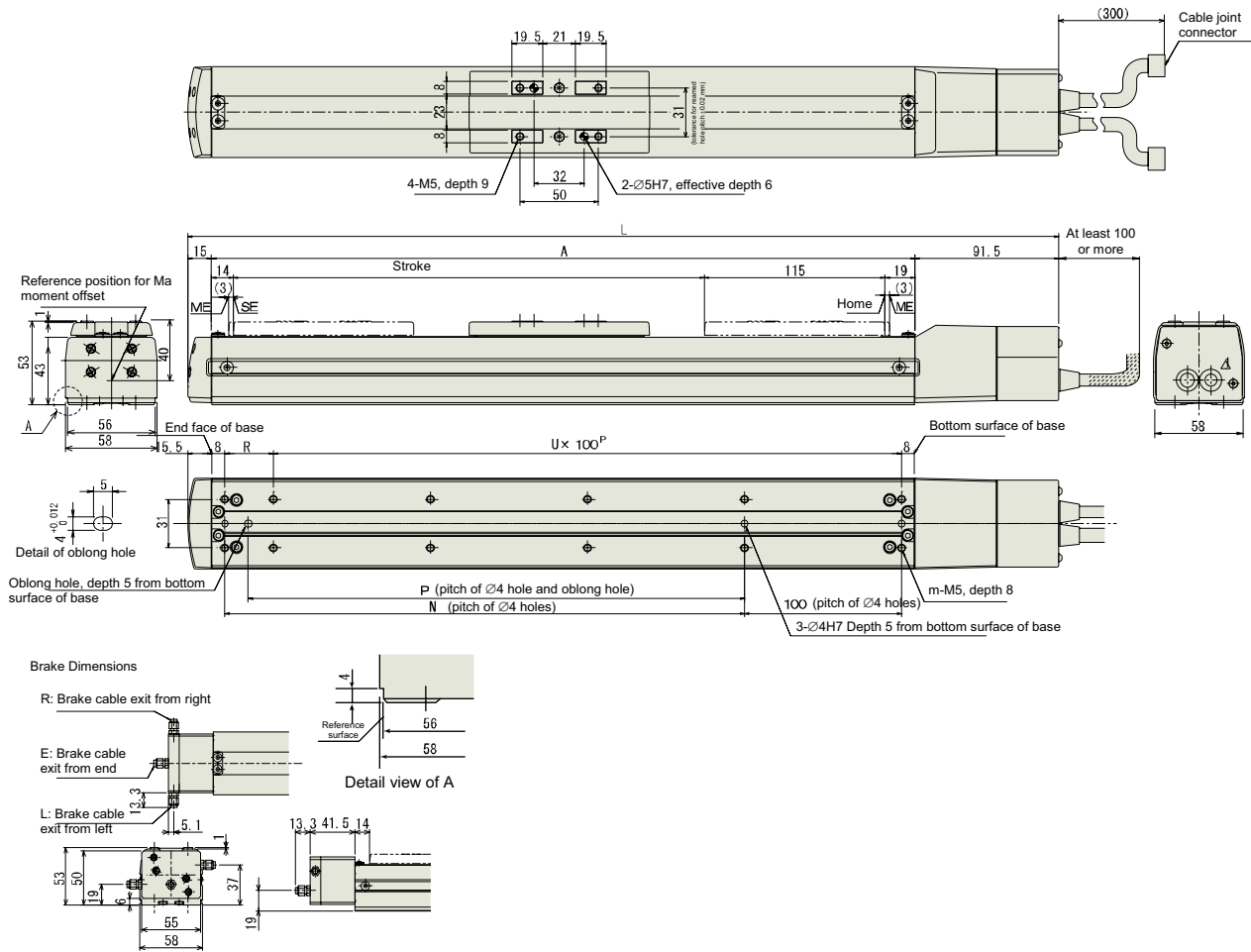

Stroke	50	100	150	200	250	300	350	400	450	500	550	600
L	304.5	354.5	404.5	454.5	504.5	554.5	604.5	654.5	704.5	754.5	804.5	854.5
A	198	248	298	348	398	448	498	548	598	648	698	748
N	81	131	181	231	281	331	381	431	481	531	581	631
P	66	116	166	216	266	316	366	416	466	516	566	616
R	81	31	81	31	81	31	81	31	81	31	81	31
U	1	2	2	3	3	4	4	5	5	6	6	7
m	6	8	8	10	10	12	12	14	14	16	16	18
Weight [kg]	without brake	1.3	1.5	1.7	1.9	2.1	2.3	2.5	2.7	2.9	3.1	3.5
	with brake	1.6	1.8	2.0	2.2	2.4	2.6	2.8	3.0	3.2	3.4	3.8

12.1.12 RCS2-SA6R

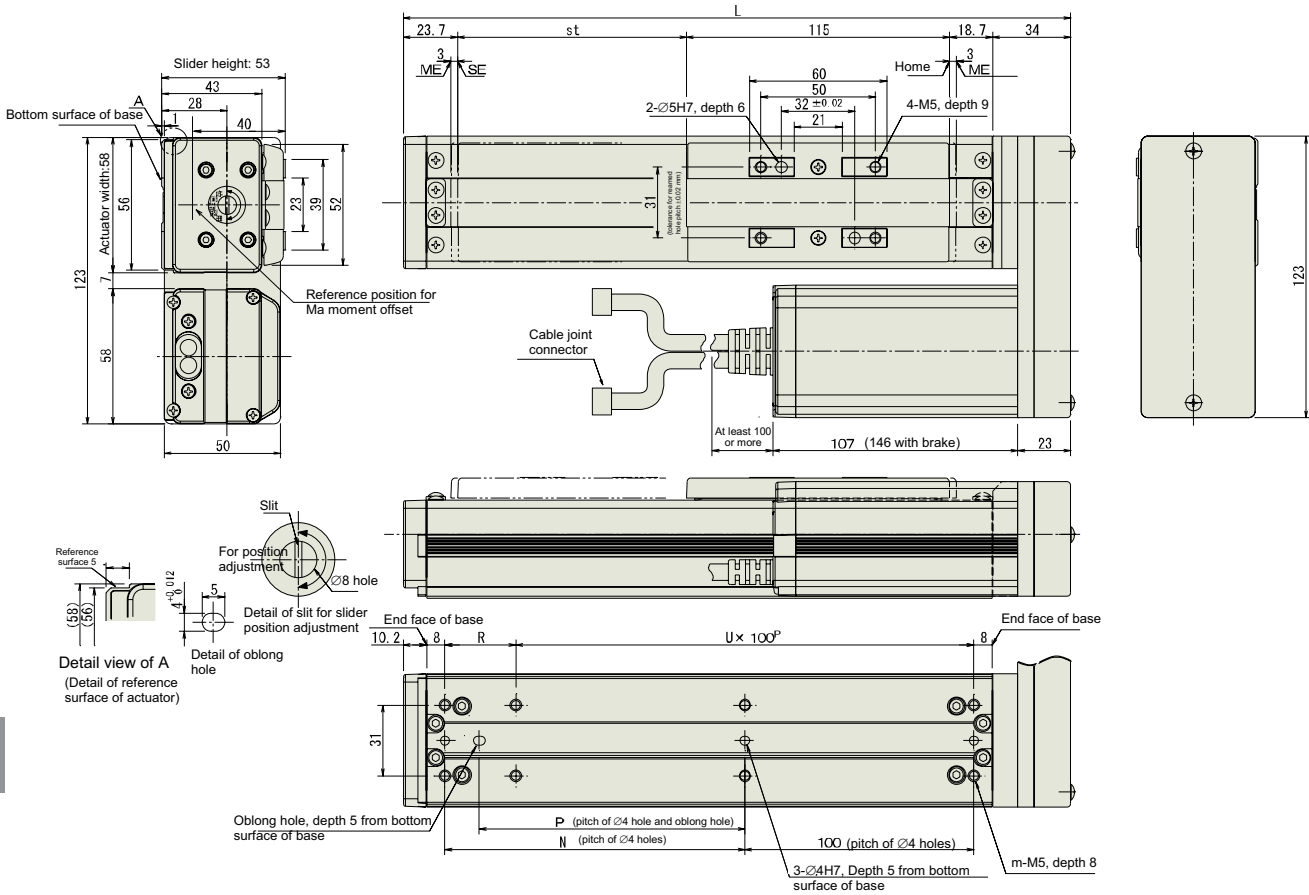

Stroke	50	100	150	200	250	300	350	400	450	500	550	600
L	241.4	291.4	341.4	391.4	441.4	491.4	541.4	591.4	641.4	691.4	741.4	791.4
N	81	131	181	231	281	331	381	431	481	531	581	631
P	66	116	166	216	266	316	366	416	466	516	566	616
R	81	31	81	31	81	31	81	31	81	31	81	31
U	1	2	2	3	3	4	4	5	5	6	6	7
m	6	8	8	10	10	12	12	14	14	16	16	18
Weight [kg]	without brake	1.7	1.9	2.1	2.3	2.5	2.7	2.9	3.1	3.3	3.5	3.9
	with brake	2.0	2.2	2.4	2.6	2.8	3.0	3.2	3.4	3.6	3.8	4.2

12.1.14 RCS2-SS7R

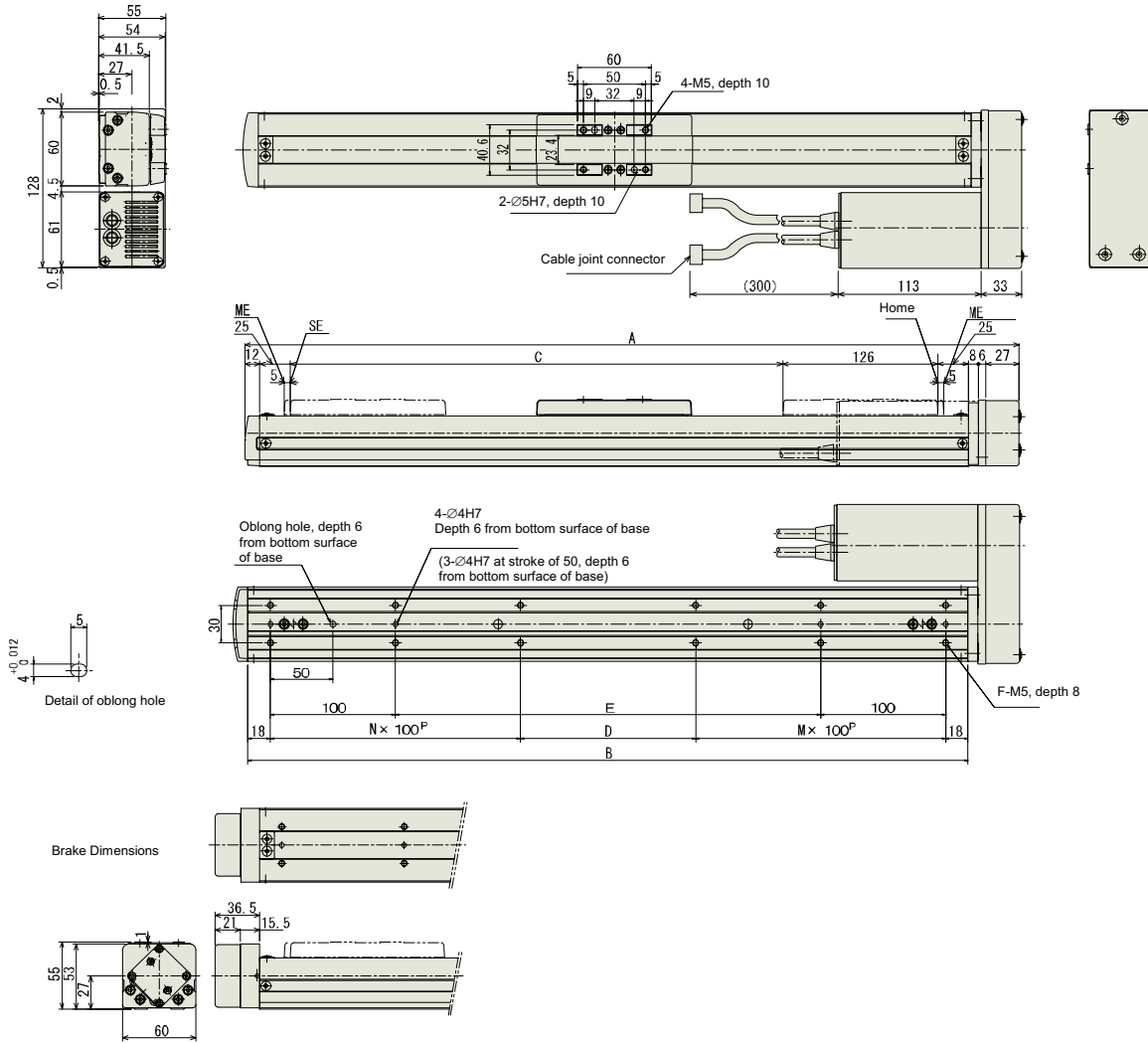

Stroke	50	100	150	200	250	300	350	400	450	500	550	600	
A	279	329	379	429	479	529	579	629	679	729	779	829	
B	226	276	326	376	426	476	526	576	626	676	726	776	
C	50	100	150	200	250	300	350	400	450	500	550	600	
D	90	40	90	140	190	40	90	140	190	40	90	140	
E	0	40	90	140	190	240	290	340	390	440	490	540	
F	6	8	8	8	8	12	12	12	12	16	16	16	
M	1	1	1	1	1	2	2	2	2	3	3	3	
N	0	1	1	1	1	2	2	2	2	3	3	3	
Weight [kg]	without brake	3.7	4.0	4.3	4.6	4.9	5.2	5.5	5.8	6.1	6.4	6.7	7.0
	with brake	4.0	4.3	4.6	4.9	5.2	5.5	5.8	6.1	6.4	6.7	7.0	7.3

12.1.15 RCS2-SS8R

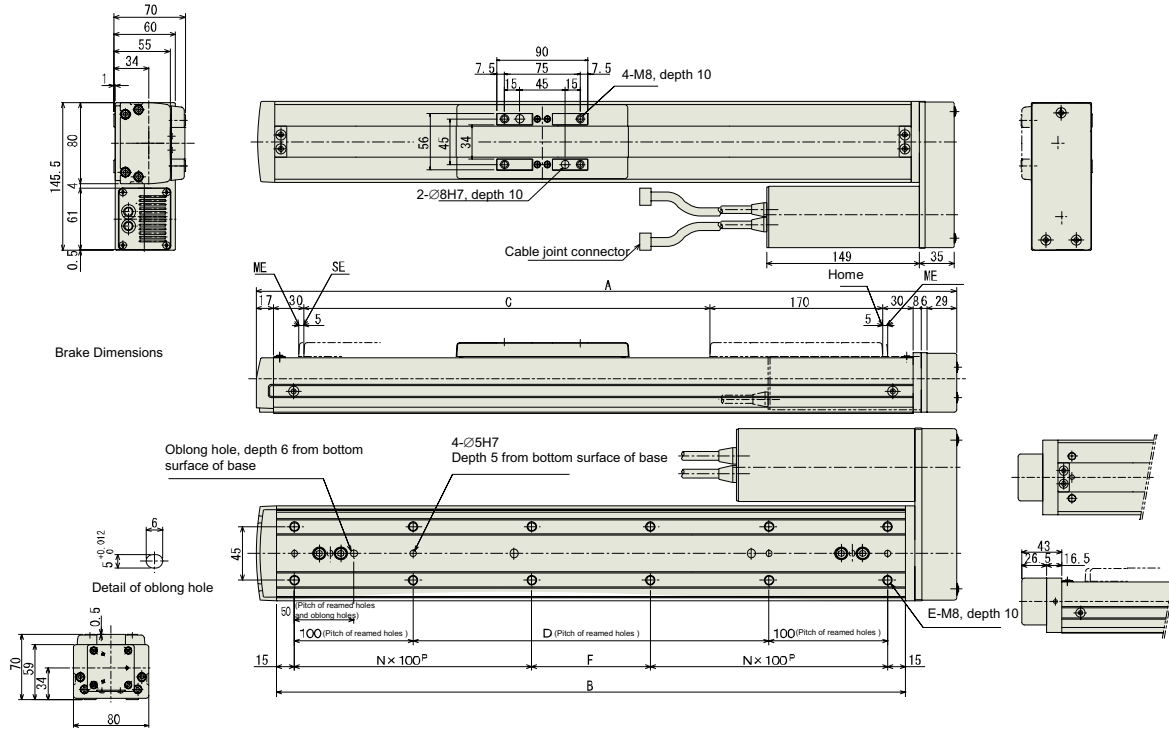

Stroke	50	100	150	200	250	300	350	400	450	500	550	600	650	700	
A	340	390	440	490	540	590	640	690	740	790	840	890	940	990	
B	280	330	380	430	480	530	580	630	680	730	780	830	880	930	
C	50	100	150	200	250	300	350	400	450	500	550	600	650	700	
D	50	100	150	200	250	300	350	400	450	500	550	600	650	700	
E	8	8	8	10	12	12	12	14	16	16	16	18	20	20	
F	50	100	150	0	50	100	150	0	50	100	150	0	50	100	
N	1	1	1	2	2	2	2	3	3	3	3	4	4	4	
Weight [kg]	without brake	6.7	7.2	7.7	8.2	8.7	9.2	9.7	10.2	10.7	11.2	11.7	12.2	12.7	13.2
	with brake	7.2	7.7	8.2	8.7	9.2	9.7	10.2	10.7	11.2	11.7	12.2	12.7	13.2	13.7

Stroke	750	800	850	900	950	1000	
A	1040	1090	1140	1190	1240	1290	
B	980	1030	1080	1130	1180	1230	
C	750	800	850	900	950	1000	
D	750	800	850	900	950	1000	
E	20	22	24	24	24	26	
F	150	0	50	100	150	0	
N	4	5	5	5	5	6	
Weight [kg]	without brake	13.7	14.2	14.7	15.2	15.7	16.2
	with brake	14.2	14.7	15.2	15.7	16.2	16.7

12.1.18 RCS2CR-SA6C

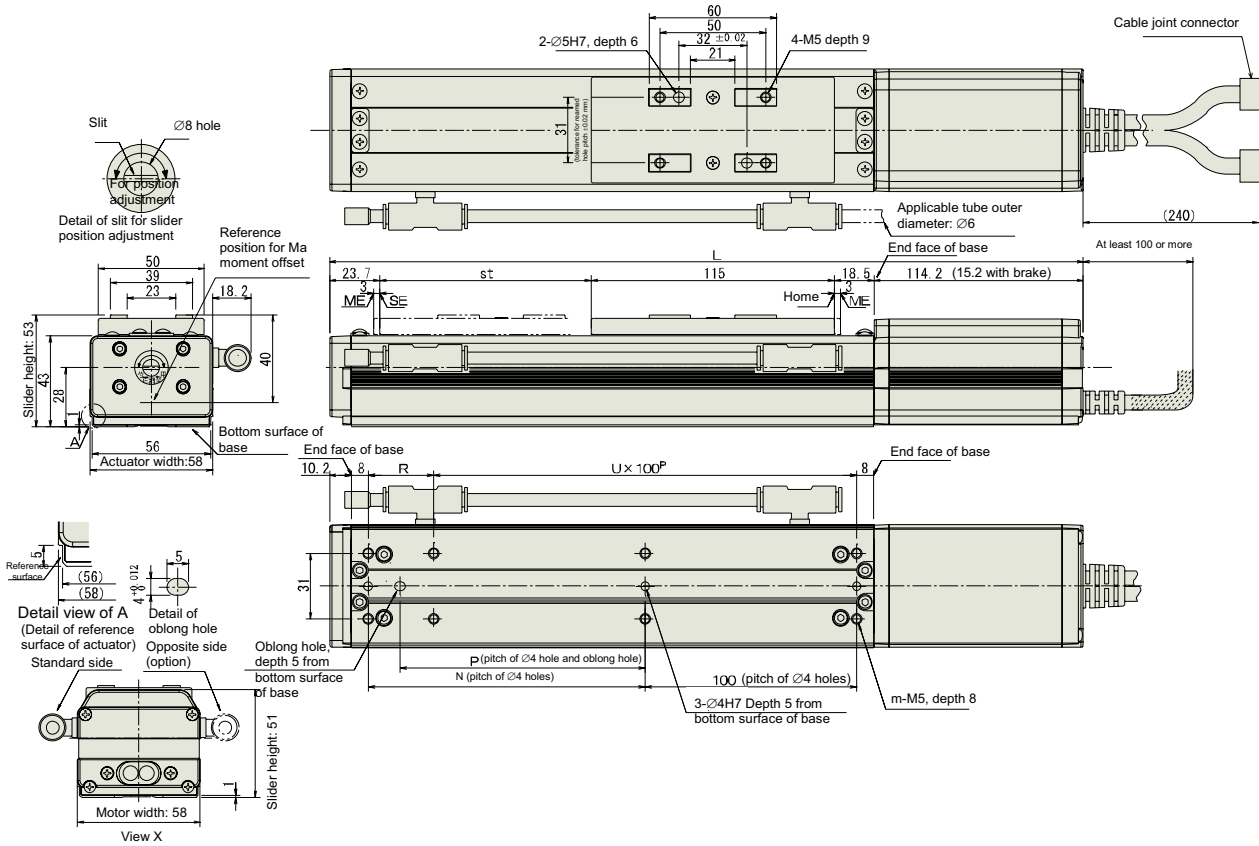

Stroke		50	100	150	200	250	300	350	400	450	500	550	600
L	without brake	321.4	371.4	421.4	471.4	521.4	571.4	621.4	671.4	721.4	771.4	821.4	871.4
	with brake	360.4	410.4	460.4	510.4	560.4	610.4	660.4	710.4	760.4	810.4	860.4	910.4
N		81	131	181	231	281	331	381	431	481	531	581	631
P		66	116	166	216	266	316	366	416	466	516	566	616
R		81	31	81	31	81	31	81	31	81	31	81	31
U		1	2	2	3	3	4	4	5	5	6	6	7
m		6	8	8	10	10	12	12	14	14	16	16	18
Weight [kg]	without brake	1.4	1.6	1.8	2.0	2.2	2.4	2.6	2.8	3.0	3.2	3.4	3.6
	with brake	1.7	1.9	2.1	2.3	2.5	2.7	2.9	3.1	3.3	3.5	3.7	3.9

12.1.19 RCS2CR-SA7C

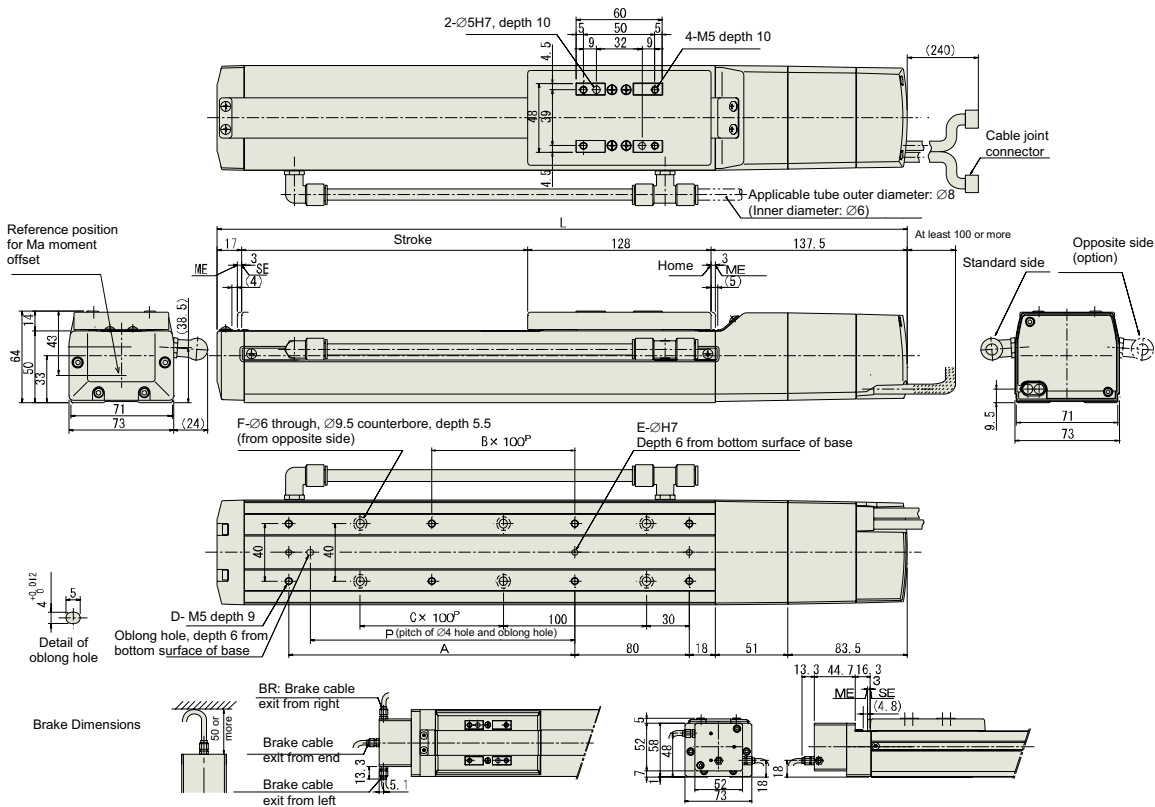

Stroke	50	100	150	200	250	300	350	400	450	500	550	600	650	700	
L	332.5	382.5	432.5	482.5	532.5	582.5	632.5	682.5	732.5	782.5	832.5	882.5	932.5	982.5	
A	0	100	100	200	200	300	300	400	400	500	500	600	600	700	
B	0	0	0	1	1	2	2	3	3	4	4	5	5	6	
C	0	0	1	1	2	2	3	3	4	4	5	5	6	6	
D	4	6	6	8	8	10	10	12	12	14	14	16	16	18	
E	2	3	3	3	3	3	3	3	3	3	3	3	3	3	
F	4	4	6	6	8	8	10	10	12	12	14	14	16	16	
H	0	1	1	1	1	1	1	1	1	1	1	1	1	1	
P	0	85	85	185	185	285	285	385	385	485	485	585	585	685	
Weight [kg]	without brake	2.6	2.8	3.0	3.2	3.5	3.7	3.9	4.1	4.4	4.6	4.8	5.0	5.3	5.5
	with brake	3.2	3.4	3.6	3.8	4.1	4.3	4.5	4.7	5.0	5.2	5.4	5.6	5.9	6.1

Stroke	750	800	
L	1032.5	1082.5	
A	700	800	
B	6	7	
C	7	7	
D	18	20	
E	3	3	
F	18	18	
H	1	1	
P	685	785	
Weight [kg]	without brake	5.7	5.9
	with brake	6.3	6.5

12.1.20 RCS2CR-SS7C

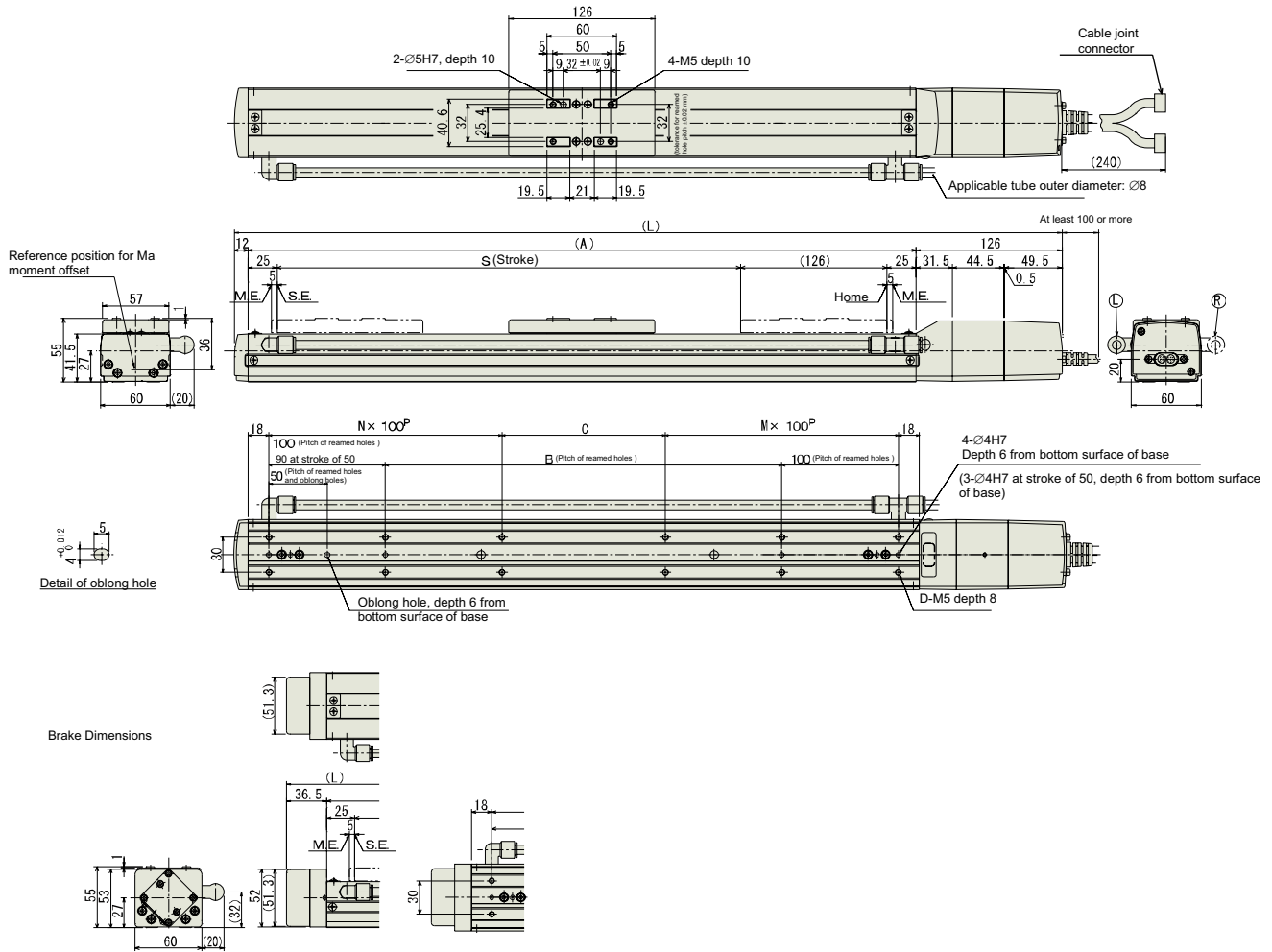

Stroke	50	100	150	200	250	300	350	400	450	500	550	600
L	364	414	464	514	564	614	664	714	764	814	864	914
A	226	276	326	376	426	476	526	576	626	676	726	776
B	0	40	90	140	190	240	290	340	390	440	490	540
C	90	40	90	140	190	40	90	140	190	40	90	140
D	6	8	8	8	8	12	12	12	12	16	16	16
M	1	1	1	1	1	2	2	2	2	3	3	3
N	0	1	1	1	1	2	2	2	2	3	3	3
Weight [kg]	3.1	3.4	3.7	4.0	4.4	4.7	5.0	5.3	5.7	6.0	6.3	6.6

12.1.22 RCS2CR-SA5D

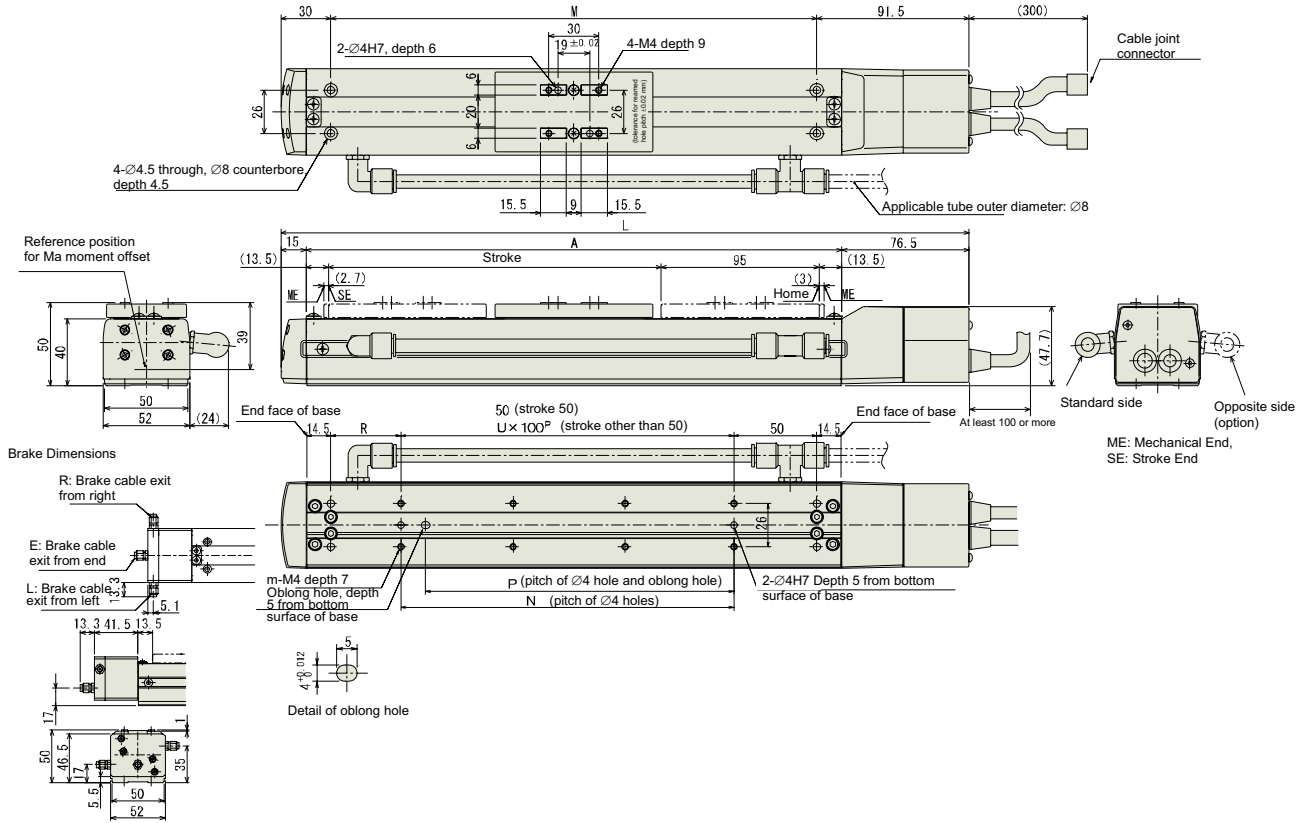

Stroke	50	100	150	200	250	300	350	400	450	500	
L	263.5	313.5	363.5	413.5	463.5	613.5	563.5	613.5	663.5	713.5	
A	172	222	272	322	372	422	472	522	572	622	
M	142	192	242	292	342	392	442	492	542	592	
N	50	100	100	200	200	300	300	400	400	500	
P	35	85	85	185	185	285	285	385	385	485	
R	42	42	92	42	92	42	92	42	92	42	
U	-	1	1	2	2	3	3	4	4	5	
m	4	4	4	6	6	8	8	10	10	12	
Weight [kg]	without brake	1.5	1.6	1.7	1.8	1.9	2.0	2.1	2.2	2.3	2.5
	with brake	1.8	1.9	2.0	2.1	2.2	2.3	2.4	2.5	2.6	2.8

12.1.23 RCS2CR-SA6D

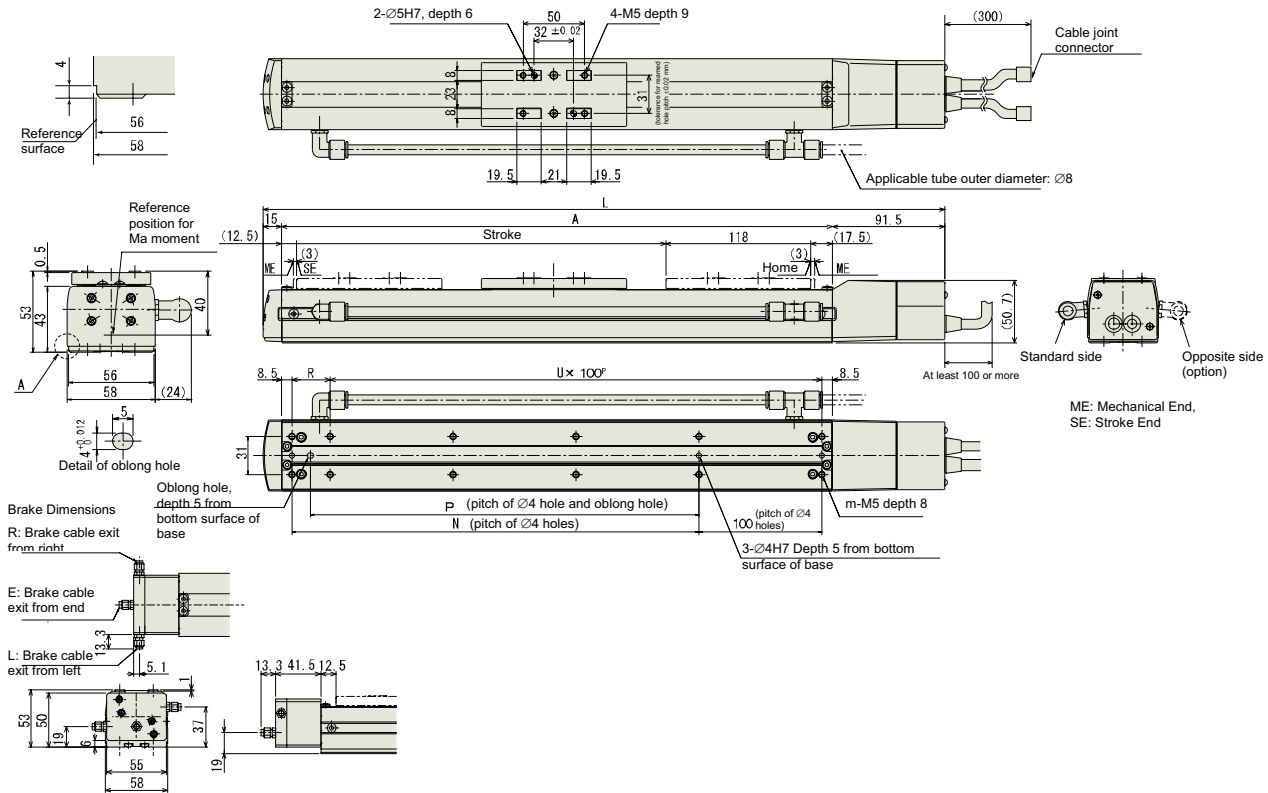

Stroke	50	100	150	200	250	300	350	400	450	500	550	600	
L	304.5	354.5	404.5	454.5	504.5	554.5	604.5	654.5	704.5	754.5	804.5	854.5	
A	198	248	298	348	398	448	498	548	598	648	698	748	
N	81	131	181	231	281	331	381	431	481	531	581	631	
P	66	116	166	216	266	316	366	416	466	516	566	616	
R	81	31	81	31	81	31	81	31	81	31	81	31	
U	1	2	2	3	3	4	4	5	5	6	6	7	
m	6	8	8	10	10	12	12	14	14	16	16	18	
Weight [kg]	without brake	2.0	2.1	2.3	2.4	2.6	2.7	2.9	3.0	3.2	3.3	3.5	3.6
	with brake	2.3	2.4	2.6	2.7	2.9	3.0	3.2	3.3	3.5	3.6	3.8	3.9

12.1.24 RCS3-SA8C, RCS3P-SA8C

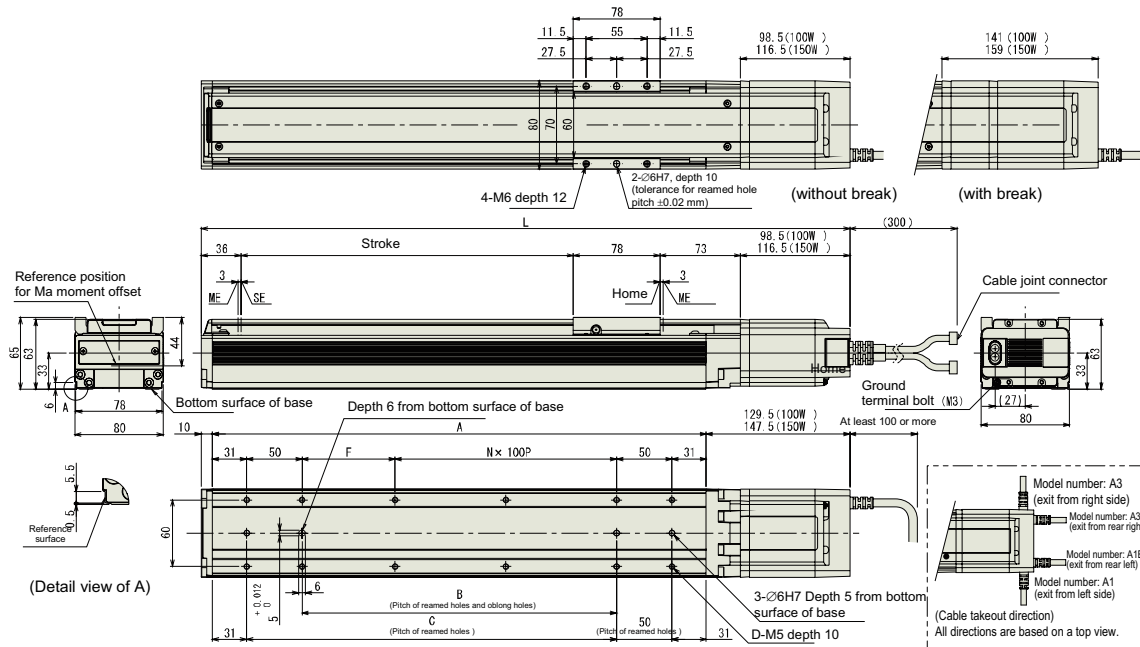

		Stroke	50	100	150	200	250	300	350	400	450	500	550	600
L	100W	without brake	335.5	385.5	435.5	485.5	535.5	585.5	635.5	685.5	735.5	785.5	835.5	885.5
		with brake	378	428	478	528	578	628	678	728	778	828	878	928
	150W	without brake	353.5	403.5	453.5	503.5	553.5	603.5	653.5	703.5	753.5	803.5	853.5	903.5
		with brake	396	446	496	546	596	646	696	746	796	846	896	946
A			196	246	296	346	396	446	496	546	596	646	696	746
B			34	84	134	184	234	284	334	384	434	484	534	584
C			84	134	184	234	284	334	384	434	484	534	584	634
D			8	8	10	10	12	12	14	14	16	16	18	18
F			34	84	34	84	34	84	34	84	34	84	34	84
N			0	0	1	1	2	2	3	3	4	4	5	5
Weight [kg]	100W	without brake	2.9	3.2	3.5	3.8	4.1	4.4	4.7	5.0	5.3	5.6	5.9	6.2
		with brake	3.3	3.6	3.9	4.2	4.5	4.8	5.1	5.4	5.7	6.0	6.3	6.6
	150W	without brake	3.0	3.3	3.6	3.9	4.2	4.5	4.8	5.1	5.4	5.7	6.0	6.3
		with brake	3.5	3.8	4.1	4.4	4.7	5.0	5.3	5.6	5.9	6.2	6.5	6.8

		Stroke	650	700	750	800	850	900	950	1000	1050	1100
L	100W	without brake	935.5	985.5	1035.5	1085.5	1135.5	1185.5	1235.5	1285.5	1335.5	1385.5
		with brake	978	1028	1078	1128	1178	1228	1278	1328	1378	1428
	150W	without brake	953.5	1003.5	1053.5	1103.5	1153.5	1203.5	1253.5	1303.5	1353.5	1403.5
		with brake	996	1046	1096	1146	1196	1246	1296	1346	1396	1446
A			796	846	896	946	996	1046	1096	1146	1196	1246
B			634	684	734	784	834	884	934	984	1034	1084
C			684	734	784	834	884	934	984	1034	1084	1134
D			20	20	22	22	24	24	26	26	28	28
F			34	84	34	84	34	84	34	84	34	84
N			6	6	7	7	8	8	9	9	10	10
Weight [kg]	100W	without brake	6.5	6.8	7.1	7.4	7.7	8.0	8.3	8.6	8.9	9.2
		with brake	6.9	7.2	7.5	7.8	8.1	8.4	8.7	9.0	9.3	9.6
	150W	without brake	6.6	6.9	7.2	7.5	7.8	8.1	8.4	8.7	9.0	9.3
		with brake	7.1	7.4	7.7	8.0	8.3	8.6	8.9	9.2	9.5	9.8

12.1.25 RCS3-SS8C, RCS3P-SS8C

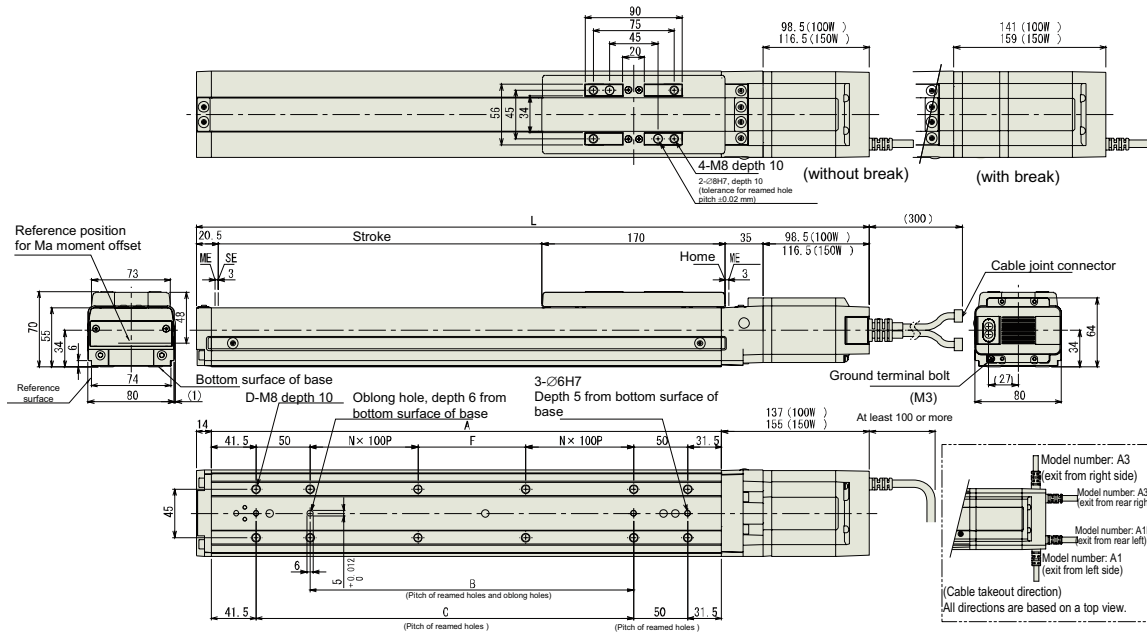

		Stroke	50	100	150	200	250	300	350	400	450	500	550	600
L	100W	without brake	374	424	474	524	574	624	674	724	774	824	874	924
		with brake	416.5	466.5	516.5	566.5	616.5	666.5	716.5	766.5	816.5	866.5	916.5	966.5
	150W	without brake	392	442	492	542	592	642	692	742	792	842	892	942
		with brake	434.5	484.5	534.5	584.5	634.5	684.5	734.5	784.5	834.5	884.5	934.5	984.5
A			223	273	323	373	423	473	523	573	623	673	723	773
B			50	100	150	200	250	300	350	400	450	500	550	600
C			100	150	200	250	300	350	400	450	500	550	600	650
D			8	8	8	10	12	12	12	14	16	16	16	18
F			50	100	150	0	50	100	150	0	50	100	150	0
N			0	0	0	1	1	1	1	2	2	2	2	3
Weight [kg]	100W	without brake	5.1	5.6	6.2	6.7	7.3	7.8	8.4	8.9	9.5	10.0	10.6	11.1
		with brake	5.5	6.0	6.6	7.1	7.7	8.2	8.8	9.3	9.9	10.4	11.0	11.5
	150W	without brake	5.1	5.7	6.2	6.8	7.3	7.9	8.4	9.0	9.5	10.1	10.6	11.2
		with brake	5.6	6.1	6.7	7.2	7.8	8.3	8.9	9.4	10.0	10.5	11.1	11.6

		Stroke	650	700	750	800	850	900	950	1000
L	100W	without brake	974	1024	1074	1124	1174	1224	1274	1324
		with brake	1016.5	1066.5	1116.5	1166.5	1216.5	1266.5	1316.5	1366.5
	150W	without brake	992	1042	1092	1142	1192	1242	1292	1342
		with brake	1034.5	1084.5	1134.5	1184.5	1234.5	1284.5	1334.5	1384.5
A			823	873	923	973	1023	1073	1123	1173
B			650	700	750	800	850	900	950	1000
C			700	750	800	850	900	950	1000	1050
D			20	20	20	22	24	24	24	26
F			50	100	150	0	50	100	150	0
N			3	3	3	4	4	4	4	5
Weight [kg]	100W	without brake	11.7	12.2	12.8	13.3	13.9	14.4	15.0	15.5
		with brake	12.1	12.6	13.2	13.7	14.3	14.8	15.4	15.9
	150W	without brake	11.7	12.3	12.8	13.4	13.9	14.5	15.0	15.6
		with brake	12.2	12.7	13.3	13.8	14.4	14.9	15.5	16.0

12.1.26 RCS3CR-SA8C, RCS3PCR-SA8C

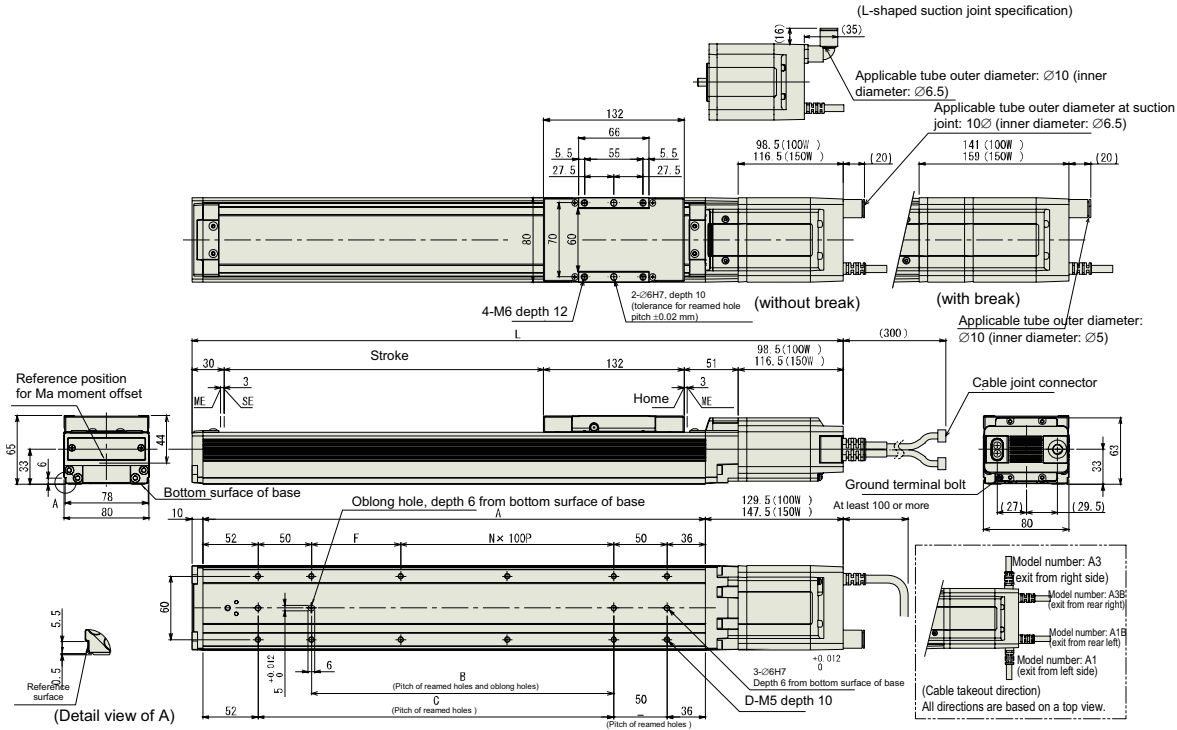

		Stroke	50	100	150	200	250	300	350	400	450	500	550	600
L	100W	without brake	361.5	411.5	461.5	511.5	561.5	611.5	661.5	711.5	761.5	811.5	861.5	911.5
		with brake	404	454	504	554	604	654	704	754	804	854	904	954
	150W	without brake	379.5	429.5	479.5	529.5	579.5	629.5	679.5	729.5	779.5	829.5	879.5	929.5
		with brake	422	472	522	572	622	672	722	772	822	872	922	972
A			222	272	322	372	422	472	522	572	622	672	722	772
B			34	84	134	184	234	284	334	384	434	484	534	584
C			84	134	184	234	284	334	384	434	484	534	584	634
D			8	8	10	10	12	12	14	14	16	16	18	18
F			34	84	34	84	34	84	34	84	34	84	34	84
N			0	0	1	1	2	2	3	3	4	4	5	5
Weight [kg]	100W	without brake	2.8	3.1	3.4	3.7	4.0	4.3	4.6	4.9	5.2	5.5	5.8	6.1
		with brake	3.2	3.5	3.8	4.1	4.4	4.7	5.0	5.3	5.6	5.9	6.2	6.5
	150W	without brake	2.9	3.2	3.5	3.8	4.1	4.4	4.7	5.0	5.3	5.6	5.9	6.2
		with brake	3.4	3.7	4.0	4.3	4.6	4.9	5.2	5.5	5.8	6.1	6.4	6.7

		Stroke	650	700	750	800	850	900	950	1000	1050	1100
L	100W	without brake	961.5	1011.5	1061.5	1111.5	1161.5	1211.5	1261.5	1311.5	1361.5	1411.5
		with brake	1004	1054	1104	1154	1204	1254	1304	1354	1404	1454
	150W	without brake	979.5	1029.5	1079.5	1129.5	1179.5	1229.5	1279.5	1329.5	1379.5	1429.5
		with brake	1022	1072	1122	1172	1222	1272	1322	1372	1422	1472
A			822	872	922	972	1022	1072	1122	1172	1222	1272
B			634	684	734	784	834	884	934	984	1034	1084
C			684	734	784	834	884	934	984	1034	1084	1134
D			20	20	22	22	24	24	26	26	28	28
F			34	84	34	84	34	84	34	84	34	84
N			6	6	7	7	8	8	9	9	10	10
Weight [kg]	100W	without brake	6.4	6.7	7.0	7.3	7.6	7.9	8.2	8.5	8.8	9.1
		with brake	6.8	7.1	7.4	7.7	8.0	8.3	8.6	8.9	9.2	9.5
	150W	without brake	6.5	6.8	7.1	7.4	7.7	8.0	8.3	8.6	8.9	9.2
		with brake	7.0	7.3	7.6	7.9	8.2	8.5	8.8	9.1	9.4	9.7

12.1.27 RCS3CR-SS8C, RCS3PCR-SS8C

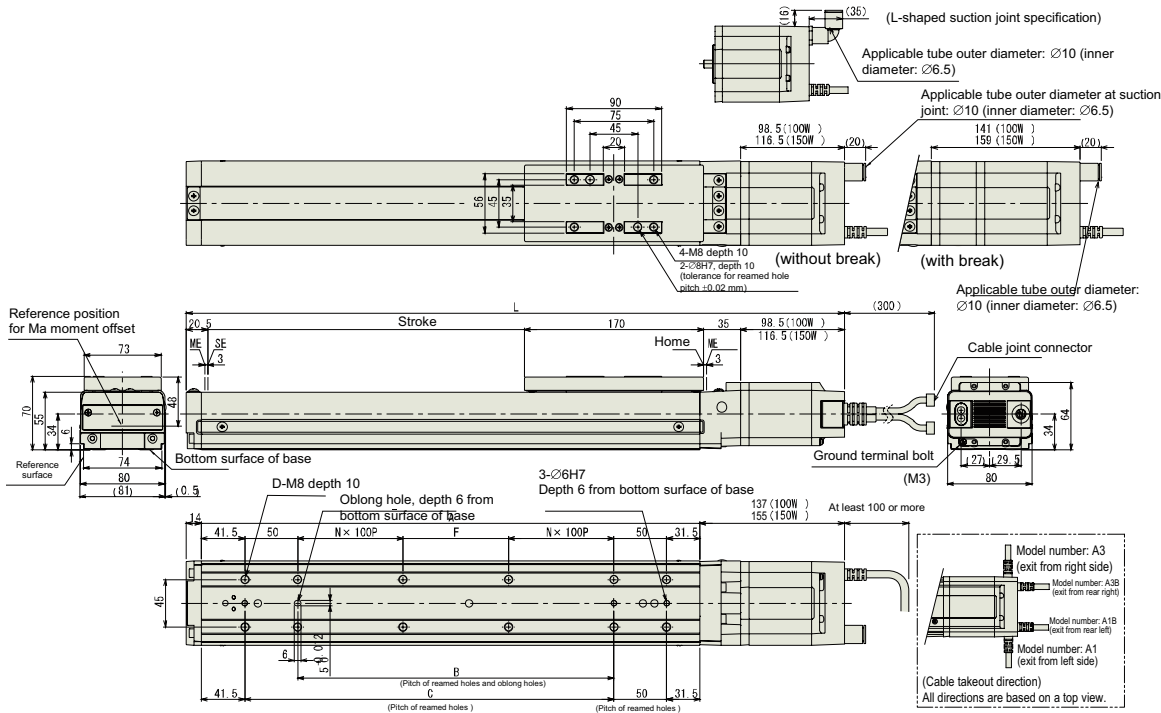

		Stroke	50	100	150	200	250	300	350	400	450	500	550	600
L	100W	without brake	374	424	474	524	574	624	674	724	774	824	874	924
		with brake	416.5	466.5	516.5	566.5	616.5	666.5	716.5	766.5	816.5	866.5	916.5	966.5
	150W	without brake	392	442	492	542	592	642	692	742	792	842	892	942
		with brake	434.5	484.5	534.5	584.5	634.5	684.5	734.5	784.5	834.5	884.5	934.5	984.5
A			223	273	323	373	423	473	523	573	623	673	723	773
B			50	100	150	200	250	300	350	400	450	500	550	600
C			100	150	200	250	300	350	400	450	500	550	600	650
D			8	8	8	10	12	12	12	14	16	16	16	18
F			50	100	150	0	50	100	150	0	50	100	150	0
N			0	0	0	1	1	1	1	2	2	2	2	3
Weight [kg]	100W	without brake	5.3	5.8	6.4	6.9	7.5	8.0	8.6	9.1	9.7	10.2	10.8	11.3
		with brake	5.7	6.2	6.8	7.3	7.9	8.4	9.0	9.5	10.1	10.6	11.2	11.7
	150W	without brake	5.3	5.9	6.4	7.0	7.5	8.1	8.6	9.2	9.7	10.3	10.8	11.4
		with brake	5.8	6.3	6.9	7.4	8.0	8.5	9.1	9.6	10.2	10.7	11.3	11.8

		Stroke	650	700	750	800	850	900	950	1000
L	100W	without brake	974	1024	1074	1124	1174	1224	1274	1324
		with brake	1016.5	1066.5	1116.5	1166.5	1216.5	1266.5	1316.5	1366.5
	150W	without brake	992	1042	1092	1142	1192	1242	1292	1342
		with brake	1034.5	1084.5	1134.5	1184.5	1234.5	1284.5	1334.5	1384.5
A			823	873	923	973	1023	1073	1123	1173
B			650	700	750	800	850	900	950	1000
C			700	750	800	850	900	950	1000	1050
D			20	20	20	22	24	24	24	26
F			50	100	150	0	50	100	150	0
N			3	3	3	4	4	4	4	5
Weight [kg]	100W	without brake	11.9	12.4	13.0	13.5	14.1	14.6	15.2	15.7
		with brake	12.3	12.8	13.4	13.9	14.5	15.0	15.6	16.1
	150W	without brake	11.9	12.5	13.0	13.6	14.1	14.7	15.2	15.8
		with brake	12.4	12.9	13.5	14.0	14.6	15.1	15.7	16.2

12.1.28 RCS3/RCS3P-SA8R

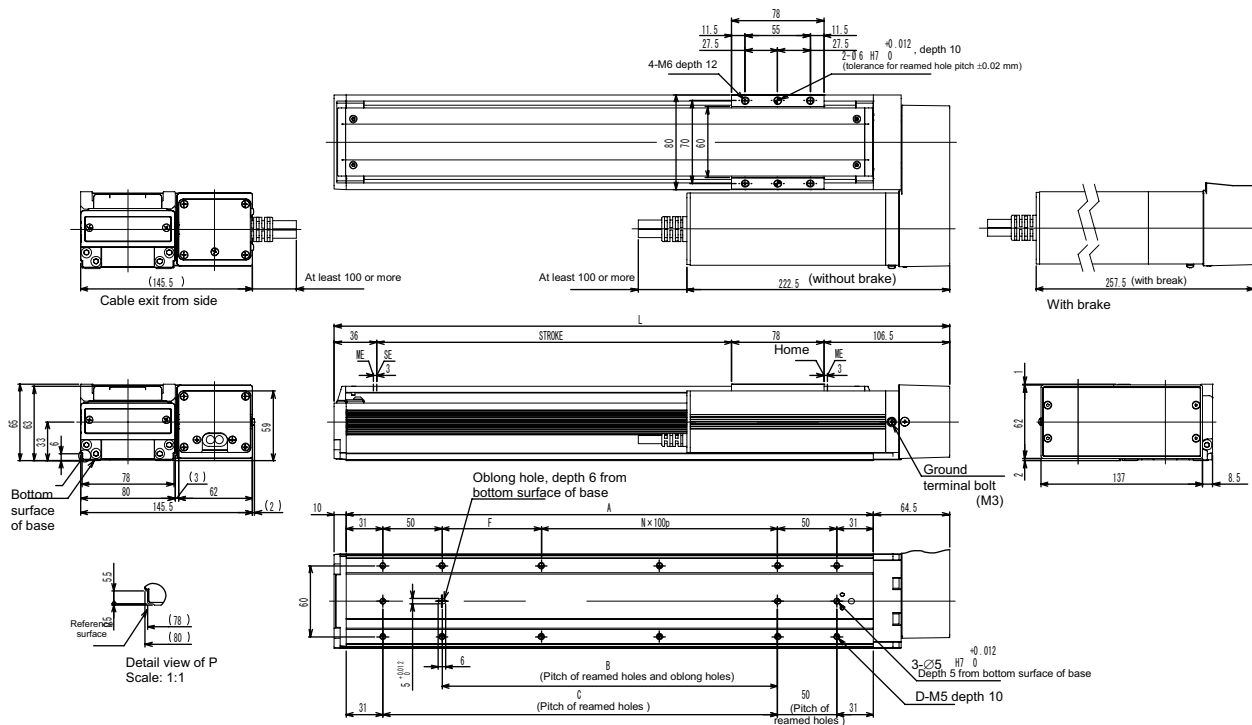

Stroke		50	100	150	200	250	300	350	400	450	500	550	600	650	700	
L		270.5	320.5	370.5	420.5	470.5	520.5	570.5	620.5	670.5	720.5	770.5	820.5	870.5	920.5	
A		196	246	296	346	396	446	496	546	596	646	696	746	796	846	
B		34	84	134	184	234	284	334	384	434	484	534	584	634	684	
C		84	134	184	234	284	334	384	434	484	534	584	634	684	734	
D		8	8	10	10	12	12	14	14	16	16	18	18	20	20	
F		34	84	34	84	34	84	34	84	34	84	34	84	34	84	
N		0	0	1	1	2	2	3	3	4	4	5	5	6	6	
Weight [kg]	100W	without brake	3.6	3.9	4.2	4.5	4.8	5.1	5.4	5.7	6.0	6.3	6.6	6.9	7.2	7.5
		with brake	4.0	4.3	4.6	4.9	5.2	5.5	5.8	6.1	6.4	6.7	7.0	7.3	7.6	7.9
	150W	without brake	3.8	4.1	4.4	4.7	5.0	5.3	5.6	5.9	6.2	6.5	6.8	7.1	7.4	7.7
		with brake	4.1	4.4	4.7	5.0	5.3	5.6	5.9	6.2	6.5	6.8	7.1	7.4	7.7	8.0

Stroke		750	800	850	900	950	1000	1050	1100	
L		970.5	1020.5	1070.5	1120.5	1170.5	1220.5	1270.5	1320.5	
A		896	946	996	1046	1096	1146	1196	1246	
B		734	784	834	884	934	984	1034	1084	
C		784	834	884	934	984	1034	1084	1134	
D		22	22	24	24	26	26	28	28	
F		34	84	34	84	34	84	34	84	
N		7	7	8	8	9	9	10	10	
Weight [kg]	100W	without brake	7.8	8.1	8.4	8.7	9.0	9.3	9.6	9.9
		with brake	8.2	8.5	8.8	9.1	9.4	9.7	10.0	10.3
	150W	without brake	8.0	8.3	8.6	8.9	9.2	9.5	9.8	10.1
		with brake	8.3	8.6	8.9	9.2	9.5	9.8	10.1	10.4

12.1.29 RCS3/RCS3P-SA8R Slider Roller Specification (Option Model Number: SR)

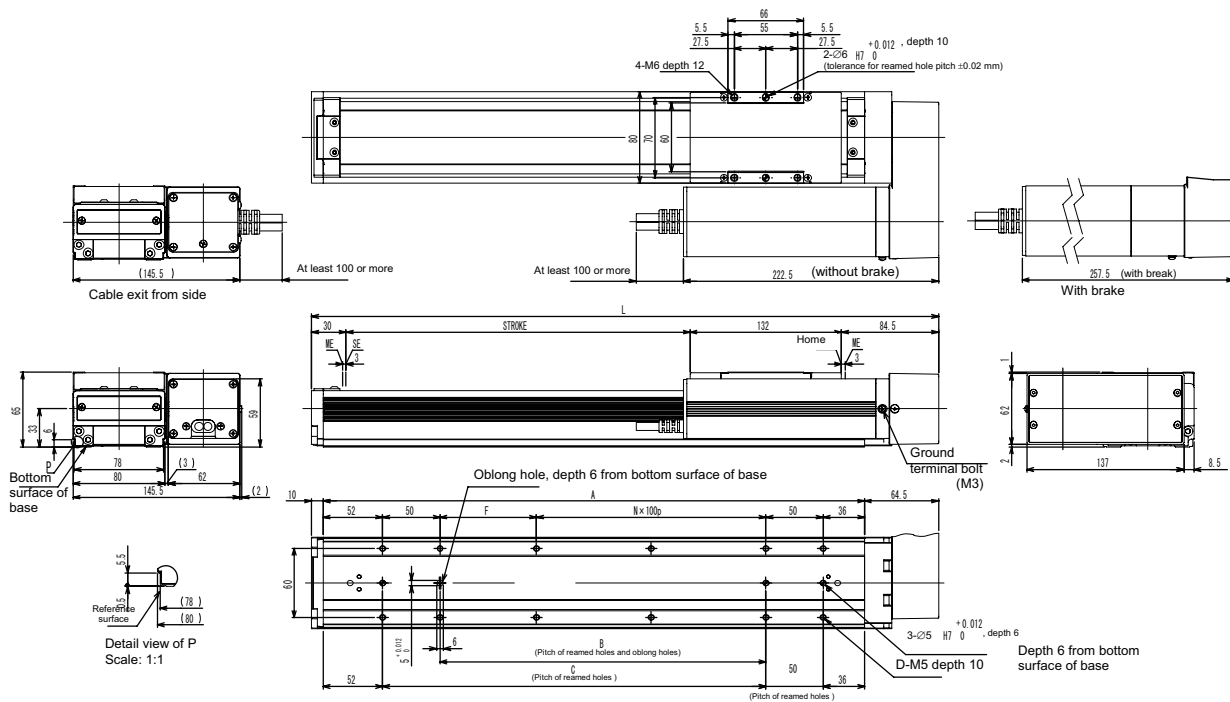

Stroke		50	100	150	200	250	300	350	400	450	500	550	600	650	700	
L		296.5	346.5	396.5	446.5	496.5	546.5	596.5	646.5	696.5	746.5	796.5	846.5	896.5	946.5	
A		222	272	322	372	422	472	522	572	622	672	722	772	822	872	
B		34	84	134	184	234	284	334	384	434	484	534	584	634	684	
C		84	134	184	234	284	334	384	434	484	534	584	634	684	734	
D		8	8	10	10	12	12	14	14	16	16	18	18	20	20	
F		34	84	34	84	34	84	34	84	34	84	34	84	34	84	
N		0	0	1	1	2	2	3	3	4	4	5	5	6	6	
Weight [kg]	100W	without brake	2.8	3.1	3.4	3.7	4.0	4.3	4.6	4.9	5.2	5.5	5.8	6.1	6.4	6.7
		with brake	3.2	3.5	3.8	4.1	4.4	4.7	5.0	5.3	5.6	5.9	6.2	6.5	6.8	7.1
	150W	without brake	2.9	3.2	3.5	3.8	4.1	4.4	4.7	5.0	5.3	5.6	5.9	6.2	6.5	6.8
		with brake	3.4	3.7	4.0	4.3	4.6	4.9	5.2	5.5	5.8	6.1	6.4	6.7	7.0	7.3

Stroke		750	800	850	900	950	1000	1050	1100	
L		996.5	1046.5	1096.5	1146.5	1196.5	1246.5	1296.5	1346.5	
A		922	972	1022	1072	1122	1172	1222	1272	
B		734	784	834	884	934	984	1034	1084	
C		784	834	884	934	984	1034	1084	1134	
D		22	22	24	24	26	26	28	28	
F		34	84	34	84	34	84	34	84	
N		7	7	8	8	9	9	10	10	
Weight [kg]	100W	without brake	7.0	7.3	7.6	7.9	8.2	8.5	8.8	9.1
		with brake	7.4	7.7	8.0	8.3	8.6	8.9	9.2	9.5
	150W	without brake	7.1	7.4	7.7	8.0	8.3	8.6	8.9	9.2
		with brake	7.6	7.9	8.2	8.5	8.8	9.1	9.4	9.7

12.1.30 RCS3/RCS3P-SS8R

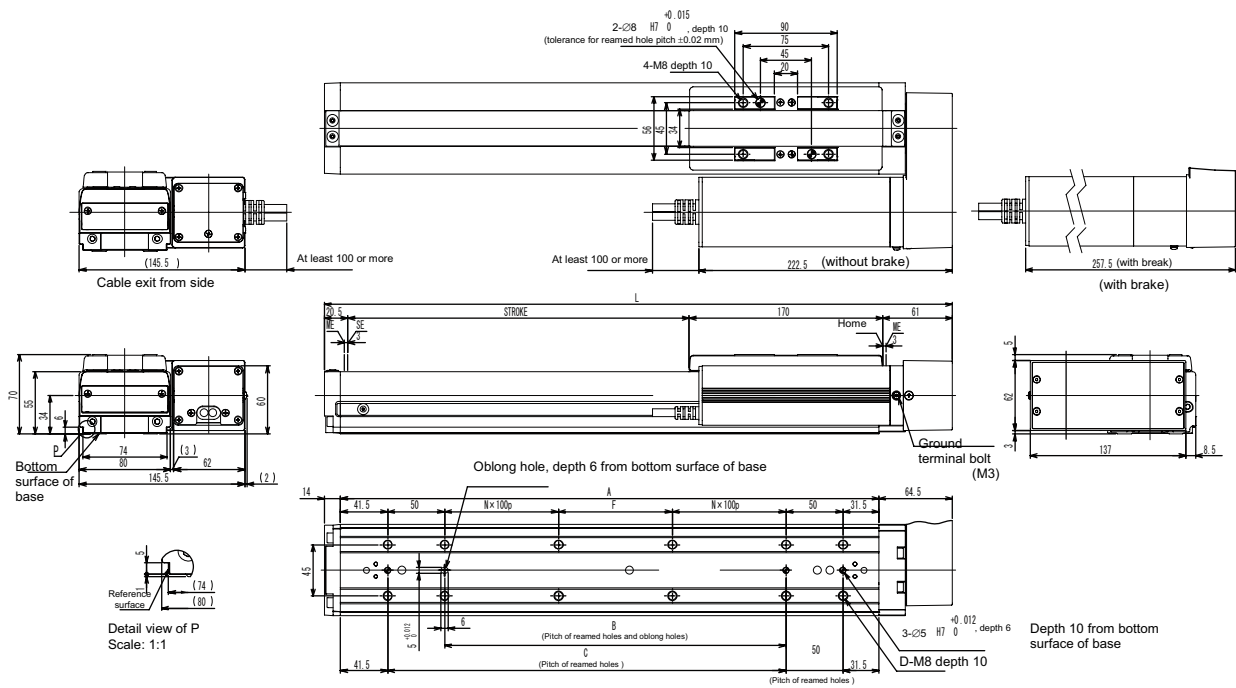

Stroke		50	100	150	200	250	300	350	400	450	500	550	600	650	700	
L		301.5	351.5	401.5	451.5	501.5	551.5	601.5	651.5	701.5	751.5	801.5	851.5	901.5	951.5	
A		223	273	323	373	423	473	523	573	623	673	723	773	823	873	
B		50	100	150	200	250	300	350	400	450	500	550	600	650	700	
C		100	150	200	250	300	350	400	450	500	550	600	650	700	750	
D		8	8	8	10	12	12	12	14	16	16	16	18	20	20	
F		50	100	150	0	50	100	150	0	50	100	150	0	50	100	
N		0	0	0	1	1	1	1	2	2	2	2	3	3	3	
Weight [kg]	100W	without brake	6.0	6.5	7.1	7.6	8.2	8.7	9.3	9.8	10.4	10.9	11.5	12.0	12.6	13.1
		with brake	6.3	6.8	7.4	7.9	8.5	9.0	9.6	10.1	10.7	11.2	11.8	12.3	12.9	13.4
	150W	without brake	6.1	6.6	7.2	7.7	8.3	8.8	9.4	9.9	10.5	11.0	11.6	12.1	12.7	13.2
		with brake	6.4	6.9	7.5	8.0	8.6	9.1	9.7	10.2	10.8	11.3	11.9	12.4	13.0	13.5

Stroke		750	800	850	900	950	1000	
L		1001.5	1051.5	1101.5	1151.5	1201.5	1251.5	
A		923	973	1023	1073	1123	1173	
B		750	800	850	900	950	1000	
C		800	850	900	950	1000	1050	
D		20	22	24	24	24	26	
F		150	0	50	100	150	0	
N		3	4	4	4	4	5	
Weight [kg]	100W	without brake	13.7	14.2	14.8	15.3	15.9	16.4
		with brake	14.0	14.5	15.1	15.6	16.2	16.7
	150W	without brake	13.8	14.3	14.9	15.4	16.0	16.5
		with brake	14.1	14.6	15.2	15.7	16.3	16.8

12.1.31 RCS3/RCS3P-SS8R Slider Roller Specification (Option Model Number: SR)

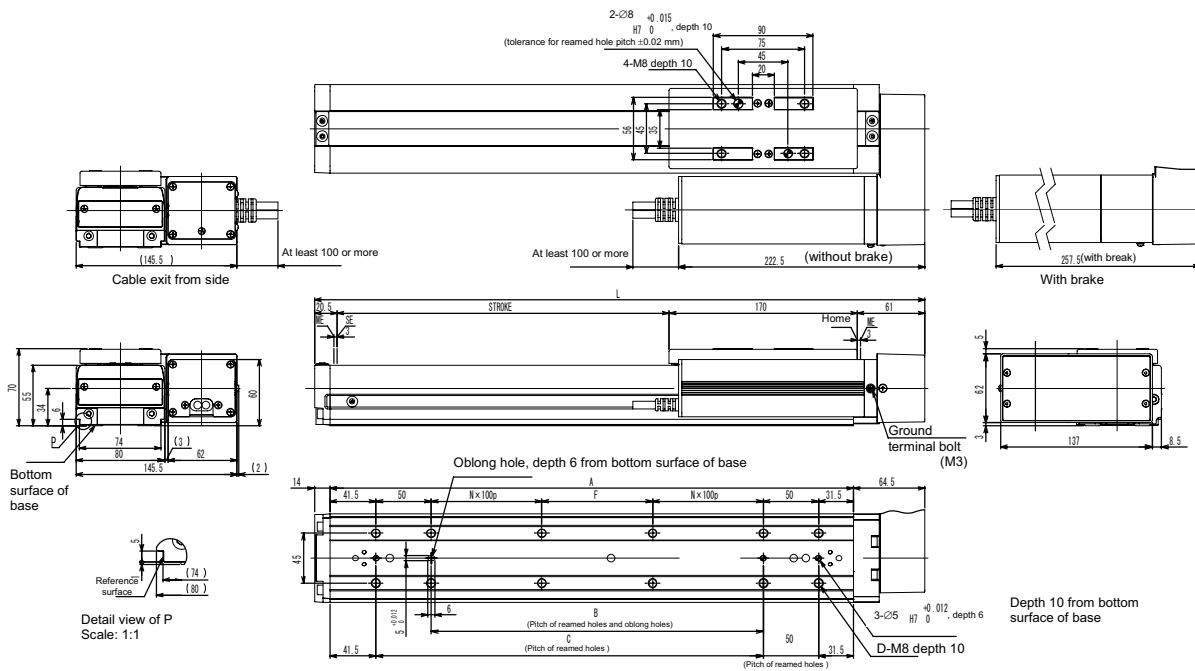

Stroke	50	100	150	200	250	300	350	400	450	500	550	600	650	700		
L	301.5	351.5	401.5	451.5	501.5	551.5	601.5	651.5	701.5	751.5	801.5	851.5	901.5	951.5		
A	223	273	323	373	423	473	523	573	623	673	723	773	823	873		
B	50	100	150	200	250	300	350	400	450	500	550	600	650	700		
C	100	150	200	250	300	350	400	450	500	550	600	650	700	750		
D	8	8	8	10	12	12	12	14	16	16	16	18	20	20		
F	50	100	150	0	50	100	150	0	50	100	150	0	50	100		
N	0	0	0	1	1	1	1	2	2	2	2	3	3	3		
Weight [kg]	100W	without brake	5.3	5.8	6.4	6.9	7.5	8.0	8.6	9.1	9.7	10.2	10.8	11.3	11.9	12.4
	100W	with brake	5.7	6.2	6.8	7.3	7.9	8.4	9.0	9.5	10.1	10.6	11.2	11.7	12.3	12.8
Weight [kg]	150W	without brake	5.3	5.9	6.4	7.0	7.5	8.1	8.6	9.2	9.7	10.3	10.8	11.4	11.9	12.5
	150W	with brake	5.8	6.3	6.9	7.4	8.0	8.5	9.1	9.6	10.2	10.7	11.3	11.8	12.4	12.9

Stroke	750	800	850	900	950	1000		
L	1001.5	1051.5	1101.5	1151.5	1201.5	1251.5		
A	923	973	1023	1073	1123	1173		
B	750	800	850	900	950	1000		
C	800	850	900	950	1000	1050		
D	20	22	24	24	24	26		
F	150	0	50	100	150	0		
N	3	4	4	4	4	5		
Weight [kg]	100W	without brake	13.0	13.5	14.1	14.6	15.2	15.7
	100W	with brake	13.4	13.9	14.5	15.0	15.6	16.1
Weight [kg]	150W	without brake	13.0	13.6	14.1	14.7	15.2	15.8
	150W	with brake	13.5	14.0	14.6	15.1	15.7	16.2

13. Warranty

13.1 Warranty Period

One of the following periods, whichever is shorter:

- 18 months after shipment from IAI
- 12 months after delivery to the specified location
- 2,500 hours of operation

13.2 Scope of Warranty

Our products are covered by warranty when all of the following conditions are met. Faulty products covered by warranty will be replaced or repaired free of charge:

- (1) The breakdown or problem in question pertains to our product as delivered by us or our authorized dealer.
- (2) The breakdown or problem in question occurred during the warranty period.
- (3) The breakdown or problem in question occurred while the product was in use for an appropriate purpose under the conditions and environment of use specified in the operation manual and catalog.
- (4) The breakdown or problem in question was caused by a specification defect or problem, or by the poor quality of our product.

Note that breakdowns due to any of the following reasons are excluded from the scope of warranty:

- [1] Anything other than our product
- [2] Modification or repair performed by a party other than us (unless we have approved such modification or repair)
- [3] Anything that could not be easily predicted with the level of science and technology available at the time of shipment from our company
- [4] A natural disaster, man-made disaster, incident or accident for which we are not liable
- [5] Natural fading of paint or other symptoms of aging
- [6] Wear, depletion or other expected result of use
- [7] Operation noise, vibration or other subjective sensation not affecting function or maintenance

Note that the warranty only covers our product as delivered and that any secondary loss arising from a breakdown of our product is excluded from the scope of warranty.

13.3 Honoring the Warranty

As a rule, the product must be brought to us for repair under warranty.

13.4 Limited Liability

- (1) We shall assume no liability for any special damage, consequential loss or passive loss such as a loss of expected profit arising from or in connection with our product.
- (2) We shall not be liable for any program or control method created by the customer to operate our product or for the result of such program or control method.

13.5 Conditions of Conformance with Applicable Standards/Regulations, Etc., and Applications

- (1) If our product is combined with another product or any system, device, etc., used by the customer, the customer must first check the applicable standards, regulations and/or rules. The customer is also responsible for confirming that such combination with our product conforms to the applicable standards, etc. In such a case we will not be liable for the conformance of our product with the applicable standards, etc.
- (2) Our product is for general industrial use. It is not intended or designed for the applications specified below, which require a high level of safety. Accordingly, as a rule our product cannot be used in these applications. Contact us if you must use our product for any of these applications:
 - [1] Medical equipment pertaining to maintenance or management of human life or health
 - [2] A mechanism or mechanical equipment intended to move or transport people (such as a vehicle, railway facility or aviation facility)
 - [3] Important safety parts of mechanical equipment (such as safety devices)
 - [4] Equipment used to handle cultural assets, art or other irreplaceable items
- (3) Contact us at the earliest opportunity if our product is to be used in any condition or environment that differs from what is specified in the catalog or operation manual.

13.6 Other Items Excluded from Warranty

The price of the product delivered to you does not include expenses associated with programming, the dispatch of engineers, etc. Accordingly, a separate fee will be charged in the following cases even during the warranty period:

- [1] Guidance for installation/adjustment and witnessing of test operation
- [2] Maintenance and inspection
- [3] Technical guidance and education on operating/wiring methods, etc.
- [4] Technical guidance and education on programming and other items related to programs

Change History

Revision Date	Description of Revision	
May 2010	Fifth edition	Added information on RCS3 and RCS3CR actuators.
June 2010	Sixth edition	<p>P. 25 Changed the maximum speed of RCS3 and RCS3CR at lead 30. 1790 mm/s → 1800 mm/s</p> <p>P. 56 Changed the rates of suction. SS8, lead 10 mm: 90 NI/min → 80 NI/min SS8, lead 30 mm (speed not exceeding 1500 mm/s): 150 NI/min → 160 NI/min SS8, lead 30 mm (speed exceeding 1500 mm/s): 190 NI/min (added)</p>
November 2010	Seventh edition	<p>Important Note Added "Adding Grease on the Clean Room Specification."</p> <p>P. 9 Added 6, "Do Not Loosen the Mounting Screws of Micro-Switches or Bend the Switch Dogs" under "Handling Precautions."</p> <p>P. 19 Added 2, "Motor/Encoder Cables." Added note *1.</p> <p>P. 23 Added options "VL" and "VN."</p> <p>P. 24 to 32 Added SA5 and SA6 specifications of lead 20.</p> <p>P. 36 Added (7), "Actuator precision."</p> <p>P. 37 Added 3, "Life."</p> <p>P. 54 Added [Connecting to SCON/SSEL Controller] and [Connecting to X-SEL Controller].</p> <p>P. 57 to 64 Added 7, "Setting the Home."</p> <p>P. 66 to 68 Added 9, "Options."</p> <p>P. 73 Added 11.4, "Adjusting the Stainless Sheet."</p> <p>P. 189 Added 11.10.10, "Replacing the Motor of the Motor Straight Type (Built-in Type)."</p> <p>P. 190 Added 12, "Appendix – External Dimensions."</p>
April 2011	Eighth edition	<p>P. 9 Change made to duty calculation</p>
May 2011	Ninth edition	<p>P. 25, 26 TA added to encoder types, Caution added</p>
June 2011	Tenth edition	<p>P. 44 Contents of caution for vertically oriented mount changed.</p>
July 2011	Eleventh edition	<p>P. 44 Change in ceiling installation availability (×: Not installable → △: Daily inspection is required)</p> <p>P. 232 to 233 Contents changed in 13. Warranty</p>

Revision Date	Description of Revision	
December 2011	Twelfth edition	Contents changed in Safety Guide Caution notes added for when working with two or more persons P. 44 to 58 Note added to state that RCS2CR-SA5D and RCS2CR-SA6D cannot be ensured for Cleanliness Class 10 in vertical orientation, horizontally oriented wall mount or in ceiling mount.
March 2012	Thirteenth edition	P. 1 to 7 Contents added and changed in Safety Guide P. 8 Handling Precautions added P. 27 Correction made to maximum speed for SS7 P. 88 to 90 Warning notes added such as in case the grease got into your eye, immediately go to see the doctor for an appropriate care. P. 201 to 231 Weight added to appearance drawing
May 2012	Fourteenth edition	P. 94, 198 Gap checking tool became a plate and figure corrected
September 2012	Fifteenth edition	P.1 to P.7 Additions and Changes made in Safety Guide contents P.13 International Standards Compliances added P.26, 27 CE: Complied with CE Mark added to “How to Read Model Code” option. P.46 Caution notes added for RCS3-SA8C/R horizontally oriented wall mount and ceiling mount
November 2012	Sixteenth edition	P. 126 to 137 Change made in motor replacement process for RCS2-SA4C, SA5C and SA6C
January 2013	Seventeenth edition	P. 9 “High Acceleration/Deceleration Type LF = 330%” added in graph layout
April 2013	Eighteenth edition	P. 150 to 157 Added instruction how to replace motor for RCS2-SS8C Rigid Coupling Type

Revision Date	Description of Revision
April 2013	Nineteenth edition P. 89 Correction made from lithium-based grease to urea-based grease in warning sentence P. 239 Dimensions changed in bottom view of the base 129.5 (100W) → 137 (100W) 147.5 (150W) → 155 (150W)
October 2013	Twentieth edition P. 78 Note corrected CB-X2-PA □□□ → CB-X3-PA □□□
January 2014	Twenty-first Edition Contents added for RCS2-SA4C Lead 16 and RCS2-SA7C Lead 24 in 1.4 How to Read Model Code and 2. Specifications.



IAI Corporation

Head Office: 577-1 Obane Shimizu-KU Shizuoka City Shizuoka 424-0103, Japan
TEL +81-54-364-5105 FAX +81-54-364-2589
website: www.iai-robot.co.jp/

Technical Support available in USA, Europe and China

IAI America, Inc.

Head Office: 2690 W. 237th Street, Torrance, CA 90505
TEL (310) 891-6015 FAX (310) 891-0815
Chicago Office: 1261 Hamilton Parkway, Itasca, IL 60143
TEL (630) 467-9900 FAX (630) 467-9912
Atlanta Office: 1220 Kennestone Circle, Suite 108, Marietta, GA 30066
TEL (678) 354-9470 FAX (678) 354-9471
website: www.intelligentactuator.com

IAI Industrieroboter GmbH

Ober der Röth 4, D-65824 Schwalbach am Taunus, Germany
TEL 06196-88950 FAX 06196-889524

IAI (Shanghai) Co., Ltd.

SHANGHAI JIAHUA BUSINESS CENTER A8-303, 808, Hongqiao Rd. Shanghai 200030, China
TEL 021-6448-4753 FAX 021-6448-3992
website: www.iai-robot.com

IAI Robot (Thailand) Co., Ltd.

825 PhairojKijja Tower 12th Floor, Bangna-Trad RD., Bangna, Bangkok 10260, Thailand
TEL +66-2-361-4458 FAX +66-2-361-4456