



Techcon

SYSTEMS



Your Liquid
Asset

Dispensing Valves & Equipment



ABOUT TECHCON

For over 40 years, Techcon Systems has been a leading manufacturer of fluid dispensing systems. Techcon's components are used in medical, automotive, telecommunications, aerospace, electronics and industrial applications throughout the world, helping improve manufacturing processes and dispense quality results that your customers demand.

Techcon offers a wide array of fluid dispensing products and provides dispensing components ranging from disposable accessories to complete microprocessor-controlled dispensing systems, and precision valves.

Our wide array of fluid dispensing valves ranges from simple manual dispensing to precision valves for high speed automated applications. Plus, we have the specific controllers necessary to operate the different valves.

And, being a part of the OK International family of products, Techcon has a strong global sales channel, with direct subsidiaries in France, Germany, Italy, UK, China, Japan and Taiwan.

If you value quality like we do, you'll understand why businesses have depended on Techcon's quality manufacturing for reliable products that fit your budget. Techcon Systems is your liquid asset.



TABLE OF CONTENTS

	Page
Valve Application Guide	2
Range Overview	3
Rotary Valves	4
Diaphragm Valves	6
Spray Valves	8
Needle Valves	10
Spool Valves	12
Pinch Tube Valves	14
Pressure Pots	15
Accessories and Fittings	16
Stainless Steel Needles	17
Typical Set Up	17
Valve Controllers	18
Techcon Product Range	20

APPLICATION GUIDE

FLUIDS	APPLICATIONS					
	MICRODOTS	DOTS	LINES/BEADS	POTTING ENCAPSULATION	PACKAGING FILLING	SPRAY
Activators	TS5440	TS5420	TS5420		TS5622VU	TS5520 TS5540
Alcohol	TS5440	TS5420	TS5420		TS5420	TS5520 TS5540
Anaerobics	TS5622VU	TS5622VU	TS5622VU		TS5622VU	
Conformal Coatings		TS5622VU	TS5622VU	TS5622VU	TS5322	TS5520 TS5540
Cyanoacrylates	TS5622VU	TS5622VU	TS5622VU TS1212		TS5622VU TS1212	
Epoxies	TS5000	TS5000 TS5000DMP	TS5000DMP	TS5000DMP	TS941	
Flux (liquid)	TS5440	TS5622VU	TS5622VU		TS5322	TS5520 TS5540
Flux (paste)	TS5440	TS5322	TS5322		TS5322	
Greases	TS5000	TS5000DMP	TS5000DMP		TS941	
Inks	TS5440	TS5420	TS5420		TS5322	TS5520 TS5540
Lacquers	TS5622VU-DVD	TS5622VU-DVD	TS5622VU-DVD		TS5622VU-DVD	TS5520 TS5540
Mold Releases	TS5440	TS5622VU	TS5622VU		TS5322	TS5520 TS5540
Oils	TS5440	TS5622VU	TS5622VU		TS5322	TS5520 TS5540
Paints	TS5440	TS5622VU	TS5622VU		TS5322	TS5520 TS5540
Reagent	TS5440	TS5622VU	TS5622VU		TS5622VU	TS5520 TS5540
RTV Silicone	TS5000	TS5322	TS5322 TS941	TS5322 TS941	TS5322 TS941	
Solder Masks		TS5322	TS5322		TS5322	
Solder Pastes	TS5000	TS5000	TS5000		TS941	
Solvents	TS5440	TS5622VT	TS5622VT		TS5622VT	TS5520 TS5540
Two-part Adhesive	TS5000DMP	TS5000DMP	TS5000DMP	TS5000DMP TS1212	TS1212	
UV-cure Adhesive (liquid)	TS5440	TS5622VU-DVD	TS5622VU-DVD	TS5622VU-DVD	TS5622VU-DVD	
UV-cure Adhesive (Gel)	TS5000DMP	TS5000DMP	TS5000DMP	TS5000DMP	TS5322D	
UV-cure with Anaerobic	TS5622VD	TS5622VD	TS5622VD	TS5622VD	TS5622VD	

Blank = NOT APPLICABLE

NEEDLE VALVES

MINI/SPOOL VALVES











DIAPHRAGM VALVES

SPRAY VALVES

ROTARY VALVES

DISPENSE PEN & PINCH TUBE VALVE

RANGE OVERVIEW

		CONTROLLERS						
		DX-300 Digital Dispenser/ Controller 	TS9701/ TS9765 Memory Digital Dispensers 	TS5130 Pneumatic Valve Controller 	TS9150G Precision Dispensing System 	TS5100 Rotary Valve Controller 	TS5110 Spray Valve Controller 	TS1258 Pressure Pot 
VALVES	TS5000DMP TS5000 Rotary Valves 							
	TS5420 TS5420SS Needle Valves 							
	TS5440 Microshot Needle Valve 							
	TS5322 TS5322D Mini Spool Valves 							
	TS941 TS941A Spool Valves 							
	TS5600 Series Diaphragm Valves 							
	TS1212 Pinch Tube Valve 							
	TS5623 Series Hand Held Diaphragm Valves 							
	TS1201 Dispense Pen 							
	TS5520 Spray Valves 							

Blue = Recommended

ROTARY VALVES



▲ **TS5000DMP - performing underfill.**

In addition to the 5000 Series, the unique DMP (Disposable Material Path) cap valve offers a choice of 3 different feed screws sizes (6, 8 and 16-pitch), all made of Delrin®. The DMP Valve has a hinged doorway that opens easily so the disposable auger can be removed, disposed of, and replaced within seconds, while the line is still in operation. Therefore, the DMP significantly reduces downtime and waste. The choice of left, right or center hinged openings makes the valve suitable for mounting on most automated systems.

Optional encoder motors are available for closed loop feed back requirement. ►

TS5000 Series

The Rotary Valves use a rotary feed screw (auger) to dispense fluid with a positive displacement action, allowing for ultra-precise control of the dispensing process. The unique design ensures that material is constantly present at the feed screw inlet while the controlled rotation of the feed screw moves the material from the feed to the discharge point. This allows for precise dispensing of two-part products without the danger of separation. Discrete control of the forward and reverse rotations of the feed screw controls the amount of material discharged.

The 5000 Series offers a comprehensive range of options including motors with 2 different wattages, 3 reduction ratios and an encoding option. There are 4 different choices for body material and 12 choices of feed screws. This variety enables you to make the correct valve selection for any given application.





TS5000
Precision
Rotary Valve



TS5000DMP
Disposable
Material Path
Rotary Valve

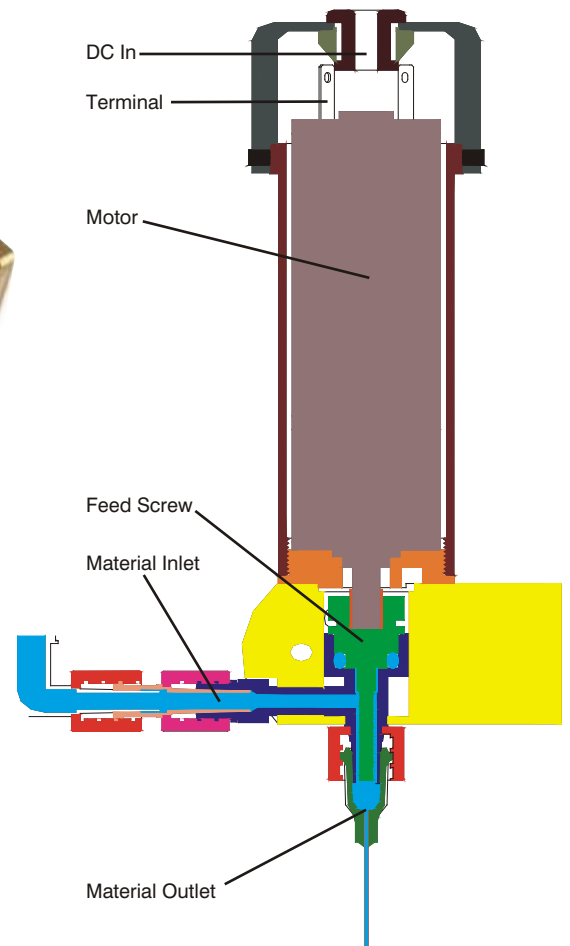

Typical Applications:

Solder paste, die attach, surface mount adhesive, chip encapsulation, dam writing

Key Features:

- Precise and consistent shot sizes
- Motor reverse capability
- Field replaceable wetted parts (For DMP version)
- Adjustable dispense rate
- Wide variety of configurations

Recommended Controller:

TS5100 Rotary Valve Controller.

For complete information on the TS5100 Rotary Valve Controller, please see page 19.



▲ TS5000 Right hand opening. Left and front door opening also available.



▲ TS5000 Disposable path available in 3 different pitches, DMP6-10, DMP8-10, DMP16-10, in packs of 10.



▲ TS-SS Precision Metal Needles, see page 17.

VALVE	SIZE AND WEIGHT	WETTED PARTS	MAXIMUM FLUID PRESSURE	ACTIVATION PRESSURE	CONNECTIONS	MOUNTING	RECOMMENDED VISCOSITY RANGE
TS5000 3-Watt	L: 4.02" (102mm) W: 2.12" (54mm) Weight: 0.4lb (180g)	Depending on exact configuration	30 psi (2.1bar)	NA	Inlet: Female Luer Lock Outlet: Male Luer Lock	1.0" wide channel	30k-130k cps
TS5000 6-Watt	L: 5.4" (137mm) W: 2.5" (64mm) Weight: 0.6lb (270g)	Depending on exact configuration	30 psi (2.1bar)	NA	Inlet: Female Luer Lock Outlet: Male Luer Lock	1.0" wide channel	30k-130k cps
TS5000DMP	L: 5.4" (142mm) W: 3" (76mm) Weight: 0.77lb (340g)	Delrin®, Viton® Celcon®	30 psi (2.1bar)	NA	Inlet: Female Luer Lock Outlet: Male Luer Lock	1.0" wide channel	30k-130k cps

DIAPHRAGM VALVES

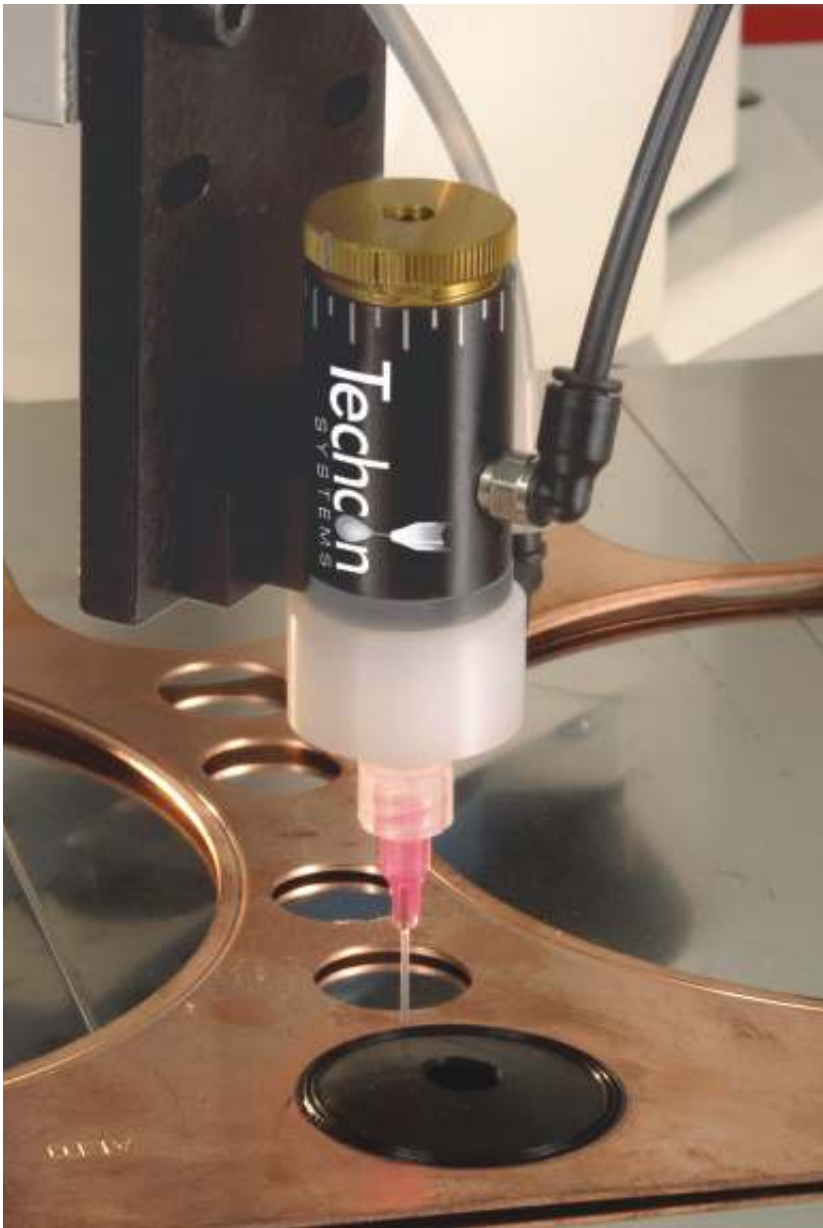

▲ TS5622

A stainless steel version with optimized internal fluid route is especially dedicated to UV-cure adhesives, resins and lacquers used in the manufacture of DVDs and CDs.

The valves are low maintenance; easy-to-use, easy-to-maintain with user replaceable spare parts. Hand-held actuated valve is also available.

TS5600 Series

Diaphragm Valves are designed to dispense low to medium viscosity materials with precision accuracy over a wide range of shot and bead sized down to a fraction of a micro-liter. An internal return spring makes the valves fully adaptable for use with Techcon Systems time/pressure controllers. A short opening stroke provides extremely fast, positive shut-off. An external stroke control adjustment makes it easy for the operator to fine tune shot sizes. The compact design with both horizontal and vertical mounting geometries allows for mounting flexibility and easy integration into automated applications.

Body in Ultra High Molecular Weight Polyethylene (UHMWPE) for most of the application but we offer Teflon® for chemical compatibility, and Delrin® for UV-curable.



TS5623 Hand-held Diaphragm Valve for manual application of adhesive. ►

TS5621
Diaphragm
Valves
(Horizontal Valve)



TS5622VU-DVD
Diaphragm
Valves



TS5622
Diaphragm
Valves
(Vertical Valve)

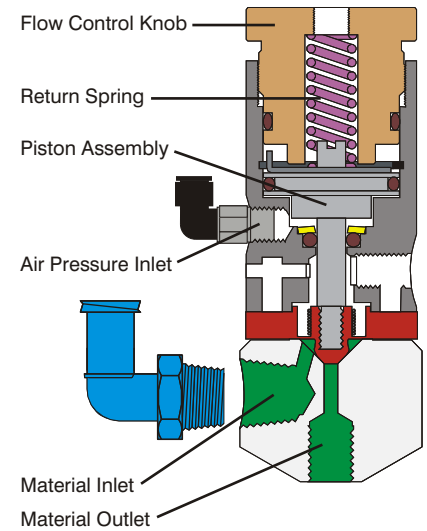

Typical Applications:

Dispense wide range shot sizes of low viscosity fluids such as: cyanoacrylates, anaerobics, liquid fluxes, solvents, UV-cure adhesives, resins and lacquers.

Key Features:

- Excellent moisture sensitive resistant
- Adjustable stroke control
- Simple and low maintenance design
- Compact size and weight
- Long life cycles

Recommended Controller:

DX-300, TS5130, TS9701 and TS9765. The TS1258 Pressure Pot is recommended for use with all Diaphragm Valves.

TS5622VU-DVD - spin coating application.



VALVE	SIZE AND WEIGHT	WETTED PARTS	MAXIMUM FLUID PRESSURE	ACTIVATION PRESSURE	CONNECTIONS	MOUNTING	RECOMMENDED VISCOSITY RANGE
TS5620HU	L: 2.4"(61mm) D:0.94"(24mm) Weight: 0.13lb(61g)	UHMWPE	70 psi (4.8 bar)	70 psi (4.8 bar)- 90 psi (6.3 bar)	Inlet: 1/4-28 UNF Outlet: 1/4-28 UNF	10-32 UNF	1-50k cps
TS5620HT	L: 2.4"(61mm) D:0.94"(24mm) Weight: 0.13lb(61g)	Teflon®	70 psi (4.8 bar)	70 psi (4.8 bar)- 90 psi (6.3 bar)	Inlet: 1/4-28 UNF Outlet: 1/4-28 UNF	10-32 UNF	1-50k cps
TS5621HD	L: 2.4"(61mm) D:0.94"(24mm) Weight: 0.14lb(63g)	UHMWPE, Delrin®	70 psi (4.8 bar)	70 psi (4.8 bar)- 90 psi (6.3 bar)	Inlet: 1/8" NPT Outlet: 1/8"NPT	10-32 UNF	1-50k cps
TS5622VU	L: 2.6"(66mm) D:1.06"(27mm) Weight: 0.15lb(66g)	UHMWPE	70 psi (4.8 bar)	70 psi (4.8 bar)- 90 psi (6.3 bar)	Inlet: 1/8" NPT Outlet: 1/4-28 UNF	10-32 UNF	1-50k cps
TS5622VD	L: 2.6"(66mm) D:1.06"(27mm) Weight: 0.15lb(66g)	UHMWPE, Delrin®	70 psi (4.8 bar)	70 psi (4.8 bar)- 90 psi (6.3 bar)	Inlet: 1/8" NPT Outlet: 1/4-28 UNF	10-32 UNF	1-50k cps
TS5622VT	L: 2.6"(66mm) D:1.06"(27mm) Weight: 0.15lb(66g)	Teflon®	70 psi (4.8 bar)	70 psi (4.8 bar)- 90 psi (6.3 bar)	Inlet: 1/8" NPT Outlet: 1/4-28 UNF	10-32 UNF	1-50k cps
TS5623HU	L: 3.47"(88mm) D:1.06"(27mm) Weight: 0.25lb(116g)	UHMWPE	70 psi (4.8 bar)	NA	Inlet: 1/8" NPT Outlet: 1/4-28 UNF	NA	1-50k cps
TS5623HD	L: 3.47"(88mm) D:1.06"(27mm) Weight: 0.25lb(116g)	UHMWPE, Delrin®	70 psi (4.8 bar)	NA	Inlet: 1/8" NPT Outlet: 1/4-28 UNF	NA	1-50k cps
TS5623HT	L: 3.47"(88mm) D:1.06"(27mm) Weight: 0.25lb(116g)	Teflon®	70 psi (4.8 bar)	NA	Inlet: 1/8" NPT Outlet: 1/4-28 UNF	NA	1-50k cps

SPRAY VALVES



▲ *TS5520 - spray marking on metal work.*

TS5540 Spray Valve - spray lubricant on feed screw. ►

TS5500 Series

The Spray Valves are designed for precise spray applications of low to medium viscosity materials. An external stroke control makes it easy for the operator to fine-tune fluid flow. Total control of the spray cycle is provided by adjustable fluid flow and precise control of pre-spray, atomizing air and post spray with the TS5110 Spray Valve Controller. Maintenance is made simple by the elimination of troublesome spring loaded needle packing. Downtime is virtually eliminated with only one seal to replace during normal maintenance.

The new TS5540 spray valves come with stainless steel construction in both air cylinder and fluid housing. A field replaceable Teflon® seat provides positive shut off and very long life cycles.

The compact design and easy-mount threaded hole allow for easy integration into automated applications.

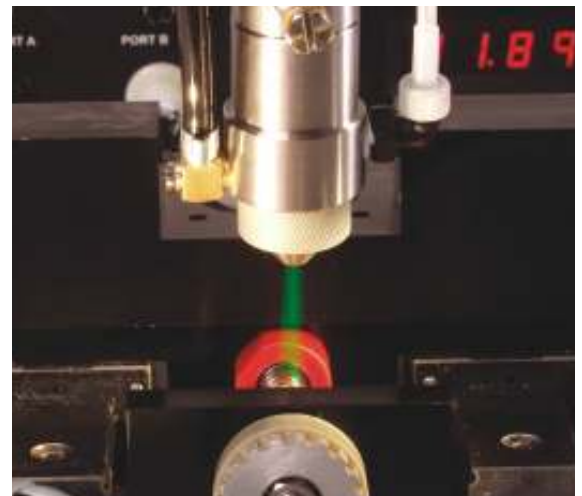



TS5520
Spray Valve



TS5540
Spray Valve



TS5540F
Spray Valve

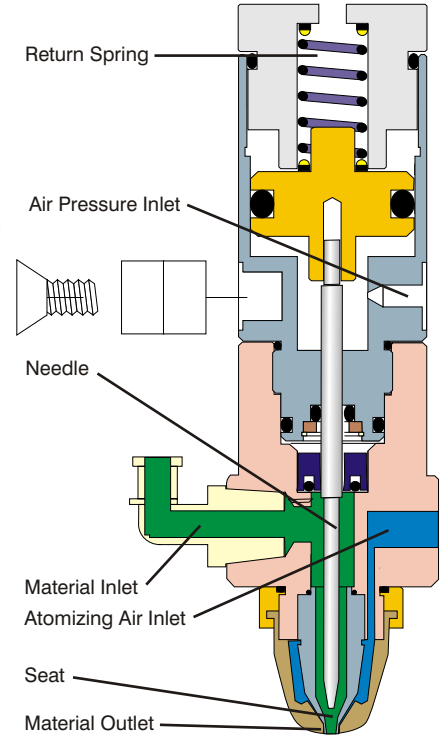

Typical Applications:

To spray fine mist of low viscosity fluids such as: conformal coating, solvent, oil, etc.

Key Features:

- Consistent spray coverage
- Adjustable flow control
- No overspray
- Long life cycles
- Positive shut-off

Recommended Controller:

TS5110 Spray Valve Controller.

For complete information on the TS5110 Spray Valve Controller, please see page 19.



TS5110
Spray Valve Controller



Nozzles:

	OPENING DIAMETER	CONE NOZZLE	FAN NOZZLE
TS5520	0.046" (1.17mm)	(standard)	F
TS5540	0.014" (.356mm) 0.028" (.711mm) 0.046" (1.17mm)	014R 028R 046R	014F 028F 046F

VALVE	SIZE AND WEIGHT	WETTED PARTS	MAXIMUM FLUID PRESSURE	ACTIVATION PRESSURE	CONNECTIONS	MOUNTING	RECOMMENDED VISCOSITY RANGE
TS5520	L: 4.2" (107mm) D: 1.12" (28mm) Weight: 0.3lb (136g)	303 SS, Teflon®, Anodized Al, EPR	100 psi (6.9 bar)	70 psi (4.8 bar) Minimum	Inlet: 1/8" NPT Outlet: Spray nozzle	1/4-20UNC-2B	1-1k cps
TS5540	L: 4.2" (107mm) D: 1.12" (28mm) Weight: 0.74lb (336g)	303 SS, Teflon®	100 psi (6.9 bar)	70 psi (4.8 bar) Minimum	Inlet: 1/8" NPT Outlet: Spray nozzle	1/4-20UNC-2B	1-10k cps

NEEDLE VALVES



▲ *TS5420 - precision filling.*

TS5400 Series

Needle Valves dispense very precise deposits over a wide range of shot and bead sizes due to a minimal dead fluid zone. An external stroke control adjustment to fine-tune shot sizes. Easy to maintain, with little or no downtime. The compact design and easy-mount threaded hole allows for easy integration into automated applications.

The TS5420 Adjustable Needle Valve is a pneumatically triggered single-acting valve that can be used with an internal spring close (single acting) or may be connected for air closing without the spring (double acting). The TS5440 Microshot Needle Valve, with its needle closing the fluid path directly on the canula inside the needle body, can dispense very precise deposits down to 0.0005 cm^3 .

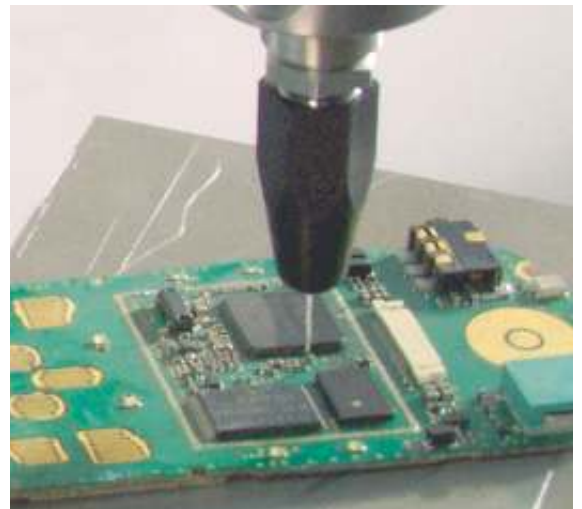

TS5440 - glob top. ►



TS5420
Needle Valve



TS5440
Microshot
Needle Valve

Typical Applications:

To dispense microdots of low viscosity fluids such as: solvents, inks, oils, activators, primers; the TS5440 is excellent to dispense microdots of UV adhesive used in medical device manufacturing.

Key Features:

- Precise and consistent shot sizes
- Zero dead fluid zone
- Adjustable flow control
- Simple and low maintenance design

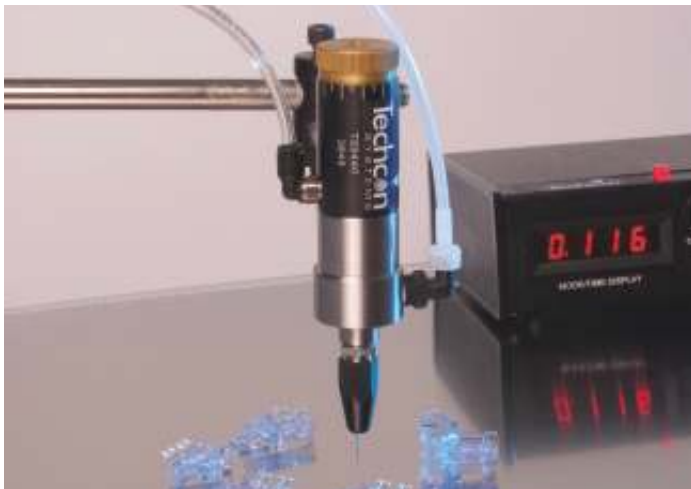

▲ **TS5440 - precision gluing on medical devices.**

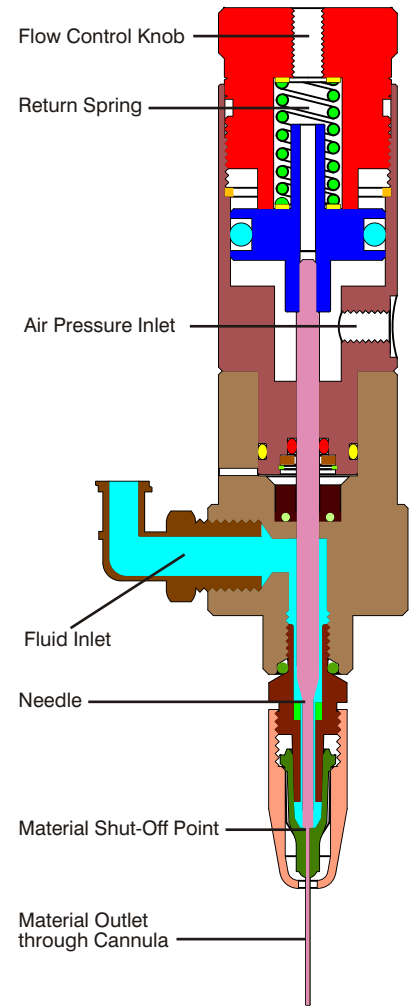

Recommended Controller:

DX-300, TS5130, TS9765 and TS9701.

VALVE	SIZE AND WEIGHT	WETTED PARTS	MAXIMUM FLUID PRESSURE	ACTIVATION PRESSURE	CONNECTIONS	MOUNTING	RECOMMENDED VISCOSITY RANGE
TS5420	L: 4.4" (112mm) D: 1.12" (28mm) Weight: 0.3lb (136g)	303 SS, Anodized Al, Teflon®, EPR	300 psi (20.7 bar)	70 psi (4.8 bar) Minimum	Inlet: 1/8" NPT Outlet: Male Luer Lock	1/4-20UNC-2B	1-100k cps
TS5420SS	L: 4.4" (112mm) D: 1.12" (28mm) Weight: 0.5lb (227g)	303 SS, Teflon®, EPR	300 psi (20.7 bar)	70 psi (4.8 bar) Minimum	Inlet: 1/8" NPT Outlet: Luer Lock	1/4-20UNC-2B	1-100k cps
TS5440	L: 5.0" (127mm) D: 1.12" (28mm) Weight: 0.5lb (227g)	303 SS, Teflon®	100 psi (6.9 bar)	70 psi (4.8 bar) Minimum	Inlet: 1/8" NPT Outlet: Luer Lock	10-32 UNF	1-100k cps

SPOOL VALVES

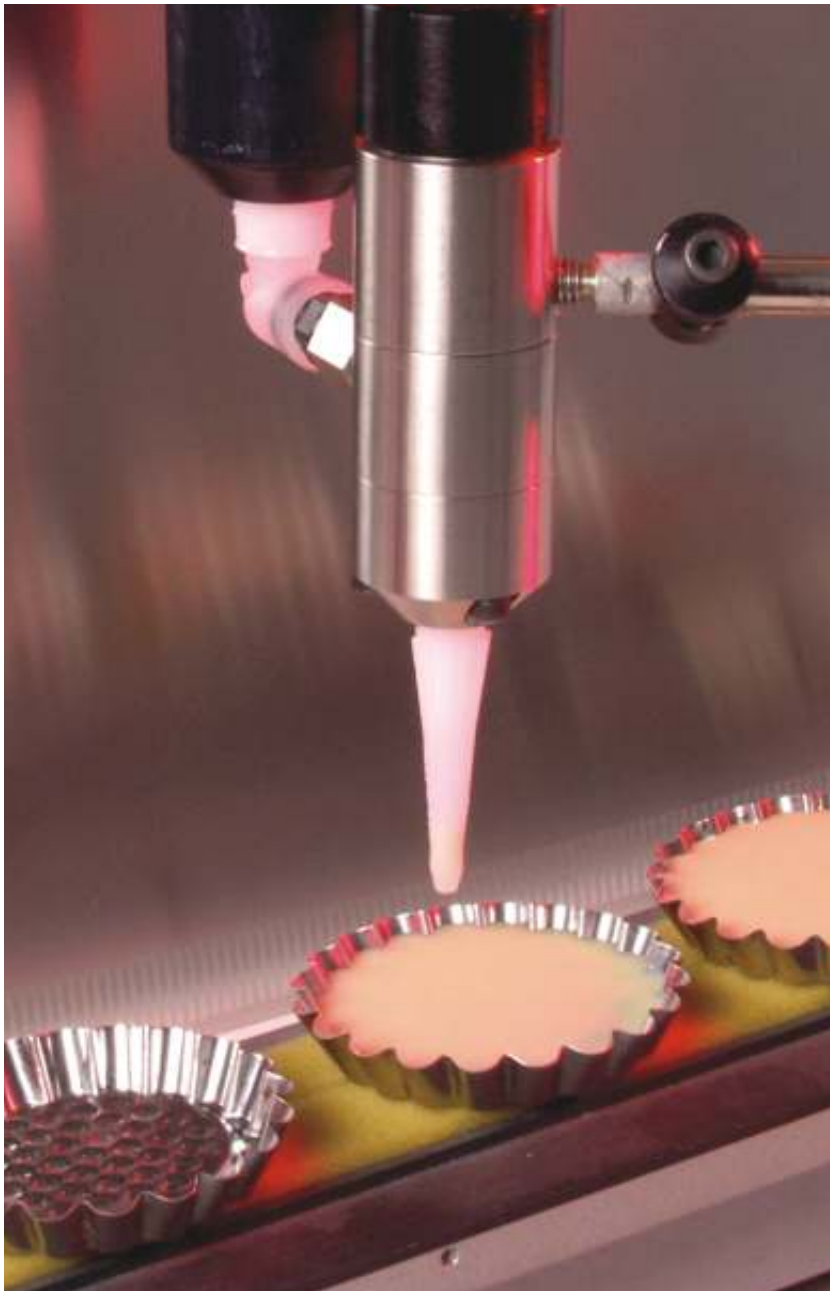

▲ *TS941 - high-speed filling.*

TS5300 Mini Spool Valve Series

The Mini Spool Valve series is designed for better accuracy with lower pressure. This series operates like the TS941 in a smaller size.

Output is a 1/8" NPT.

TS5322- gasketing. ►

TS941 High Pressure Spool Valve

The Spool Valves provide precise shot accuracy along with “high volume” capacity over a range of material viscosities, shot sizes and pressures. They feature “suck-back” anti-drip as well as a fast on/off dispensing function that is not affected by material input pressure. An optional oil chamber creates an additional liquid seal to prevent moisture from being carried on the spool, excellent for moisture sensitive materials. Pneumatically activated, the valves can be used with an internal spring close (single acting) or an air-closing connection (double acting).

Output is a 1/4" NPT allowing multiple tip termination. This is the only valve type which allows multiple types of tip to be used.





TS941
Spool Valve



TS5322
Mini Spool Valve

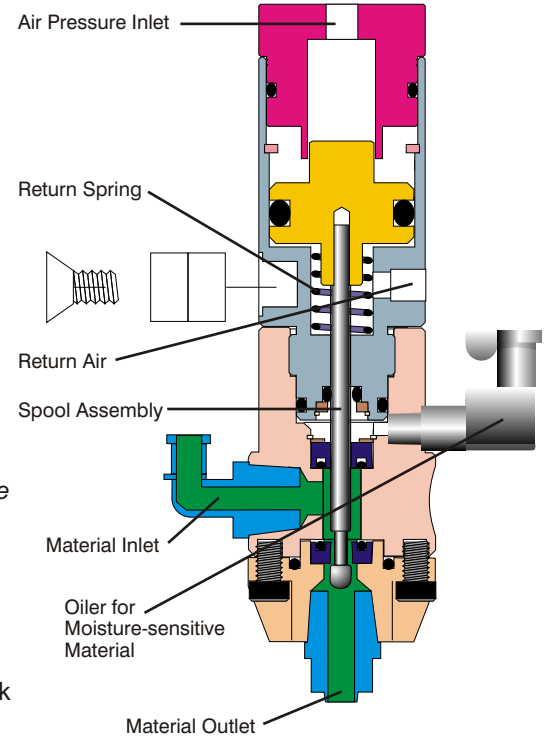

Typical Applications:

To dispense dots and beads of medium to high viscosity fluids such as: RTV silicone for form-in-place gasket; grease for lubrication, solder mask, etc.

Key Features:

- TS941 withstands high fluid pressure up to 2500 psi
- End-of-cycle suck-back
- Simple and low maintenance design
- Fast flow rate

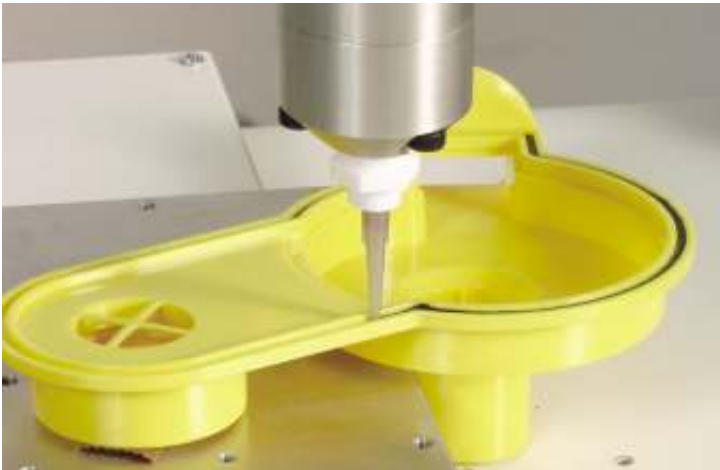

▲ **TS941 - gasketing.**

Recommended Controller:

TS5130 Smart Pneumatic Valve Controller.

DX-300, TS9701 and TS9765.

VALVE	SIZE AND WEIGHT	WETTED PARTS	MAXIMUM FLUID PRESSURE	ACTIVATION PRESSURE	CONNECTIONS	MOUNTING	RECOMMENDED VISCOSITY RANGE
TS5322	L: 4.0" (102mm) D: 1.38" (35mm) Weight: 0.31lb (141g)	303 SS, Anodized Al, Teflon®, EPR	500 psi (34.5 bar)	70 psi (4.8 bar) Minimum	Inlet: 1/8" NPT Outlet: 1/8" NPT	1/4-20UNC-2B	5k-1000k cps
TS5322D	L: 4.0" (102mm) D: 1.38" (35mm) Weight: 0.26lb (118g)	303 SS, Delrin®, Teflon®, EPR	500 psi (34.5 bar)	70 psi (4.8 bar) Minimum	Inlet: 1/8" NPT Outlet: 1/8" NPT	1/4-20UNC-2B	5k-1000k cps
TS941	L: 4.7" (119mm) D: 1.5" (38mm) Weight: 1.6lb (726g)	303 SS, UHMWPE, EPR	2500 psi (172 bar)	70 psi (4.8 bar) Minimum	Inlet: 3/8" NPT Outlet: 1/4"NPT	1.50" Diameter	5k-3000k cps

PINCH TUBE VALVES



TS1201 Dispense Pen

The TS1201 Dispense Pen uses a disposable molded tube assembly. By pressing the handle, the operator releases the piece pinching the tube. Designed to handle a wide variety of fluids — from adhesives and lubricants to sealants and masks. Gravity or pressure fed, the pen has a built-in shot and flow rate control for repeatability. Includes pre-assembled applicator pen, two clear and two black spare pinch tube assemblies, an assortment of disposable dispensing tips and a 24" hose. Replacement pinch tube assemblies sold in packs of ten.

Typical Applications:

Cyanoacrylates, anaerobics, two-part adhesive, etc.

Key Features:

- Disposable fluid path
- Compact size and weight
- Simple to operate

Recommended Pressure Pot:

TS1258

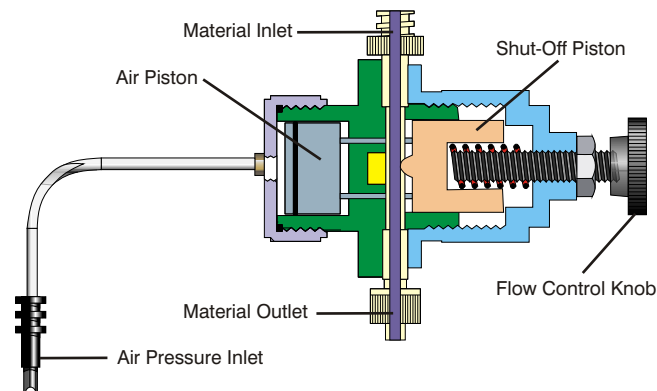

TS1212 Pneumatic Pinch Tube Valve

The TS1212 Pneumatic Pinch Tube Valve provides control for continuous or micro shot applications of low to semi-viscous fluids. The "ON/OFF" control is achieved by automatically opening and closing (pinching) a molded polyethylene tube assembly. Adjusting the opening size of the pinch tube assembly determines the shot size or flow rate. The air-actuated valve can be timed to develop specific shot sizes. The only part of the valve making contact with the fluid being dispensed is the disposable pinch tube assembly.

Typical Applications:

Cyanoacrylates, anaerobic, two-part adhesive, etc.

Key Features:

- Disposable fluid path
- Compact size and weight
- Simple to operate



Recommended Controller:

TS9150G, TS9701, TS5130 and DX-300.

Spare pinch tube for TS1212 (Pack of 10)			
1212-004-000PK	Natural	Ø 0.07" (1.8mm)	male to female
1212-004-002BPK	Black	Ø 0.1" (2.54mm)	male to female
1212-004-002PK	Natural	Ø 0.1" (2.54mm)	male to female
1212-004-003PK	New	Ø 0.1" (2.54mm)	male to female
1212-004-100BPK	Black	Ø 0.1.25" (3.16mm)	male to female
1212-004-100HPK	Hi-Duro		
1212-004-100PK	PP	Ø 0.1.25" (3.16mm)	male to female
1212-004-200PK	PP	Ø 0.1.25" (3.16mm)	male to female

VALVE	SIZE AND WEIGHT	WETTED PARTS	MAXIMUM FLUID PRESSURE	ACTIVATION PRESSURE	CONNECTIONS	MOUNTING	RECOMMENDED VISCOSITY RANGE
TS1201	L: 5" (127mm) W: 1.34" (34mm) Weight: 0.08 lb (36g)	Polyethylene (Standard) Polyurethane (Optional)	60 psi (4.1 bar)	NA	Inlet: Female Luer Lock Outlet: Male Luer Lock	NA	1-45k cps
TS1212	L: 3.25" (83mm) D: 1.58" (40mm) Weight: 0.18lb (830g)	Polyethylene (Standard) Polyurethane (Optional)	60 psi (4.1 bar)	30 psi (2.1 bar) Minimum	Inlet: Female Luer Lock Outlet: Male Luer Lock	1/4-20UNC-2B	1-45k cps

PRESSURE POTS



TS1258 Pressure Pot

Techcon Systems' TS1258 Pressure Pot (High Pressure, 100 psi) is designed to accommodate all solvent and epoxy fluids, as well as CA's and UV's. It will also accommodate black fittings and tubing in 1/4", 3/8", and 4 mm, with stainless steel compression fittings for a continuous fluid path from the reservoir inside the pot to the point of use. Airtight seals ensure no leak points or air entrapment problems.

100 psi operating pressure easily handles fluid with viscosity up to 50,000 cps. Disposable polyethylene dip tube and supply lines can be quickly changed. The pressure gauge and pressure regulator are located on top for easy reading and access. Includes 1/4" fluid line kit.

SPECIFICATIONS

Size:	9.3" x 11.2" x 15.1" (236 x 284 x 384mm)
Chamber:	6.1" I.D. x 11.0" H (155 x 279mm)
Weight:	21 lbs. (9.5 kg)
Max Operating Pressure:	100 psi (7 bar)

AVAILABLE FLUID LINE KITS:

TS1252-4MM	4mm O.D. tube
TS1258-250	1/4" (6.35mm) O.D. tube
TS1258-375	3/8" (9.5mm) O.D. tube

TS1251E - A smaller 0.5 liter version pressure pot is also available. ▶



TS918-46 Four-way Manifold

Designed to provide equal-flow for up to four fluid paths, the TS918-46 is used whenever precision fluid flow to multiple stations is required. And, the manifold can be used with any Techcon Fluid Dispensing Valve. The TS918-46 works with the TS1258 Pressure Pot (TS1258-375 Hose Kit required to use TS918-46 and TS1258 together).



SPECIFICATIONS

Size:	2.6" X 2.2" (66 X 56mm)
Inlet port:	3/8"NPT (1/4" O.D. tube fitting is included)
Outlet port:	1/8" NPT (4 Luer Lock fittings are included)
Max Operating Pressure:	100 psi (7 bar)

ACCESSORIES & FITTINGS

Fluid Line Assemblies

Each polyethylene hose assembly is provided with a molded luer lock fitting on one or both ends. The assembly can be used with other standard luer lock connectors and will handle up to 100 psi working pressure.

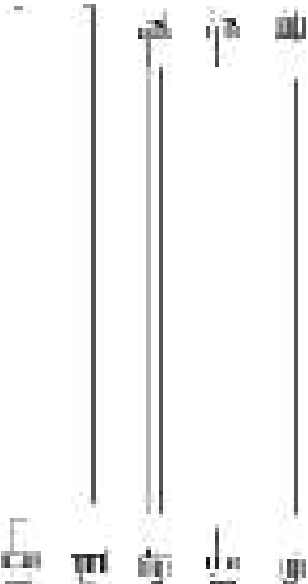

PART NUMBER	SIZE	CONNECTION	MATERIAL
TSD126-118PK	0.100"(2.54mm) X 18"(457mm)	Male Luer/open	Natural PE
TSD126-124PK	0.100"(2.54mm) X 24"(610mm)	Male Luer/open	Natural PE
TSD126-136PK	0.100"(2.54mm) X 36"(914mm)	Male Luer/open	Natural PE
TSD126-218PK	0.100"(2.54mm) X 18"(457mm)	Female Luer/open	Natural PE
TSD126-224PK	0.100"(2.54mm) X 24"(610mm)	Female Luer/open	Natural PE
TSD126-236PK	0.100"(2.54mm) X 36"(914mm)	Female Luer/open	Natural PE
TSD126-318PK	0.100"(2.54mm) X 18"(457mm)	Male Luer/female Luer	Natural PE
TSD126-318BPK	0.100"(2.54mm) X 18"(457mm)	Male Luer/female Luer	Black PE
TSD126-324PK	0.100"(2.54mm) X 24"(610mm)	Male Luer/female Luer	Natural PE
TSD126-324BPK	0.100"(2.54mm) X 24"(610mm)	Male Luer/female Luer	Black PE
TSD126-336PK	0.100"(2.54mm) X 36"(914mm)	Male Luer/female Luer	Natural PE
TSD126-336BPK	0.100"(2.54mm) X 36"(914mm)	Male Luer/female Luer	Black PE
TSD126-360BPK	0.100"(2.54mm) X 18"(457mm)	Male Luer/female Luer	Black PE
TSD126-418PK	0.100"(2.54mm) X 18"(457mm)	Female Luer/female Luer	Natural PE
TSD126-424PK	0.100"(2.54mm) X 24"(610mm)	Female Luer/female Luer	Natural PE
TSD126-436PK	0.100"(2.54mm) X 36"(914mm)	Female Luer/female Luer	Natural PE
TSD126-524PK	0.100"(2.54mm) X 24"(610mm)	Male Luer/male Luer	Natural PE

Luer Lock Fittings

All 931 Series fittings are molded and have good chemical resistance to solvents, acids and resin fluids. The locking end accepts all standard dispensing needle tips and molded fitting used on the TSD126 Series hose assemblies. For a complete list, see your Techcon representative.

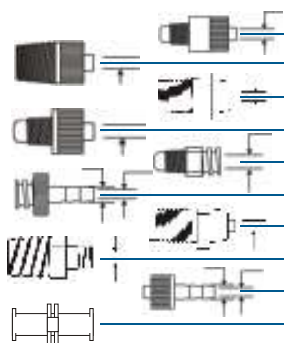

PART NUMBER	DESCRIPTION	MATERIAL
TSD931-5	Male Luer Lock to 5/16-28	White Acetal
TSD931-6	Male Luer Lock to 1/8" NPT	White Acetal
TSD931-7	Male Luer Lock to 1/4" NPT	White Polypropylene
TSD931-8	Male Luer Lock to 1/4-32	White Acetal
TSD931-9	Female Luer Lock to 1/4-32	White Acetal
TSD931-13	Female Luer Lock to Hose Barb	White Acetal
TSD931-14	Male Luer Lock to 1/4" NPT	Black Polypropylene
TSD931-15	Female Luer Lock to 1/4" NPT	Black Nylon/Acetal
TSD931-17	Male Luer Lock to Hose Barb	White Acetal
TSD931-28	Female Luer Lock to Female Luer Lock	Natural Polypropylene

Compression Fittings & Tubes

Compression fittings and tubes provide secure connection and increase fluid flow.



PART NUMBER	DESCRIPTION	MATERIAL
TSD1003-16	1/8" O.D. X 1/4"	Black Polypropylene
TSD1002-17	1/8" O.D. X 3/8" I.D. tube	Black Polypropylene
TSD1002-18	1/8" NPT to 1/4" O.D. tube fitting	Black Polypropylene
TSD1566-5	1/4" NPT to 3/8" O.D. tube fitting	Black Polypropylene
TSD1099-22	3/8" O.D. X 1/4" I.D. tube	Black Polypropylene
TSD1099-23	3/8" O.D. X 1/4" I.D. tube	Clear Polypropylene
TSD1099-24	1/4" O.D. X 1/8" I.D. tube	Clear Polypropylene
TSD1099-25	1/4" O.D. X 1/8" I.D. tube	Black Polypropylene

TS-SS Needles

TS-SS Series Precision Metal Dispensing Needles designed with high degree of precisions and tolerances to use in automated applications. Recommended for use with TS5000 Series valves.

Cannula is stainless steel; Hub is made of nickel plated brass. Length is 1/2" (12.7mm). Sold in packs of 12.

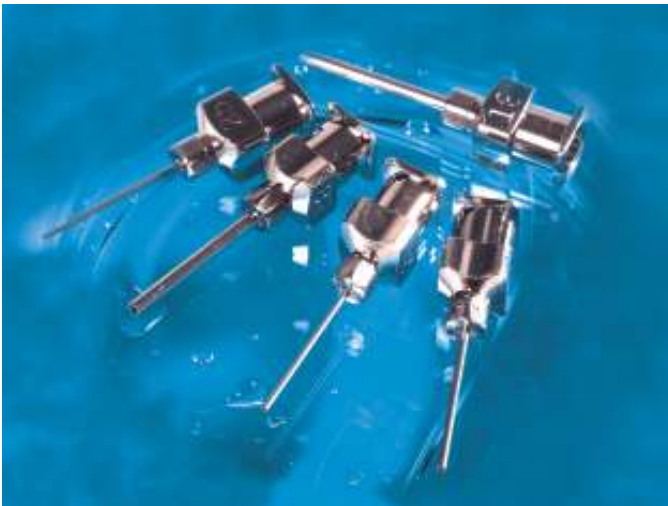

Part Number	Gauge	I.D. (inches)	I.D. (mm)
TS14SS-1/2	14	0.063	1.60
TS15SS-1/2	15	0.054	1.37
TS16SS-1/2	16	0.047	1.193
TS17SS-1/2	17	0.041	1.073
TS18SS-1/2	18	0.033	0.838
TS19SS-1/2	19	0.028	0.711
TS20SS-1/2	20	0.024	0.609
TS21SS-1/2	21	0.020	0.508
TS22SS-1/2	22	0.016	0.406
TS23SS-1/2	23	0.013	0.330
TS25SS-1/2	25	0.010	0.254
TS26SS-1/2	26	0.010	0.254
TS27SS-1/2	27	0.008	0.203
TS28SS-1/2	28	0.007	0.172

Typical Valve Set Up

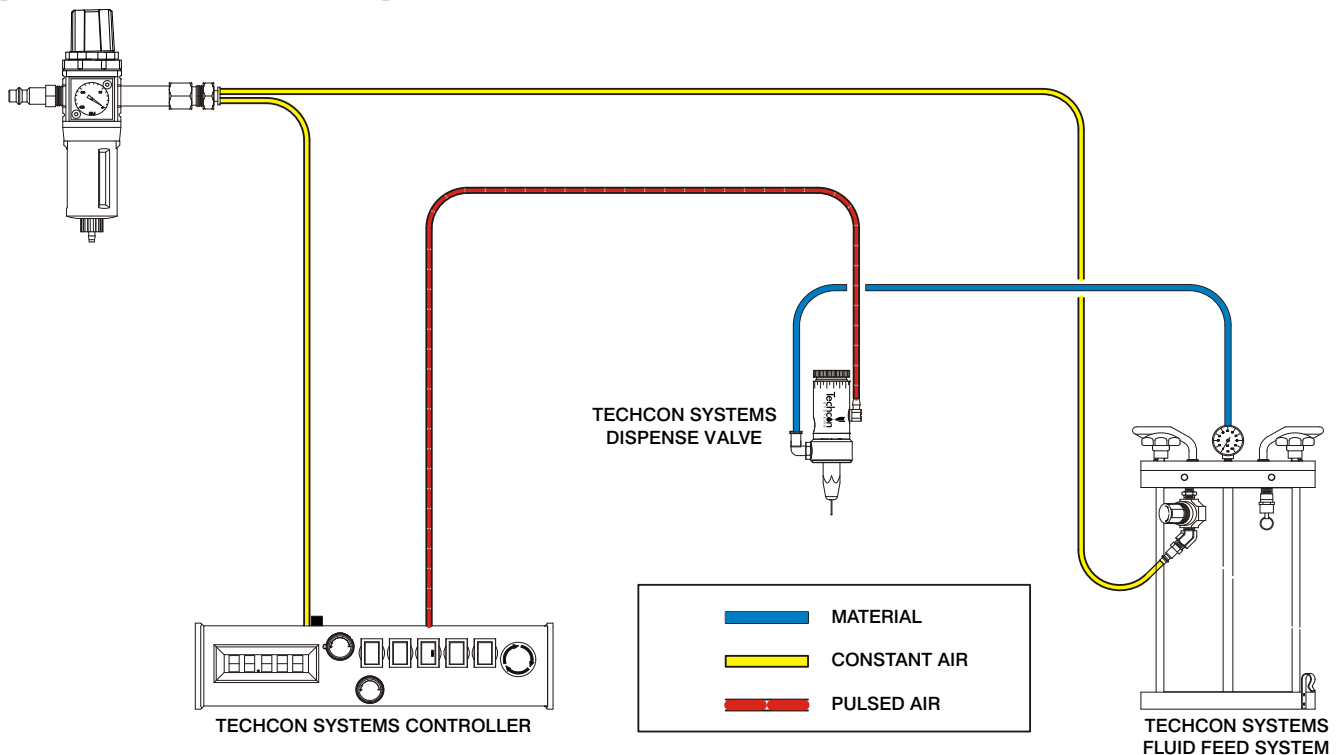

CONTROLLERS



DX-300 Digital Dispenser/Controller

The DX-300 Digital Dispenser/Controller offers the option of programming up to 10 programs. Intuitive to use and allows for reproduction of sequences of beads or dots with high repeatability.

The DX-300 includes an adjustable vacuum feature for controlling drip of fluids between dispense cycles. A vacuum gauge is included to monitor suck-back. Packaged ready to use, with sample tips, barrels and syringe adapters.

Available in two versions of operating pressure: 0 to 100 psi for general applications, and 0 to 15 psi for specific low viscosity applications.

SPECIFICATIONS

Size:	6" x 7" x 6" (15.2 x 17.8 x 15.2 cm)
Voltage:	24V DC power adapter provided
Time Range:	0.008 to 99.99 seconds
CE certified	

DX-300	Digital Dispenser 0 to 100 psi
DX-315	Digital Dispenser 0 to 15 psi

TS5130 Smart Pneumatic Valve Controller

The TS5130 features a fully adjustable Low Pressure Alarm function. This provides process control by preventing dispensing of the process air supply falls below the minimum required for the specific operation.

The TS5130 Valve Controller is designed to offer all the conventional valve control features such as a Valve Purge, Valve Test, External Actuation and End-of-cycle signal. The TS5130 comes equipped with an integrated I/O connector that allows the unit to be connected directly to a computer interface.



SPECIFICATIONS

Size:	9 1/4" x 8 1/2" x 2 1/2" (23.5 x 21.6 x 6.4 cm)
Voltage:	115/230V AC 50/60Hz (selectable)
Operating Pressure:	0 to 100 psi (0.1 to 7 bar)
Time Range:	0.008 to 99.99 seconds
CE certified	



TS5100 Rotary Valve Controller

The TS5100 Controller is the timer/power source for Rotary Valves. It provides an adjustable DC output from 6 to 24 volts, for motor drive and a digital time-set display shows motor on-time, forward and reverse, from 1 millisecond to 99.99 seconds.

Motor activation can be foot switch initiated, or tied to an actuated limit switch. An extra limit switch port is available in "Z" travel relative to dispense cycle. Air adjustment for the syringe feed can be made from the unit's front panel.

SPECIFICATIONS

Size:	12 3/8" x 7 3/8" x 2 1/2" (31.4 x 18.7 x 6.35 cm)
Voltage:	110-120/200-240V AC selectable
Operating Pressure:	0 to 100 psi (0.1 to 7 bar)
Time Range:	0.001 to 99.99 seconds forward and reverse
Output Voltage:	6 to 24V DC adj. (\pm .5%)
CE certified	

TS5110 Spray Valve Controller

The TS5110 Spray Valve Controller offers precision control of Techcon's Spray Valve. Three-stage microprocessor (pre-spray, spray and post-spray) provides accurate and repeatable time control of each stage from .001 to 99.99 seconds.

Continuous spray option offers switch initiated and terminated spray cycles. Precision air regulator provides accurate control of atomizing air pressure. The TS5110 offers footswitch initiated cycles and an I/O port for simple connection to host computer for automated applications.



SPECIFICATIONS

Size:	12 3/8" x 7 3/8" x 2 1/2" (31.4 x 18.7 x 6.4 cm)
Voltage:	110-120V AC 60Hz - 18W 200-240V AC 50Hz - 18W
Time Range:	0.008 to 99.99 seconds
Operating Pressure:	0 to 100 psi (0.1 to 7 bar)
CE certified	

PRODUCT RANGE

Techcon Systems has a full range of fluid dispensing products to meet your application needs.

Besides dispensing valves and equipment, Techcon Systems has a full line of fluid dispensing consumables and packaging products that are available in a complete range of sizes, styles and materials, including UV-blocking colors. Techcon Systems products conform to global industry standards, and meet today's high standards of precision and performance.

For more information about the full scope of fluid dispensing products available, please contact your local Techcon Systems Representative.



TECHCON YOUR LIQUID ASSET

To meet the needs of customers throughout the world, Techcon Systems, an OK International brand, has sales, service and distribution centers in North America, Europe and Asia. Drawing on its organizational strengths and industry experience, Techcon's distribution network offers seamless, proactive support and access to the company's full range of products - around the globe.

Wherever industrial manufacturing facilities are located, Techcon's network of expertly trained distributors is there, to supply essential technical support and advanced process solutions.



NORTH AMERICA

12151 Monarch Street
Garden Grove,
California 92841
USA
Tel: +1-714-799-9910
Fax: +1-714-799-9533

UNITED KINGDOM

OK International Ltd.
Eagle Close, Chandlers Ford
Eastleigh, Hampshire SO53 4NF
United Kingdom
Tel: +44 (0) 2380 489100
Fax: +44 (0) 2380 489109

TAIWAN

OK International Taiwan Ltd.
5th floor, No. 79, Sec 1
Hsin Tai Wu Road, Hsi-Chih
Taipei Hsien,
Taiwan, R.O.C.
Tel: +886-2-26984013
Fax: +886-2-26984021

FRANCE

OK International SAS
Rue de la Saone
Zac de Follieuses-les Echets
01706 Miribel Cedex
France
Tel: +33 (0)4 72 26 20 30
Fax: +33 (0)4 72 26 20 35

CHINA

OK Electronics (Beijing)
Co.,Ltd.
No. 1 Building,
A -10 Long Qing Street
Beijing Economic &
Technical Developing Zone
Beijing, 100176
The People's Republic
of China
Tel: +86-10-67878490
Fax: +86-10-67878491

GERMANY

OK International GmbH
Frankfurter Straße 74
64521 Gross-Gerau
Germany
Tel: +49 (0) 61 52-71 12-0
Fax: +49 (0) 61 52-71 12-22

ITALY

OK International
Strada Statale 11 - No 28
20010 Vittuone, Milano
Italy
Tel: +39 02 902 5161
Fax: +39 02 901 11147

SINGAPORE

OK International
10 Ang Mo Kio St. 65
#05-13 Techpoint
Singapore 569059
Tel: +65-62810991
Fax: +65-62853473

JAPAN

OK International Japan Co.
5-3-1 Heiwajima, Ota-ku
Tokyo 143-0006
Japan
Tel: +81-3-5753-0085
Fax: +81-3-3765-8855



Your Liquid Asset

North America

12151 Monarch Street

Garden Grove, California 92841 USA

Tel: +1-714-799-9910

Fax: +1-714-799-9533

www.techconsystems.com



BRO-V-TEC-US-04